

Free Research-based resources from
the MSKTC to support individuals with

Spinal Cord Injury

Edition 10
May 2024



www.MSKTC.org/SCI



Resources Offered by the MSKTC To Support Individuals Living With Spinal Cord Injury

Edition 10
May 2024

Copyright © 2024 Model Systems Knowledge Translation Center (MSKTC). May be reproduced and distributed freely with appropriate attribution. Prior permission must be obtained for inclusion in fee-based materials.

The contents of this document were developed under grants from the National Institute on Disability, Independent Living, and Rehabilitation Research (NIDILRR), grant numbers 90DP0082 and 90DPKT0009. NIDILRR is a Center within the Administration for Community Living (ACL), U.S. Department of Health and Human Services (HHS). The contents of this document do not necessarily represent the policy of NIDILRR, ACL, and HHS, and you should not assume endorsement by the Federal Government.

Model Systems Knowledge Translation Center

American Institutes for Research
1400 Crystal Drive, 10th Floor
Arlington, VA 22202-3231

www.MSKTC.org

MSKTC@air.org

Phone: 202-403-5600

TTY: 877-334-3499

Connect with us on



Facebook: Spinal Cord Injury Model Systems



Twitter: SCI_MS

About the Model Systems Knowledge Translation Center

The Model Systems Knowledge Translation Center (MSKTC) summarizes research, identifies health information needs, and develops information resources to support the Model Systems programs in meeting the needs of individuals with spinal cord injury (SCI), traumatic brain injury (TBI), and burn injury (Burn). The health information offered through the MSKTC is not meant to replace the advice from a medical professional. Users should consult their health care provider regarding specific medical concerns or treatment. The current MSKTC cycle is operated by American Institutes for Research® (AIR®). The Center is funded by the U.S. Department of Health and Human Services (HHS), National Institute on Disability, Independent Living, and Rehabilitation Research (NIDILRR) under grant number 90DPKT0009. To learn more, visit <http://www.msktc.org>.

About the Model Systems Program

Model Systems are specialized programs of care in spinal cord injury (SCI), traumatic brain injury (TBI), and burn injury (Burn). Model Systems conduct innovative and high-quality research, provide patient care, and offer other services to improve the health and overall quality of life for individuals with SCI, TBI, and burn injury. Model Systems are funded by the U.S. Department of Health and Human Services (HHS), National Institute on Disability, Independent Living, and Rehabilitation Research (NIDILRR).

To learn more about the Spinal Cord Injury Model System centers, please visit:

<https://msktc.org/sci/model-system-centers>.

About the National Spinal Cord Injury Statistical Center

The National Spinal Cord Injury Statistical Center (NSCISC) supports and directs the collection, management and analysis of the world's largest and longest spinal cord injury research database. Organizationally, NSCISC is currently the hub of the network of 18 NIDILRR-sponsored Spinal Cord Injury Model Systems and 5 subcontracts at formerly funded Model Systems located at major medical centers throughout the United States.

In addition to maintaining the national SCI database, NSCISC personnel conduct ongoing, database-oriented research. Many of the findings resulting from these investigative efforts have had significant impact on the delivery and nature of medical rehabilitation services provided to SCI patients.

The NSCISC is operated by the UAB Department of Physical Medicine and Rehabilitation and is funded by the U.S. Department of Health and Human Services (HHS), National Institute on Disability, Independent Living, and Rehabilitation Research (NIDILRR).

<https://www.nscisc.uab.edu/>

Contents

Overview of MSKTC Spinal Cord Injury Products Offered Through the MSKTC.....	4
Opportunities to Participate in MSKTC Activities	5
Collection of Spinal Cord Injury Factsheets Offered by the MSKTC, Volume I.....	7
Depression and Spinal Cord Injury	8
Employment after Spinal Cord Injury	11
Safe Transfer Technique.....	15
Skin Care & Pressure Sores (7 Part Series)—Part 1: Causes and Risks of Pressure Sores	17
Skin Care & Pressure Sores (7 Part Series)—Part 2: Preventing Pressure Sores	19
Skin Care & Pressure Sores (7 Part Series)—Part 2: Preventing Pressure Sores Supplement: Areas at high risk of developing pressure sores	23
Skin Care & Pressure Sores (7 Part Series)—Part 2: Preventing Pressure Sores Supplement: Building skin tolerance for pressure	24
Skin Care & Pressure Sores (7 Part Series)—Part 2: Preventing Pressure Sores Supplement: How to do pressure reliefs (weight shifts)	25
Skin Care & Pressure Sores (7 Part Series)—Part 3: Recognizing and Treating Pressure Sores	28
Skin Care & Pressure Sores (7 Part Series)—Part 3: Recognizing and Treating Pressure Sores Supplement: Stages of Pressure Sores: Illustrations	30
Spasticity and Spinal Cord Injury	32
Spinal Cord Injury and Gait Training	35
The Wheelchair Series: What the Spinal Cord Injury Consumer Needs to Know (3 Part Series) Getting the Right Wheelchair: What the SCI Consumer Needs to Know.....	39
The Manual Wheelchair: What the SCI Consumer Needs to Know.....	42
The Power Wheelchair: What the SCI Consumer Needs to Know.....	45
Collection of Spinal Cord Injury Factsheets Offered by the MSKTC, Volume 2.....	48
A Guide to Inpatient Rehabilitation Services for People with Spinal Cord Injury	49
Adaptive Sports and Recreation	58
Adjusting to Life After Spinal Cord Injury.....	64
Aging With a Spinal Cord Injury.....	70
Autonomic Dysreflexia.....	75
Bladder Management Options Following Spinal Cord Injury.....	79
Bone Loss After Spinal Cord Injury	86
Bowel Function After Spinal Cord Injury.....	89
Driving After Spinal Cord Injury	93
Exercise After Spinal Cord Injury	97
Maintenance Guide for Users of Manual and Power Wheelchairs.....	104
Nutrition and SCI	113
Opioids and Your Health.....	121
Pain after Spinal Cord Injury	127
Pain after Spinal Cord Injury: Activity Modification for Musculoskeletal Pain.....	134
Personal Care Attendants and Spinal Cord Injury	138
Pregnancy and Women with Spinal Cord Injury	145
Respiratory Health and Spinal Cord Injury.....	149
Sexuality & Sexual Functioning After Spinal Cord Injury	153
Surgical Alternatives for Bladder Management Following SCI.....	157
Surgical and Reconstructive Treatment of Pressure Injuries	161
Understanding Spinal Cord Injury—Part 1: The Body Before and After Injury	168
Understanding Spinal Cord Injury—Part 2: Recovery and Rehabilitation.....	172
Urinary Tract Infection and Spinal Cord Injury.....	182

Overview of MSKTC Spinal Cord Injury Products Offered Through the MSKTC

The Model Systems Knowledge Translation Center (MSKTC) offers a variety of free resources on spinal cord injury (SCI) to support people with disabilities and their caregivers, researchers, practitioners and clinicians, and policy makers. The following resources are available at www.MSKTC.org/SCI.

SCI Factsheets

The MSKTC collaborates with SCI Model Systems to produce evidence-based and consumer-friendly factsheets.

SCI Slideshows

The MSKTC develops traditional and narrated slideshows based on information from select factsheets. These resources are developed for users who prefer a format with more images, less text, or an audio option.

SCI Hot Topic Modules

The MSKTC develops Hot Topic Modules, which are a collection of resources such as videos, factsheets, and slideshows to support individuals who live with SCI.

SCI Quick Research Reviews

The MSKTC provides quick review of Model Systems research studies funded by the National Institute on Disability, Independent Living, and Rehabilitation Research (NIDILRR). Those reviews offer timely summaries of newly released model system research studies using lay language for easy access.

SCI Systematic Reviews

The MSKTC collaborates with Model System programs to conduct systematic reviews on high-priority health topics to inform clinical practice. Results of a systematic review provide the best information for making decisions about treatment, practice or behavior.

SCI Research Database

The MSKTC maintains a database of more than 800 SCI citations and abstracts of studies funded by NIDILRR.

SCI Infocomics

Information based on consumer factsheets, presented in a comic-styled storyboard format

SCI Infographics

Data and information presented visually for easy comprehension.

SCI Online Course

Self-paced courses that teach researchers, consumers, clinicians and others to manage SCI conditions.

Opportunities to Participate in MSKTC Activities

Involvement from the field plays a critical role in the success of the MSKTC. Periodically, we recruit individuals with spinal cord injury and their family members, caregivers, and clinicians to participate in MSKTC activities. We sometimes offer a small financial token of appreciation to participants. Examples of activities include:

- ◆ Providing feedback on factsheets
- ◆ Offering input on videos
- ◆ Participating in a conversation about the needs of those with spinal cord injury and their supporters

If you are interested in learning more about these activities or participating, please email MSKTC@air.org or call 202-403-5600.

Collection of SCI Factsheets Offered by the MSKTC

This section contains SCI factsheets offered by the MSKTC as of August 2022. These and other resources are available at no charge on [MSKTC.org/SCI](https://www.msktc.org/SCI).

Volume 1: Factsheets Developed 2007–2012

- ◆ Depression and Spinal Cord Injury
- ◆ Employment after Spinal Cord Injury
- ◆ Safe Transfer Technique
- ◆ Skin Care and Pressure Sores (7 Part Series)
- ◆ Spasticity and Spinal Cord Injury
- ◆ Spinal Cord Injury and Gait Training
- ◆ The Wheelchair Series: What the SCI Consumer Needs to Know (3 Part Series)

Volume 2: Factsheets Developed 2012–2024

- ◆ A Guide to Inpatient Rehabilitation Services for People with Spinal Cord Injury
- ◆ Adaptive Sports and Recreation
- ◆ Adjusting to Life After Spinal Cord Injury
- ◆ Aging With a Spinal Cord Injury
- ◆ Autonomic Dysreflexia
- ◆ Bladder Management Options Following Spinal Cord Injury
- ◆ Bone Loss After Spinal Cord Injury
- ◆ Bowel Function After Spinal Cord Injury
- ◆ Driving After Spinal Cord Injury
- ◆ Exercise After Spinal Cord Injury
- ◆ Maintenance Guide for Users of Manual and Power Wheelchairs
- ◆ Nutrition and SCI
- ◆ Opioids and Your Health
- ◆ Pain after Spinal Cord Injury
- ◆ Pain after Spinal Cord Injury: Activity Modification for Musculoskeletal Pain
- ◆ Personal Care Attendants and Spinal Cord Injury
- ◆ Pregnancy and Women with Spinal Cord Injury
- ◆ Respiratory Health and Spinal Cord Injury
- ◆ Sexuality & Sexual Functioning After Spinal Cord Injury
- ◆ Surgical Alternatives for Bladder Management Following SCI
- ◆ Surgical and Reconstructive Treatment of Pressure Injuries
- ◆ Understanding Spinal Cord Injury: Part 1—The Body Before and After Injury
- ◆ Understanding Spinal Cord Injury: Part 2—Recovery and Rehabilitation
- ◆ Urinary Tract Infection and Spinal Cord Injury

Volume 1: Factsheets Developed 2007–2012

Depression and Spinal Cord Injury



For more information, contact your nearest SCI Model System. For a list of SCI Model Systems go to: <http://www.msktc.org/sci/model-system-centers>

This publication was produced by the SCI Model Systems in collaboration with the University of Washington Model Systems Knowledge Translation Center with funding from the National Institute on Disability and Rehabilitation Research in the U.S. Department of Education, grant no. H133A060070.

Depression is common and can affect anyone. About 1 in 20 Americans (over 11 million people) get depressed every year. Depression is even more common in the spinal cord injury (SCI) population—about one in five people. Estimated rates of depression among people with SCI range from 11% to 37%.

What is depression?

Depression is not just “feeling blue” or “down in the dumps.” It is a serious medical disorder (just like diabetes, in which both biology and behavior can help or hurt). Depression is closely linked to your thoughts, feelings, physical health and daily activities. Depression affects both men and women. Depression can cause some or all of the following physical and psychological symptoms:

- Changes in sleep (too much or too little)
- Feeling down or hopeless
- Loss of interest or pleasure in activities
- Changes in appetite
- Diminished energy or activity
- Difficulty concentrating or making decisions
- Feelings of worthlessness or self-blame
- Thoughts of death or suicide

Periods of sadness are normal after SCI. However, there is cause for concern when feeling depressed or losing interest in usual activities occurs almost daily and lasts for more than two weeks. Depression is not caused by personal weakness, laziness or lack of will power.

Causes of depression

Although we don't know for sure what causes depression, we do know that life stresses and medical problems can cause a change in certain brain chemicals, called neurotransmitters. This chemical imbalance is linked to changes in mood, enjoyment, sleep, energy, appetite and ability to concentrate.

Depression can and should be treated

The good news is that the symptoms of depression can almost always be treated with specific types of counseling or antidepressant medications. However, a combination of both counseling and antidepressant medication has been shown to have the best results. Regular exercise or physical activity can also

improve mood, especially when used together with counseling or medications.

It is important to treat depression because it can have such a harmful effect on a person’s ability to function in day-to-day life. Depression can make pain worse, make sleep difficult, sap your energy, take away your enjoyment and make it difficult for you to take good care of your health.

Untreated depression can last 6 to 12 months or more. Thoughts of death is a symptom of depression. The risk of suicide is higher while someone is depressed. Due to both brain chemistry and thought patterns, often people who have severe depression and suicidal thoughts have difficulty seeing a way out of their problems. Suicidal thinking goes away once depression is treated.

What counseling really is

Counseling or psychotherapy is often misunderstood. There are many different kinds of therapy, but one type that has been proven to help depression is called “cognitive-behavioral therapy.” Cognitive-behavioral therapy is based on the idea that depression improves when people are more engaged in meaningful activities and when they regain their positive beliefs and attitudes about themselves, their world and their future. The therapist helps you find or resume activities that are meaningful or enjoyable to you. There will be barriers to overcome, so the therapist supports you like a coach to help resolve the problems you face. The therapist also helps you recognize how your thinking becomes more negative in depression and how, through experimentation and logic, you can improve your outlook and rebuild confidence.

How do antidepressants work?

Antidepressant medications seem to work by restoring a normal balance of important brain chemicals such as norepinephrine and serotonin. Rebalancing these chemicals leads to feeling better both emotionally and physically. Treating depression can also help you function better at home and at work. Antidepressants are not addictive. Some people get side effects, but they tend to lessen over time.

Depression Self-Test

For each of the nine items listed below, circle the number (0-3) that corresponds to how often you have been bothered by that problem over the past two weeks.

Over the last 2 weeks, how often have you been bothered by any of the following problems?	Not at all	Several days	More than half the days	Nearly every day
1. Little interest or no pleasure in doing things.	0	1	2	3
2. Feeling down, depressed, or hopeless.	0	1	2	3
3. Trouble falling or staying asleep, or sleeping too much.	0	1	2	3
4. Feeling tired or having little energy.	0	1	2	3
5. Poor appetite or over-eating.	0	1	2	3
6. Feeling bad about yourself or that you are a failure or have let yourself or your family down.	0	1	2	3
7. Trouble concentrating on things, such as reading the newspaper or watching television.	0	1	2	3
8. Moving or speaking so slowly that other people could have noticed. (Or the opposite: being so fidgety or restless that you have been moving around a lot more than usual.)	0	1	2	3
9. Thoughts that you would be better off dead or of hurting yourself in some way.	0	1	2	3

Copyright © 2005 Pfizer, Inc. All rights reserved. Reproduced with permission.

What you can do

1. Take a “depression self-test” like the one above.
2. Answer all the questions honestly, add up your score and see where your score falls.
3. If your score is 10 or higher and you have been feeling this way for more than a week or two, contact your health care provider or

a psychologist, psychiatrist or counselor who has experience treating depression.

4. If you are having thoughts of death or suicide, contact your health care provider or a mental health specialist immediately. Also, inform those around you about how badly you are feeling so that they can support you and help keep you safe while you go through this difficult period.

If you are in danger of harming yourself now, please call 911, the 24-hour National Crisis Hotline at 800-273-8255, or your local Crisis Clinic right away.

Remember, depression is not a necessary or inevitable part of living with SCI. In fact, most people with SCI are not depressed. If you are struggling with depression or feeling low for more than two weeks, talk to your doctor. Depression is treatable and beatable.

How to find help

Many mental health professionals are qualified to treat depression. For example, psychiatrists have specialized training in medication management for depression and psychologists are trained to provide counseling for depression.

Other physicians, such as primary care physicians, neurologists and physiatrists, and nurse practitioners with experience in treating depression can often get treatment started and refer you to mental health professionals as needed.

When available, seek treatment from a comprehensive spinal cord injury rehabilitation program that can address all aspects of SCI recovery.

Source

Our health information content is based on research evidence whenever available and represents the consensus of expert opinion of the SCI Model System directors.

Authorship

Depression and Spinal Cord Injury was developed by Charles H. Bombardier, PhD, in collaboration with the University of Washington Model Systems Knowledge Translation Center.

This document was adapted from materials developed by the Northwest Regional SCI System.

Disclaimer

This information is not meant to replace the advice from a medical professional. You should consult your health care provider regarding specific medical concerns or treatment.



Employment after Spinal Cord Injury



For more information, contact your nearest SCI Model System. For a list of SCI Model Systems go to: <http://www.msktc.org/scimodel-system-centers>

This publication was produced by the SCI Model Systems in collaboration with the University of Washington Model Systems Knowledge Translation Center with funding from the National Institute on Disability and Rehabilitation Research in the U.S. Department of Education, grant no. H133A060070.

Most people with spinal cord injuries (SCI) want to work yet need support, training and vocational rehabilitation services to help them obtain and keep a job. These sources of support may help to overcome many barriers that are outside the individual's control, such as financial and health care issues, accessibility, and employer attitudes.

Work is important to people not only because they can earn an income and receive health insurance and other benefits, but also because it gives them opportunities to interact with others and improved self-esteem and overall life satisfaction. And although there is no cause-effect relationship, there are consistent findings in the research that people who are employed after SCI live longer and report higher satisfaction with life and better health than people who are not working.

Although individuals with SCI can and do go on to have active work lives and successful careers, they have more barriers to overcome than those without disabilities. Federal and state laws and vocational rehabilitation services exist to help people with disabilities overcome these barriers.

The law protects you

Passed in 1990 and amended in 2008, the federal Americans with Disabilities Act (ADA) prohibits employers from discriminating against qualified individuals with disabilities who are able to perform the essential functions of the job with or without accommodation.

- To be protected under this law, you must have a disability that limits major life activities. Nearly all people with SCI are protected under ADA.
- An employer must make "reasonable accommodation" to your disability if it would not impose an undue hardship on the business. Whether an accommodation is considered a "hardship" depends on the business size, financial resources, nature of operation and other factors.
- When you apply for a job, an employer cannot ask you about the existence, nature or severity of your disability, even if you show up for your interview in a wheelchair. An employer can ask you about your ability to perform certain job functions.
- An employer can require you to pass a medical examination **only** if it is job-related and required of **all** employees in similar jobs.
- If you feel an employer has discriminated against you, contact the U.S. Equal Employment Opportunity Commission (EEOC). Call 800-669-4000 to find the office nearest you, or go to www.eeoc.gov. Many states have powerful disability rights laws as well.

The Individuals with Disabilities Education Act (IDEA) is a law that helps young people who have not yet finished their K-12 education receive the services they need to meet their academic and vocational goals and to ensure a smooth transition into adult life. Students eligible under this law may remain in school until age 22 if the extra time is necessary to achieve their goals. For more information, contact the U.S. Department of Education (800-872-5327) or visit the IDEA 2004 website at <http://idea.ed.gov/>.

What is vocational rehabilitation?

Vocational rehabilitation programs can help individuals with disabilities obtain employment. Through these programs, a wide range of services are available to help people identify their career interests and skills; acquire the relevant education or training; find and apply for jobs; and get work accommodations. For people who are covered under worker's compensation (because they were injured on the job), a similar set of vocational rehabilitation programs are often available.

Who pays?

- **Some private health insurance companies** pay for vocational rehabilitation services. Check with your insurer to find out what services are covered.
- **State vocational rehabilitation programs** are funded (through federal mandate) to provide free vocational rehabilitation services for anyone with a significant disability that limits their ability to work. Services include all the steps in the vocational rehabilitation process described in this factsheet.
- **State workers' compensation programs** provide free vocational rehabilitation services for individuals who have been injured on the job.
- **The Veterans Administration (VA)** provides vocational rehabilitation services to eligible beneficiaries with service related disabilities.

How does vocational rehabilitation work?

Vocational rehabilitation can take place at any time an individual with a disability needs help finding or keeping employment. If you are not

working but are interested in finding employment, or if you are dissatisfied with your current job, you might try vocational rehabilitation.

Whenever the process begins, it includes the following steps:

Getting started

Your rehabilitation medicine physician can refer you to a vocational rehabilitation program, or you can find these services yourself by visiting <http://askjan.org/cgi-win/TypeQuery.exe?902> for a listing of the State Vocational Rehabilitation offices.

In many settings, vocational rehabilitation services are provided by rehabilitation counselors with master's degrees who are specially trained to help people with disabilities find and keep employment.

Assessment

Finding satisfying employment means matching your interests and needs with the characteristics and demands of jobs. Being able to find and maintain employment will also depend on your abilities to meet the requirements of the jobs that are available in the job market or your current job.

Your rehabilitation counselor will begin by helping you to evaluate your interests, skills, limitations, health needs, work and education histories, and even personality style. The counselor gets this information through interviews, questionnaires, medical information from your physician, and sometimes tests of academic aptitude and skills. Your counselor may also set up real life opportunities for you to find out more about various jobs.

Real-life "tests"

Your rehabilitation counselor may be able to set up a "trial" work situation for you with a potential employer for a specified period of time to see if you are able to do the job, if you like the job, and what accommodations you might need. These situations may be paid or unpaid. After the trial period, both you and the employer can decide whether it will be a good long-term fit.

The job market

Part of the process may be assessing the job market related to various occupations. You may be interested in a specific job in a particular industry

but if that industry is declining or does not have opportunities in your geographic area, you might need to look into something different. Your rehabilitation counselor can help you assess the job opportunities in your area, as well as the wages, tasks, education preparation and other characteristics of occupations you might be interested in.

Setting goals

The end-product of the rehabilitation counseling process is deciding on the specific career or occupation you want to pursue. This is your long-term goal. To get there, you may need to complete several intermediate steps along the way. These steps should be described in as much detail as possible in a written plan that you and your rehabilitation counselor create together.

For example, you may need to finish high school or attend college to enter the occupation of your choice, or perhaps you can go right to work. To do either, you may need to increase your physical endurance, find reliable accessible transportation and accessible housing, and manage your medical needs so you can meet the demands of a job schedule.

Landing a job

After thorough preparation and planning, people with SCI often secure jobs on their own. Sometimes they need extra help, however. A rehabilitation counselor can help you determine whether a potential job would be a good match for you. He or she can conduct a job analysis to determine the actual kinds of tasks done in that particular job, the cognitive (thinking), social and physical demands of the job, and the need for accommodations. A job placement specialist can help you identify specific opportunities in your geographic area.

Discrimination in hiring is illegal even if it is not intentional. Employers with no experience interacting with people who have disabilities may assume someone with a disability cannot do the work or hold down a job. In these cases, a rehabilitation counselor can step in and work with the employer to overcome prejudices and suggest accommodations that improve the employer's comfort in hiring a person with a disability.

Getting support at work

You may need ongoing support and accommodations at work. Someone with high-level tetraplegia, for example, may need help with positioning or personal care assistance during the work day. These are typically not paid for by the employer, and a source of funding for this assistance must be identified in advance.

Types of accommodations

Job accommodations can include modifying work schedules, tasks or the work environment. Solutions can range from simple to high-tech.

Examples:

- Removing a desk drawer or raising the height of a desk with four wood blocks so a wheelchair can fit underneath.
- Special software and hardware so a person with no hand function can work on a computer.
- A private changing area for someone who may have occasional bladder accidents.
- Shifting work hours to a later start and end to the work day to accommodate a worker's lengthy morning care needs.
- If a person has both SCI and a brain injury, he or she may need additional support in the form of extra supervision or job "coaching."

A rehabilitation counselor can help determine what kinds of accommodations might be helpful and whether they constitute "undue hardship" for the employer.

Work vs. benefits: finding a balance

Sometimes people are reluctant to start working because they don't want to lose their medical benefits under Social Security Disability Insurance (SSDI), Supplementary Security Income (SSI), or private or state long-term disability insurance (LTD). They may also be concerned about the extra costs of getting to or staying at work.

Federal work incentive programs under SSDI or SSI allow people with disabilities to receive benefits and federal health care (Medicare and/or Medicaid) while still keeping some of their earnings from employment. This can be a powerful

incentive for someone with a high-level SCI who has a strong desire to work but needs personal care assistance on the job, must pay for a van, and needs other services in order to work. Some LTD policies include vocational rehabilitation benefits or incentives to return to work.

Work-incentive programs are complicated, and you may want to consult your vocational rehabilitation counselor, a resource specialist with an independent living center, or a social worker familiar with benefits systems. (Also see “Resources,” below.)

If employment is not possible

Sometimes it is not possible for a person to obtain any kind of work after SCI. This includes people who cannot earn enough by working to pay for their own personal care assistance and other disability costs. People who live in rural areas may not have access to transportation or employment. Older workers may not be able to transfer their pre-injury skills to a new occupation. In these cases, the individual can apply for disability benefits with the help of the rehabilitation counselor or other health provider.

A person is eligible to receive disability payments from the Social Security Administration (SSA) if he or she is unable to perform any kind of work at a level of “substantial and gainful” activity and the disability is expected to last at least a year.

The SSA pays disability benefits under two programs:

- **Social Security Disability Insurance (SSDI)** is a long-term disability insurance program funded by payroll taxes. Eligibility is based on your past work history and income.
- **Supplemental Security Income (SSI)** is a federal welfare program for people with disabilities who are unable to work and are low income.

Newly injured individuals with SCI should apply for SSA benefits immediately if it seems likely that they will not return to work for at least a year. Sometimes there is a waiting period before starting to receive benefits. Once enrolled, a person is immediately eligible for either state Medicaid benefits or, after a waiting period, for federal Medicare benefits.

The case for volunteering

If paid employment is not possible, consider getting involved in a volunteer activity. Not only can volunteering provide enjoyment and a sense of accomplishment, it can give you the skills, confidence and professional contacts that might eventually lead to paid employment some day.

Reference

Johnson, K. (2009). Vocational Rehabilitation (pp. 715–722). In V. Lin (Ed.), *Spinal cord medicine: Principles and Practice*. New York: Demos.

Resources

- Benefits for People with Disabilities, Social Security Administration: <http://www.ssa.gov/disability/>
- Find your local Vocational Rehabilitation Agency, Job Accommodation Network, U.S. Department of Labor: <http://askjan.org/cgi-win/TypeQuery.exe?902>
- The Red Book: A Guide to Work Incentives, Social Security Administration: <http://www.socialsecurity.gov/redbook/>
- Social Security Area Work Incentive Coordinators (AWIC) provide information about work incentive programs. You can find the AWIC in your area at <http://www.ssa.gov/work//awiccontacts.html>.

Source

Our health information content is based on research evidence whenever available and represents the consensus of expert opinion of the SCI Model System directors and staff.

Authorship

Employment after Spinal Cord Injury was developed by Kurt Johnson, PhD and Jim Krause, PhD, in collaboration with the University of Washington Model Systems Knowledge Translation Center.

Disclaimer

This information is not meant to replace the advice from a medical professional. You should consult your health care provider regarding specific medical concerns or treatment.

Safe Transfer Technique



For more information, contact your nearest SCI Model System. For a list of SCI Model Systems go to: <http://www.msktc.org/scimodel-system-centers>

This publication was produced by the SCI Model Systems in collaboration with the University of Washington Model Systems Knowledge Translation Center with funding from the National Institute on Disability and Rehabilitation Research in the U.S. Department of Education, grant no. H133A060070.

Transferring in and out of your wheelchair puts higher stress on your arms and shoulders than anything else you do on a regular basis. Learning the correct way to transfer is extremely important in order to keep your arms functioning and pain-free.

Get proper transfer training

- Everyone needs individualized transfer training to preserve function and avoid injury. Work with a physical therapist to learn the best transfer technique for you and your body.
- Your transfer technique may need to be readjusted as years go by. If you develop any problems or if your living circumstances (e.g. pregnancy) or activities change, go back to your therapist for advice.

Safe transfer rules and technique

- Frequency – Only transfer when necessary, keeping the number of transfers to a minimum.
- Transferring downhill is easier and, at modest height, safer than transferring uphill.
- Technique – Steps (These are general steps. Work with your therapist to fine tune them for you.):
 - Positioning/setup
 - Get as close as possible to the surface you want to move to.
 - Lock your wheels if transferring from a wheelchair.
 - Put your feet on floor (unless your therapist tells you not to).
 - Scoot to the edge of your chair.
 - Get your arm rest out of the way on the side next to the surface you are transferring to.



continued on page 2

- Lean your trunk forward.
 - When transferring, your head should move in the opposite direction of your hips. This is known as a head-hips relationship and can help with movement and clearing obstacles.
- To protect your shoulders, keep your arms as close to your body as possible (about 30–45 degrees away from your body) while you are lifting your weight.
- To protect your wrists, try to grip an edge or grab bar with your fingers rather than laying your hands flat. Keeping your hands flat and putting your weight on your palms is a dangerous position that can lead to wrist problems such as carpal tunnel syndrome down the road.
- Lift-off
 - Make sure you are clearing obstacles (not bumping or rubbing) to avoid shearing and pressure sores.
 - If you cannot perform the transfer in one smooth movement while keeping your arms close to your body, move in several small “steps” and/or use a transfer board.
 - Be careful sliding across the transfer board because the motion can damage your skin. Use a pad or towel on the board when bare skin may come in contact with the board during the transfer.
- Alternate leading arms and direction of transfers to keep your arm muscles balanced and reduce strain on one side.
- Maintain ideal body weight. The more you weigh, the more weight you have to transfer and the more stress you put on your shoulders and arms.
- If you are unable to perform a transfer safely or are at risk for developing arm pain, you should strongly consider using one of the many kinds of patient lifts available.

Resources

Consortium for Spinal Cord Medicine. *Preservation of Upper Limb Function: What You Should Know. A Guide for People with Spinal Cord Injury, Paralyzed Veterans of America, 2008.*

Source

Our health information content is based on research evidence whenever available and represents the consensus of expert opinion of the SCI Model System directors.

Authorship

Safe Transfer Technique was developed by Michael L. Boninger, MD, in collaboration with the University of Washington Model Systems Knowledge Translation Center.

Disclaimer

This information is not meant to replace the advice from a medical professional. You should consult your health care provider regarding specific medical concerns or treatment.



Spinal Cord Injury Model System
SCIMS | NIDRR
A NIDRR Funded Program

Skin Care & Pressure Sores

Part 1: Causes and Risks of Pressure Sores



For more information, contact your nearest SCI Model System. For a list of SCI Model Systems go to: <http://www.msktc.org/sci/model-system-centers>

This publication was produced by the SCI Model Systems in collaboration with the University of Washington Model Systems Knowledge Translation Center with funding from the National Institute on Disability and Rehabilitation Research in the U.S. Department of Education, grant no. H133A060070.

What do I need to know?

- Individuals with SCI are at high risk for developing pressure sores.
- **Pressure sores can be life threatening.**
- Possible complications:
 - Infections can develop and spread to the blood, heart and bone.
 - Amputations
 - Prolonged bed rest necessary for healing can keep you out of work, school and social activities for months.
 - Because you are less active when healing a pressure sore, you are at higher risk for respiratory problems and urinary tract infections.
 - Treatment can be very costly in lost wages or additional medical expenses.
- Up to 80% of individuals with SCI will have a pressure sore during their lifetime, and 30% will have more than one pressure sore.
- Most pressure sores are preventable.

What is a pressure sore?

A pressure sore (also called pressure ulcer, decubitus ulcer, decubiti (plural), bedsore or skin breakdown) is an area of the skin or underlying tissue (muscle, bone) that is damaged due to loss of blood flow to the area. Blood flow to the skin keeps it alive and healthy. If the skin does not get blood, it will die.

Why do pressure sores happen?

Normally the nerves send messages of pain or discomfort to your brain to let you know when to move to relieve pressure, stay away from hot surfaces, or shift your weight. After injury, messages from the sensory nerves may not normally reach the brain. With little or no feeling, you have no warning signs to tell you that you have been in one position too long and that something is pressing against your skin causing it harm.

How do pressure sores happen?

- **Too much pressure on the skin for too long**, as in sitting or lying too long in one position. Unrelieved pressure is the most common cause of pressure sores in SCI. The extended pressure cuts off the blood supply to the skin, leading to tissue damage, skin breakdown and a pressure sore. Common high-pressure situations:
 - Sitting too long without shifting weight.
 - Lying too long without turning.
 - Not enough padding in bed (to protect bony areas of the body, such as the heels).

- Clothing and shoes that fit too tightly.
- Sitting or lying on hard objects, such as catheter connectors and clamps, bulky seams, or buttons on mattresses.
- **Shearing** occurs when the skin moves one way and the bone underneath it moves another way. This can result from slouching while sitting, sitting at a 45 angle (as in bed), or sliding during a transfer instead of lifting your body. Shearing can also happen during spasms.
- **Trauma** of any kind (cuts, bumps, burns, scrapes, rubbing)
 - **Abrasion or friction:** Cut or scratch; sliding across sheets or transfer board with bare skin.
 - **Bump or fall:** Bumping toes into doorways; bumping your buttocks off the tire during transfers; bumping knees under desks.

What puts me at risk of getting a pressure sore?

- **Loss of muscle mass.** With paralysis the muscles tend to shrink, become less bulky and get smaller (atrophy). Muscle mass or bulk serves as a natural cushion over the bony areas. A decrease in muscle mass leads to less protection over bony surfaces and more pressure on the thin skin layers.
- **Being over- or underweight.** When you are underweight, you have less natural padding to protect your body areas, so your skin can break down from even small amounts of pressure. But when you are overweight, it is harder to shift your weight and do pressure reliefs, and all that fat uses oxygen and nutrients that could be nourishing your skin.
- **Decreased circulation.**
 - **Blood flow to the paralyzed limbs decreases** due to the lack of muscle movement and results in less nutrients and oxygen getting to the skin. The skin does not heal well if there is poor circulation.
 - **Edema or swelling** is caused by fluid collecting in the tissues, usually in a part of the body that is not moved frequently and is below the level of the heart (feet, legs and hands). Skin over areas of edema becomes thin and pale and injures easily.

- **Smoking** is terrible for your circulation.
- **Diabetes, high blood pressure and high cholesterol** decrease circulation. If you have these diseases, pay particular attention to your feet and ankles. They are farthest away from the heart and are likely to be affected first or worst.
- **Illness or poor overall health.** This includes fevers, infections (such as UTIs), poor nutrition, and chronic diseases such as diabetes.
- **Moisture.** Wet skin (from urine, stool, sweat, water) is more likely to break down.
- **Dry, flaky skin** can crack and become inflamed and infected.
- **Ageing** causes skin to become thinner, dryer, and more fragile. You may need to adjust your pressure relief schedule or switch to a different type of cushion when you get older.
- **Previous skin breakdown.** Scar tissue is more fragile than normal skin.
- **Spasticity** can cause your arms or legs to bump against an object and be injured, or rub against a surface (such as the sheets on your bed), which could produce an open sore.
- **Extreme heat or cold.**
- **Alcohol (or drug) use** often causes people to neglect their pressure reliefs and other personal care needs.
- **Depression** is also a risk factor for developing pressure sores.

Source

Our health information content is based on research evidence and/or professional consensus and has been reviewed and approved by an editorial team of experts from the SCI Model Systems.

Authorship

This brochure was developed by the SCI Model System Dissemination Committee in collaboration with the University of Washington Model Systems Knowledge Translation Center.

More in the Skin Care & Pressure Sores series:

- Part 2: Preventing Pressure Sores
 - Supplements:*
 - How to do Pressure Reliefs (Weight Shifts)
 - Building Skin Tolerance for Pressure
 - Areas of the Body at High Risk for Pressure Sores
- Part 3: Recognizing and Treating Pressure Sores
 - Supplements:*
 - Stages of Pressure Sores: Illustrations

Skin Care & Pressure Sores

Part 2: Preventing Pressure Sores



For more information, contact your nearest SCI Model System. For a list of SCI Model Systems go to:
<http://www.msktc.org/sci/model-system-centers>

This publication was produced by the SCI Model Systems in collaboration with the University of Washington Model Systems Knowledge Translation Center with funding from the National Institute on Disability and Rehabilitation Research in the U.S. Department of Education, grant no. H133A060070.

What do I need to know?

- Ninety-five percent of all pressure sores are preventable!
- After spinal cord injury, your skin requires daily care and a lot of attention.
- You will need to spend time daily cleaning the skin, keeping it dry (from incontinence or perspiration), checking the skin for problems or changes, moving yourself so the skin will get proper blood supply, and drinking and eating properly so the skin can stay healthy.

How can I avoid getting a pressure sore?

Do regular pressure reliefs (also called weight shifting, pressure redistribution and pressure reduction)

- Pressure relief is moving or lifting yourself to take the pressure off areas that have been under pressure, usually from sitting or lying in one position, so blood can circulate.
- When sitting in your wheelchair you should do pressure reliefs every 15 to 30 minutes for a duration of at least 30 to 90 seconds. Continue to perform pressure reliefs when sitting in a car or on other surfaces (such as on sports equipment). [For more information, read the fact sheet on “How to do Pressure Reliefs (Weight Shifts).”]
- If you are unable to perform a pressure relief independently, instruct the person who helps you with your daily care (family, attendant) to consistently, routinely move you and reduce pressure over areas at risk for pressure sores.
- Your therapist or nurse will teach you how to do pressure reliefs before you leave the hospital. The methods and timing of pressure reliefs will vary somewhat according to your injury and skin tolerance.
- Each person’s skin tolerance is different. Some people may need to relieve pressure very often, others may not need to do it very often—but they still need to do it! Building skin tolerance is a gradual process. [For more information, read the fact sheet on “Building Skin Tolerance for Pressure.”]
- For pressure relief at night, see the recommendations described in “Padding, positioning and turning in bed,” below.

Skin inspection

- Check your skin, or have your attendant or caregiver check your skin, a minimum of twice a day (morning and bedtime).
- Look for changes in skin color (redness or darkening), blisters, bruises, cracked, scraped or dry skin.
- Feel for hardness, swelling or warmth that may signal skin breakdown.
- Closely inspect areas that are at especially high risk for pressure sores because in some areas of the body the bones are close to the surface of the skin; the skin that is directly over bone is at highest risk. [For more information, read the fact sheet on “Areas at High Risk for Developing Pressure Sores.”]:
 - sacrum (lower back)
 - coccyx (tailbone)
 - heel of the foot
 - ischium (the base of the buttocks, “seat bones”)
 - trochanter (hip, from lying on side, something rubbing, or tight clothes)
 - elbow (from leaning on it)
 - knee (from spasms or side-lying with one knee on top of other)
 - ankle (from lying on side)
 - toes and bony areas of foot (from tight-fitting shoes)
 - back of the head
- Inspect areas of skin that are in contact with casts or braces twice daily.
- Use a mirror to inspect skin in hard-to-see areas. Train the person who helps you to carefully and regularly check your skin.
- Pay attention to fingernails and toenails: an ingrown toenail or cut along your nail bed may lead to a sore which can easily be infected.
- As soon as you notice a discolored area, stay off the area until it returns to normal skin color.
- If you suspect skin damage of any kind, read the fact sheet “Skin Care & Pressure Sores, Part 3: Recognizing and Treating Pressure Sores.”

Padding, positioning and turning in bed

- Use a regular schedule of turning at night. Depending on weight and skin tolerance, your turning schedule may vary from every 2 to every 6 hours. Ask your health care provider for advice about a turning schedule. When turning and moving in bed, lift rather than slide across sheets.
- Use pillows and foam pads (not folded towels or blankets) to protect bony areas. No two skin surfaces should rest against each other!
- Unless your doctor tells you to do it, avoid elevating the head of your bed, which can put too much pressure on your buttocks and lower back areas.
- For individuals at the highest risk for pressure sores, your health care provider may prescribe a special mattress, mattress overlay or bed for long-term use.

Keep skin clean and dry

- Bathe daily with mild soap and warm water and rinse and dry thoroughly. Pay particular attention to keeping the genital area and skin folds clean and dry.
- Immediately wash and dry skin and change clothing after any leakage of stool or urine.
- Avoid harsh soaps, skin agents with alcohol, and antibacterial or antimicrobial soaps. Do not use powders. Use a moisturizer that has been approved by your health care provider.

Get a proper seating evaluation at least every two years or sooner if your health or skin condition changes.

- Make sure you have the proper cushion for your wheelchair and your seating tolerance.
- Make sure you have the appropriate wheelchair, one that has been measured specifically for you and is compatible with your level of mobility, activities, work and associated equipment.
- The therapist doing the seating evaluation should place a pressure map above your cushion and under your buttocks to see where

your pressure-sensitive areas are. If at-risk areas on the pressure map are found, then the therapist may try a different cushion; alter the wheelchair seat, back or foot rest; or show you how to relieve pressure on the vulnerable areas by repositioning your body.

- Pressure mapping is an excellent way to visually demonstrate the effectiveness of weight shifts.
- If pressure mapping is unavailable, work with a seating professional and try several different cushions to see what works best for you.

Positioning and transferring

- Sit as erect as possible in your wheelchair. Slouching can damage skin.
- Perform safe transfers. Do not drag or scrape your bottom when moving in and out of your wheelchair.
- If you need help during transfers, make sure the person who is helping you is very well trained to assist.

Clothing, shoes

- Wear properly fitted clothing; avoid thick seams, rivets or bulky pockets and check for folds and wrinkles in areas of pressure.
- Shoes should be 1-2 sizes longer and wider than your pre-injury shoe size to allow for swelling of feet during the day.
- Use shoes with stiffer toes for protection when you bump into objects with your feet.
- Do not carry anything (comb, wallet, etc.) in your back pockets.

Hydration (fluid intake)

- Drink enough water every day to give your body the fluids it needs. Water intake may vary according to your bladder management routine—consult your health care provider for advice about how much water to drink.
- Avoid caffeinated drinks like coffee, tea and soft drinks, which are dehydrating and may trigger bladder spasms.

Nutrition

- Eat a balanced diet that includes adequate protein, fruits and vegetables (fresh if possible). Poor nutrition prevents the body tissue from rebuilding, staying healthy and fighting infection.
- If there is any question about your nutritional status you may ask your doctor to order a blood test to check your protein, albumen, prealbumen, lymphocyte or hemoglobin levels.
- If you have any conditions that may be affected by your nutrition (such as diabetes or hypertension), please consult with your health care provider who may recommend a consultation with a dietician.
- More information about nutrition and spinal cord injury:
 - “Nutritional Guidelines for Individuals with Spinal Cord Injury.” Northwest Regional Spinal Cord Injury System. (2006) <http://sci.washington.edu/info/forums/reports/nutrition.asp>.
 - “Weight Management Following SCI - SCI InfoSheet #8.” Discusses the role of nutrition in an overall weight management program. Spinal Cord Injury Information Network (2005). <http://www.spinalcord.uab.edu/show.asp?durki=21481>

Sun exposure

- Avoid getting sunburned. Some medicines make your skin more sensitive and may cause it to burn more easily. Use sunscreen and limit your time in the sun, or seek shade.

Equipment

- Use prescribed, individualized equipment when seated or lying down. Have a doctor or qualified professional recommend what specialized equipment (seat cushion, mattress, pillows) you need to protect your skin.
- Check wheelchair, mattress, cushions and transfer boards daily for problems. Maintain, at a minimum, the manufacturer’s recommendations for maintenance of all equipment.

Temperature

- Compared to before your injury, you are more susceptible to frostbite in cold weather due to changes in circulation and lack of sensation.
- You are also more susceptible to burns. Avoid contact with hot objects (metal pipes, fireplaces, heater in your home or car, hot water in the shower, microwaved dishes or food items you might want to place on your lap).

Circulation

- Quit smoking!
- Keep as active as possible.

Source

Our health information content is based on research evidence and/or professional consensus and has been reviewed and approved by an editorial team of experts from the SCI Model Systems.

Authorship

This brochure was developed by the SCI Dissemination Committee in collaboration with the University of Washington Model Systems Knowledge Translation Center. Portions of this document were adapted from materials produced by the SCI Model Systems.

The *Skin Care and Pressure Sores* series:

- Part 1: Causes and Risks of Pressure Sores
- Part 2: Preventing Pressure Sores
Supplements:
 - How to do Pressure Reliefs (Weight Shifts)
 - Building Skin Tolerance for Pressure
 - Areas of the Body at High Risk for Pressure Sores
- Part 3: Recognizing and Treating Pressure Sores
Supplements:
 - Stages of Pressure Sores: Illustrations



Spinal Cord Injury Model System
SCIMS | NIDRR
A NIDRR Funded Program

Skin Care & Pressure Sores

Part 2: Preventing Pressure Sores

Supplement: Areas at high risk of developing pressure sores



For more information, contact your nearest SCI Model System. For a list of SCI Model Systems go to: <http://www.msktc.org/scimodel-system-centers>

This publication was produced by the SCI Model Systems in collaboration with the University of Washington Model Systems Knowledge Translation Center with funding from the National Institute on Disability and Rehabilitation Research in the U.S. Department of Education, grant no. H133A060070.

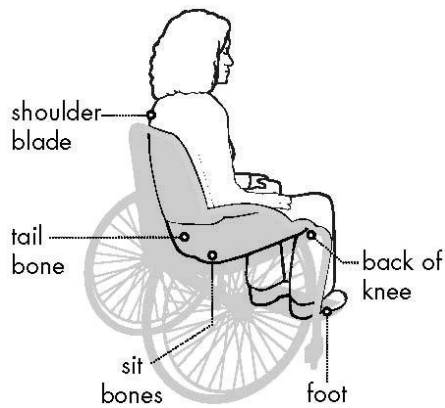

Areas where bones are close to the surface (called “bony prominences”) and areas that are under the most pressure are at greatest risk for developing pressure sores.

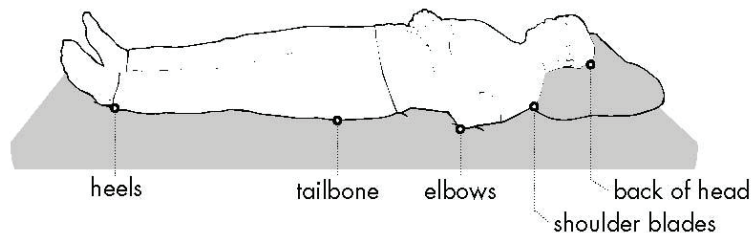

In bed, body parts can be padded with pillows or foam to keep bony prominences (areas where bones are close to the skin surface) free of pressure. Place a pillow between the knees while sleeping on your side to prevent

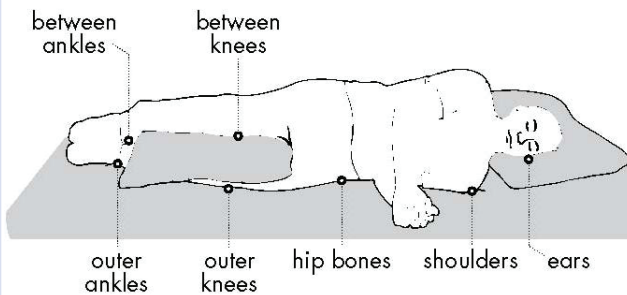

skin-to-skin contact and increase air circulation between your legs.

Illustrations from the Northwest Regional SCI System (2006).

Source

Our health information content is based on research evidence and/or professional consensus and has been reviewed and approved by an editorial team of experts from the SCI Model Systems.

Authorship

This brochure was developed by the SCI Model System Dissemination Committee in collaboration with the University of Washington Model Systems Knowledge Translation Center. Portions of this document were adapted from materials produced by the SCI Model Systems.

Skin Care & Pressure Sores

Part 2: Preventing Pressure Sores

Supplement: Building skin tolerance for pressure



For more information, contact your nearest SCI Model System. For a list of SCI Model Systems go to: <http://www.msctc.org/sci/model-system-centers>

This publication was produced by the SCI Model Systems in collaboration with the University of Washington Model Systems Knowledge Translation Center with funding from the National Institute on Disability and Rehabilitation Research in the U.S. Department of Education, grant no. H133A060070.

What is skin tolerance?

Skin tolerance is how much time your skin can stand to be under pressure before damage starts to occur. Each person's skin tolerance is different. Some people may need to relieve pressure very often, others may not have to do it as often, but they still need to do it!

Skin tolerance changes if you are sick, not eating well, have changes in posture or you change the surface you sit or lie on. Inspect your skin more frequently under these circumstances.

How do I know what my skin can tolerate?

When you were in the hospital, the staff worked with you daily to help you build skin tolerance and know what limits your skin can handle. Discuss skin tolerance with your physician or seating specialist if you have questions.

The increase in redness of your skin after applying pressure (the first sign of a pressure sore) and the amount of time it takes for the redness to fade will tell you what your skin can tolerate and whether to increase your time between pressure reliefs.

Remember, no matter how many hours you sit in a wheelchair, you need to move yourself every 15 to 30 minutes.

How do I know if I can increase sitting time or time in one position?

- Building up skin tolerance is a gradual process. You can build skin tolerance for any position, lying down or sitting, by following these steps:
- Lie in one position for the amount of time advised by your doctor.
- Look at your skin. Test if the pink areas of your skin turn white when touched.
- Stay off the area until the redness or pinkness clears completely.
- If redness or pinkness clears in 15-30 minutes, you may increase your time between pressure reliefs or turning by 30 minutes.
- If redness or pinkness does not clear in 15-30 minutes, do not increase your time between pressure reliefs or turning.

Source

Our health information content is based on research evidence and/or professional consensus and has been reviewed and approved by an editorial team of experts from the SCI Model Systems.

Authorship

This brochure was developed by the SCI Model System Dissemination Committee in collaboration with the University of Washington Model Systems Knowledge Translation Center. Portions of this document were adapted from materials produced by the SCI Model Systems.

Skin Care & Pressure Sores

Part 2: Preventing Pressure Sores

Supplement: How to do pressure reliefs (weight shifts)



For more information, contact your nearest SCI Model System. For a list of SCI Model Systems go to: <http://www.msktc.org/sci/model-system-centers>

This publication was produced by the SCI Model Systems in collaboration with the University of Washington Model Systems Knowledge Translation Center with funding from the National Institute on Disability and Rehabilitation Research in the U.S. Department of Education, grant no. H133A060070.

The pressure relief technique you use will depend on your level of injury, the type of wheelchair you use and how much movement and strength you have in your arms and shoulders.

Tilting or reclining

- If you are unable to perform independent pressure reliefs, you can use a power tilt wheelchair for regular pressure relief.
- Tilt, recline and elevating leg rests are features that can be used to change body position in a manner that provides pressure relief.
- It is very important that you receive training from your health care provider in how to use any of these features in order to make sure you are getting enough pressure relief. Improper use of these features can also lead to injury.
- Note that tilt and recline features provide the most pressure relief when used in combination. (RESNA, 2008)
- **Tilt systems** maintain the seat to back angle but change the angle orientation to the ground. Tilt angle of between 25 and 65 degrees has been shown to provide pressure relief, but 15 degrees or less does not provide adequate pressure relief. Figure 1 shows a 65 degree tilt.
- **Recline systems** (Figure 2) provide a change in seat-to-back angle while maintaining a constant seat angle with respect to the ground. The use of recline affects the vertical (downward) pressure and horizontal pressure on your skin and needs to be evaluated individually.
- **Elevating leg rests** allow change in the angle of legs and/or footrests in relation to the seat, extending the knee. This feature can help reduce pressure when using the recline feature.

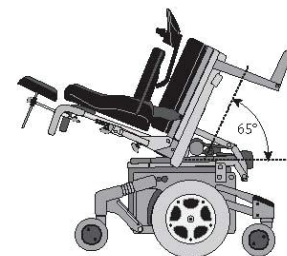

Figure 1: Tilt System



Figure 2: Recline System

Leaning from side to side

This technique relieves pressure over one buttock at a time.

1. **Lock your wheels**, and swing away one armrest from your wheelchair.



Figure 3



Figure 4

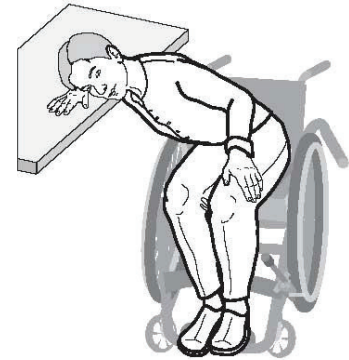

Figure 5

2. Hold onto the remaining armrest and lean your body to the opposite side, taking the weight off one buttock for 30-90 seconds (Figure 3). If you cannot grasp the armrest with your hand, you may be able to hook your wrist behind the wheelchair push handle or back rest (Figure 4).
3. To regain the upright position, you may need to use the wheelchair push handle or armrest for assistance. Some also find that pushing up on the push rims of the wheels helps in regaining upright position.
4. You may use a table or other stationary object to lean against for assistance (Figure 5). Just be sure the weight is completely off the opposite buttock, and hold the position for 30-90 seconds.
5. Repeat on the other side.

Leaning forward

This technique can be done independently or with assistance.

1. Move your wheelchair so that **the front casters are turned forward**, then **lock the wheels** of your wheelchair.
2. Bend forward and bring your chest to your knees (Figure 6). This lifts the weight of your bottom from the wheelchair. Stay in this position for 30-90 seconds.
3. Return your body to the upright position. There are several techniques to regain upright position depending on your equipment and the strength in your arms and trunk. You may:
 - Place your hand on your knees and push up.
 - Keep your hand on push handles and pull up.
 - Place your hand against the front of the armrest and push up.

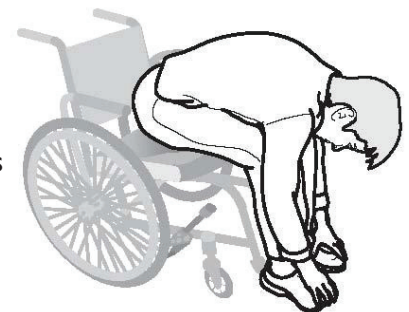

Figure 6

Independent push-ups

This technique can be used by individuals who can extend their elbows and lift their body weight (people with an injury at C7 and below). Grip your arm rests with your hands and lift up completely off your seat for 60 seconds. Since this method could harm the rotator cuff (part of the shoulder joint), it should only be used if you are unable to complete the other techniques.

Progression of Training

Early in your training, you may find that it is difficult to shift your weight away from the center of your chair. It may also be difficult for you to regain upright position after shifting your weight. You may try the following techniques.

- Position and lock your chair next to a stationary object. Perform the side lean as instructed above, but use the object to push up as you regain the upright position.
- Position and lock your chair in front of a table. Lean forward onto the table and use it to push back up.

Alternate Techniques

If you are looking for less obvious pressure relief techniques when you are out in the community, the following suggestions can be done without attracting attention.

- Cross one leg over the other and lean back to one side while holding your knee in position, lifting the weight off one buttock (Figure 7). Repeat using the other leg.
- Cross your leg by putting one ankle over the other knee and lean forward, lifting the weight off your buttock (Figure 8). Repeat using the other leg.
- Spend some time “fixing” your shoe laces, your feet, or the hem of your pants to achieve the same position as the forward lean technique (Figure 6).
- Lean against tables as you speak to friends.



Figure 7



Figure 8

References

Resna Position on the Application of Tilt, Recline and Elevating Legrests, Rehabilitation Engineering & Assistive Technology Society of North America. Arlington, VA. April 2008.

Source

Our health information content is based on research evidence and/or professional consensus and has been reviewed and approved by an editorial team of experts from the SCI Model Systems.

Authorship

This brochure was developed by the SCI Model System Dissemination Committee in collaboration with the University of Washington Model Systems Knowledge Translation Center. Portions of this document were adapted from materials produced by the SCI Model Systems.

Skin Care & Pressure Sores

Part 3: Recognizing and Treating Pressure Sores



For more information, contact your nearest SCI Model System. For a list of SCI Model Systems go to: <http://www.msktc.org/sci/model-system-centers>

This publication was produced by the SCI Model Systems in collaboration with the University of Washington Model Systems Knowledge Translation Center with funding from the National Institute on Disability and Rehabilitation Research in the U.S. Department of Education, grant no. H133A060070.

How can I tell if I have a pressure sore?

- **First signs.** One of the first signs of a possible skin sore is a reddened, discolored or darkened area (an African American's skin may look purple, bluish or shiny). It may feel hard and warm to the touch.
- **A pressure sore has begun** if you remove pressure from the reddened area for 10 to 30 minutes and the skin color does not return to normal after that time. **Stay off the area** and follow instructions under Stage 1, below. Find and correct the cause immediately.
- **Test your skin with the blanching test:** Press on the red, pink or darkened area with your finger. The area should go white; remove the pressure and the area should return to red, pink or darkened color within a few seconds, indicating good blood flow. If the area stays white, then blood flow has been impaired and damage has begun.
- **Dark skin** may not have visible blanching even when healthy, so it is important to look for other signs of damage like color changes or hardness compared to surrounding areas.
- **Warning:** What you see at the skin's surface is often the smallest part of the sore, and this can fool you into thinking you only have a little problem. But skin damage from pressure doesn't start at the skin surface. Pressure usually results from the blood vessels being squeezed between the skin surface and bone, so the muscles and the tissues under the skin near the bone suffer the greatest damage. Every pressure sore seen on the skin, no matter how small, should be regarded as serious because of the probable damage below the skin surface.

Stages of pressure sores

[Also see "Stages of Pressure Sores: Illustrations."]

STAGE 1

- **Signs:** Skin is not broken but is red or discolored or may show changes in hardness or temperature compared to surrounding areas. When you press on it, it stays red and does not lighten or turn white (blanch). The redness or change in color does not fade within 30 minutes after pressure is removed.
- **What to do:** Stay off the area and remove all pressure; keep the area clean and dry; eat adequate calories high in protein, vitamins (especially A and C) and minerals (especially iron and zinc); drink more water; find and remove the cause; inspect the area at least twice a day; call your health care provider if it has not gone away in 2-3 days.
- **Healing time:** A pressure sore at this stage can be reversed in about three days if all pressure is taken off the site.

STAGE 2

- **Signs:** The topmost layer of skin (epidermis) is broken, creating a shallow open sore. The second layer of skin (dermis) may also be broken. Drainage (pus) or fluid leakage may or may not be present.
- **What to do:** Get the pressure off, follow steps in Stage 1, and see your health care provider right away.
- **Healing time:** Three days to three weeks.

STAGE 3

- **Signs:** The wound extends through the dermis (second layer of skin) into the fatty subcutaneous (below the skin) tissue. Bone, tendon and muscle are not visible. **Look for signs of infection** (redness around the edge of the sore, pus, odor, fever, or greenish drainage from the sore) and possible necrosis (black, dead tissue).
- **What to do:** If you have not already done so, get the pressure off and see your health care provider right away. Wounds in this stage frequently need special wound care. You may also qualify for a special bed or pressure-relieving mattress that can be ordered by your health care provider.
- **Healing time:** One to four months.

STAGE 4

- **Signs:** The wound extends into the muscle and can extend as far down as the bone. Usually lots of dead tissue and drainage are present. **There is a high possibility of infection.**
- **What to do:** Always consult your health care provider right away. Surgery is frequently required for this type of wound.
- **Healing time:** Anywhere from three months to two years.

SUSPECTED DEEP TISSUE INJURY *

- Purple or maroon localized area of discolored intact skin or blood-filled blister due to damage of underlying soft tissue from pressure and/or shear. The area may be surrounded by tissue that is painful, firm, mushy, boggy, warmer or cooler as compared to nearby tissue.
- Deep tissue injury may be difficult to detect in individuals with dark skin tones. Progression may include a thin blister over a dark wound

bed. The wound may further evolve and become covered by thin eschar (scab). Progression may be rapid exposing additional layers of tissue even with optimal treatment.

UNSTAGEABLE *

- Full thickness tissue loss in which the base of the ulcer is covered by slough (dead tissue separated from living tissue) of yellow, tan, gray, green or brown color, and/or eschar (scab) of tan, brown or black color in the wound bed.

* From: Pressure Ulcer Stages Revised by National Pressure Ulcer Advisory Panel (2007). <<http://www.npuap.org>>.

Possible complications of pressure sores:

- **Can be life threatening.**
- Infection can spread to the blood, heart and bone.
- Amputations.
- Prolonged bed rest that can keep you out of work, school and social activities for months.
- Autonomic dysreflexia.
- Because you are less active when healing a pressure sore, you are at higher risk for respiratory problems or urinary tract infections (UTIs)
- Treatment can be very costly in lost wages or additional medical expenses.

Source

Our health information content is based on research evidence and/or professional consensus and has been reviewed and approved by an editorial team of experts from the SCI Model Systems.

Authorship

This brochure was developed by the SCI Dissemination Committee in collaboration with the University of Washington Model Systems Knowledge Translation Center. Portions of this document were adapted from materials produced by the SCI Model Systems.

The *Skin Care and Pressure Sores* series:

- Part 1: Causes and Risks of Pressure Sores
- Part 2: Preventing Pressure Sores
Supplements:
 - How to do Pressure Reliefs (Weight Shifts)
 - Building Skin Tolerance for Pressure
 - Areas of the Body at High Risk for Pressure Sores
- Part 3: Recognizing and Treating Pressure Sores
Supplements:
 - Stages of Pressure Sores: Illustrations

Skin Care & Pressure Sores

Part 3: Recognizing and Treating Pressure Sores

Supplement: Stages of Pressure Sores: Illustrations



For more information, contact your nearest SCI Model System. For a list of SCI Model Systems go to: <http://www.msktc.org/sci/model-system-centers>

This publication was produced by the SCI Model Systems in collaboration with the University of Washington Model Systems Knowledge Translation Center with funding from the National Institute on Disability and Rehabilitation Research in the U.S. Department of Education, grant no. H133A060070.

NORMAL SKIN

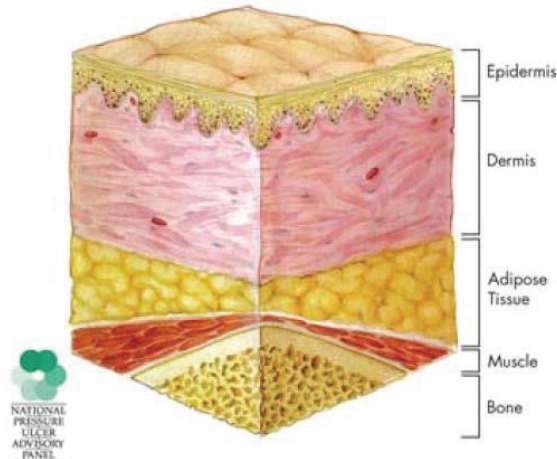

STAGE 1

Skin is not broken but is red or discolored. When you press it, it stays red and does not lighten or turn white (blanch). The redness or change in color does not fade within 30 minutes after pressure is removed.

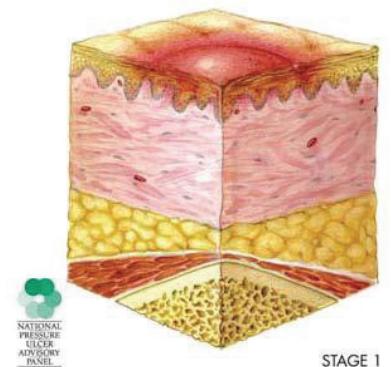

STAGE 1

STAGE 2

The topmost layer of skin (epidermis) is broken, creating a shallow open sore. The second layer of skin (dermis) may also be broken. Drainage may or may not be present.

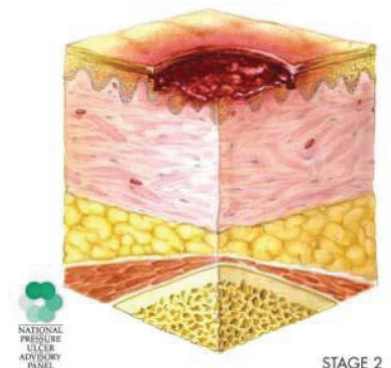

STAGE 2

STAGE 3

The wound extends through the dermis (second layer of skin) into the subcutaneous (below the skin) fat tissue. Bone, tendon and muscle are not visible. Look for signs of infection (pus, drainage) and possible necrosis (black, dead tissue).

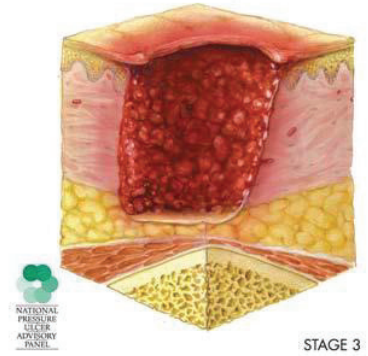

STAGE 4

The wound extends into the muscle and can extend as far down as the bone. Usually lots of dead tissue and drainage are present. There is a high possibility of infection.

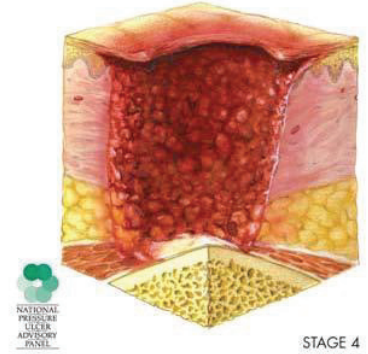

Illustrations are from the National Pressure Ulcer Advisory Panel (<http://www.npuap.org/>).

Source

Our health information content is based on research evidence and/or professional consensus and has been reviewed and approved by an editorial team of experts from the SCI Model Systems.

Authorship

This brochure was developed by the SCI Model System Dissemination Committee in collaboration with the University of Washington Model Systems Knowledge Translation Center. Portions of this document were adapted from materials produced by the SCI Model Systems.



Spinal Cord Injury Model System
SCIMS | NIDRR
A NIDRR Funded Program

Spasticity and Spinal Cord Injury



For more information, contact your nearest SCI Model System. For a list of SCI Model Systems go to: <http://www.msktc.org/sci/model-system-centers>

This publication was produced by the SCI Model Systems in collaboration with the University of Washington Model Systems Knowledge Translation Center with funding from the National Institute on Disability and Rehabilitation Research in the U.S. Department of Education, grant no. H133A060070.

What is spasticity?

Spasticity is the uncontrolled tightening or contracting of the muscles that is common in individuals with spinal cord injuries. About 65%–78% of the SCI population have some amount of spasticity, and it is more common in cervical (neck) than thoracic (chest) and lumbar (lower back) injuries.

Symptoms and severity of spasticity vary from person to person and can include:

- Sudden, involuntary flexing (bending) or extending (straightening) of a limb, or jerking of muscle groups such as in the trunk (chest, back, and abdomen), bladder, or rectum.
- Hyperactive (overactive) reflexes, such as a muscle spasm when you are lightly touched.
- Stiff or tight muscles at rest, so that it is difficult to relax or stretch your muscles.
- Muscle tightness during activity, making it difficult for you to control your movement.

What causes spasticity?

The nerves of the spinal cord and brain form a complex communication circuit that controls our body movements. Information on sensations or processes such as touch, movement or muscle stretch is sent up the spinal cord to the brain. In response, the brain interprets the signal and sends the necessary commands back down the spinal cord to tell your body how to react. The reaction of the body, such as jerking away from a hot object, is a reflex and happens quickly and automatically.

After a spinal cord injury, the normal flow of signals is disrupted, and the message does not reach the brain. Instead, the signals are sent back to the motor cells in the spinal cord and cause a reflex muscle spasm. This can result in a twitch, jerk or stiffening of the muscle.

Just about any touch, movement or irritation can trigger and sustain spasms.

Common triggers are:

- Stretching your muscles.
- Moving your arm or leg.
- Any irritation to the skin, such as rubbing, chafing, a rash, in-grown toenails, or anything that would normally be very hot or cold or cause pain.
- Pressure sores.
- A urinary tract infection or full bladder.

- Constipation or large hemorrhoids.
- Fracture or other injury to the muscles, tendons or bone below the level of spinal cord injury.
- Tight clothing, wraps or binders.

Spasticity can be irritating, inconvenient or even limit your ability to go through your day.

What are the benefits of spasticity in SCI?

Spasticity is not always harmful or bothersome and does not always need to be treated. Sometimes spasticity can help with functional activities such as standing or transferring. Spasticity that causes your fingers to bend can help you grip objects. Spasticity can also be a signal that you have a medical problem that you might not know about otherwise, such as a urinary tract infection, fracture, or pressure sore.

What problems are caused by spasticity?

- Spasticity can be painful.
- Spasticity can result in loss of range of motion in your joints (contractures).
- Severe spasms can make it difficult for you to drive or transfer safely, or to stay properly seated in your wheelchair.
- Spasticity in your chest muscles may make it difficult to take a deep breath.
- Strong spasms in the trunk or legs can cause you to fall out of your wheelchair when you change position, transfer, or ride over uneven surfaces.
- Repeated muscle spasms at night can cause you to sleep poorly and be tired during the day.
- Spasms can cause rubbing that leads to skin breakdown.
- Spasticity can make movement harder to control, so that activities such as feeding yourself may be more difficult.

Managing spasticity after SCI

First, practice healthy behaviors and good self-care that will help you avoid problems that can increase spasticity, such as urinary tract infections and skin breakdown. Check to see if any of the common triggers listed above may be causing the problem.

Physical treatments

The following treatments will help to maintain flexibility and therefore reduce spasticity and the risk for permanent joint contracture:

- Regular stretching (range-of-motion) exercises twice daily will help maintain flexibility and temporarily reduce muscle tightness.
- Weight-bearing or standing with support, such as using a standing frame or other supportive devices, will help stretch muscles.
- Splints, braces, or progressive casting into the desired position provides continuous muscle stretching that helps to maintain flexibility and a position that does not trigger a spasm.
- Careful use of hot or cold packs. When used in body areas that have partial sensation, check skin tolerance frequently as it may result in a burn if too hot and frostbite if too cold. Avoid the use of hot packs over areas without sensation.

Medications

When physical measures are not enough to control spasticity, medications may be needed.

▪ Oral medications

If spasticity involves large areas of your body, your doctor may prescribe one or more of the following medications:

- Baclofen
- Benzodiazepines (muscle relaxants) such as diazepam, clonazepam
- Dantrolene
- Tizanidine

The effectiveness of these medications varies with each person. Because these medications can have side effects such as fatigue or drowsiness, weakness, nausea, or sometimes low blood pressure, your provider needs to monitor you closely.

▪ Nerve or motor point blocks

If only part of your body has spasticity, anesthetic medications, alcohol, phenol or neurotoxins (such as strains of botulinum toxin) can be injected into the muscles that have spasticity. The medications rarely cause widespread side-effects. The benefits of the injections are only temporary, however, so injections must be repeated a few times a year. These injections can be used alone or in combination with oral spasticity medications.

Surgery

▪ Intrathecal medication therapy (also called a “pump” or “baclofen pump”)

Intrathecal drug therapy uses a surgically placed, battery-powered pump and an attached catheter to deliver medication directly into the spinal canal, around the spinal cord (called the “intrathecal” space). The most commonly used intrathecal drug for spasticity is baclofen. Intrathecal baclofen can be used in conjunction with the other treatments listed above. This treatment is generally not recommended until other treatments have been tried and failed to provide relief or if oral medications cause unacceptable side effects.

Advantages of intrathecal baclofen:

- The drug is delivered directly around the spinal cord, so lower doses of medication are needed.
- Fewer negative side effects because the drug does not enter the bloodstream.
- The amount and dosing schedule of drug throughout the day can be precisely set and adjusted by the health care provider to meet each individual patient’s needs.
- The pump can be stopped or removed, if necessary.

Disadvantages of intrathecal baclofen:

- You will need surgery to implant the pump and catheter system. Any surgery has risks, such as infection.
- The pump has a limited battery life and will need to be replaced about every 5-7 years.
- You will need to go to your provider periodically for pump refills (done by injecting baclofen through the skin into the pump reservoir).

Mechanical problems with the device may occur and could result in a baclofen overdose or underdose. For this reason, it is important for you to understand the risks, monitor yourself carefully, and get regular follow-up from your provider.

▪ Other Surgery

Other surgical treatments for spasticity are far less commonly performed because they are not reversible. These include cutting a section of the spinal cord (myelotomy) or nerve roots (rhizotomy), or lengthening and transposing a tendon. Your doctor will discuss these surgical options with you if necessary.

Which treatment is best for me?

Discuss your specific needs and treatment options with your health care provider or team. You may need to try different methods, medications, or combinations of treatments before you feel your spasticity is under control. Consider the following questions and discuss them with your provider:

- What are your goals for treatment of your spasticity?
- How important is it that the treatment can be reversed or stopped?
- What are the possible short-term and long-term side-effects of each treatment?
- Are there other health conditions that would influence the treatment choice?
- If you are considering intrathecal baclofen: Will you be able to follow the maintenance requirements? Do you have a good understanding of the possible risks and benefits?

Whatever treatment you choose, you will need to work closely with your treatment provider or team to get the best possible outcome.

What happens to spasticity over time?

In general, spasticity appears to become less bothersome over time. Possibly this happens because people learn to avoid things that trigger spasticity. Changes that naturally go on in the body as you age, such as a slowing down of nerve conduction, may also decrease spasticity. However, an unexplained, sudden or dramatic change in your spasticity level may sometimes signal a problem, so let your health care provider know immediately.

Source

Our health information content is based on research evidence whenever available and represents the consensus of expert opinion of the SCI Model System directors.

Authorship

Spasticity and Spinal Cord Injury was developed by Maria R. Reyes, MD and Anthony Chiodo, MD, in collaboration with the University of Washington Model Systems Knowledge Translation Center.

Portions of this document were adapted from materials developed by the University of Michigan and UAB Model Systems.

Disclaimer

This information is not meant to replace the advice from a medical professional. You should consult your health care provider regarding specific medical concerns or treatment.

Spinal Cord Injury and Gait Training



For more information, contact your nearest SCI Model System. For a list of SCI Model Systems go to:

<http://www.msctc.org/sci/model-system-centers>

This publication was produced by the SCI Model Systems in collaboration with the Model Systems Knowledge Translation Center at the University of Washington with funding from the National Institute on Disability and Rehabilitation Research in the U.S. Department of Education, grant no. H133A060070.

Difficulty walking is very common following a spinal cord injury (SCI). People with an “incomplete” SCI have more potential to regain walking than those with a “complete” SCI, but people with both types of SCI may have gait training included in their therapy plans.

Gait training is practicing walking (also called ambulation) with assistive devices and braces as needed. The following categories are used by health professionals to describe the kind of walking you are able to do.

- **Community:** You are able to walk at home and in the community.
- **Household:** You can walk within the home and use a wheelchair as the primary way to get around in the community.
- **Exercise:** You use a wheelchair in the community and at home, and you walk with assistance once or twice a day for exercise.
- **Non-ambulatory:** You only use a wheelchair for mobility. You may also walk while doing gait training with the therapist in the therapy gym only.

Why is gait training needed?

A spinal cord injury damages nerve cells and can prevent movement signals from the brain to the muscles. It can also disrupt the signals that do reach the muscles, making the muscles “jump” on their own. Therefore, a SCI can create weakness and spasticity in the feet, legs, hips, and trunk, as well as in the hands and arms. The injury can also damage and disrupt nerve signals for sensation (feeling) so that parts of the body are without sensation or have abnormal sensations, such as burning or tingling. Each of these problems can lead to difficulty walking.

Is gait training right for you?

A physical therapist (PT) or other clinician will determine if gait training is right for you by using a variety of tests. He/she will test your strength, sensation, ability to stand up, balance while standing, spasticity or stiffness, and range of motion at your hips, knees, ankles, and trunk. If you are able to take some steps, the clinician will watch you walk to look for safety issues.

The clinician may also provide you assistive devices and/or braces to give you better balance, protect your joints, and ensure your safety as you walk. He/ she may then test your walking speed, endurance, and balance with these devices and braces to keep track of your therapy progress. Gait training can require a lot of work and be a long process, so it is important for your PT or other clinician to tell you what you can expect.

Some people with SCI work on balance and other “pre-gait” activities many times a week for over 6 months before they start actual gait training (involving walking). Gait training may not be appropriate early in your recovery, but it may be at a later point when you are stronger and have better balance.

Gait training treatment options

Early Gait Training

You may take your first steps after the SCI using a variety of equipment including parallel bars, a pool, or a body-weight support device. A body-weight support device lifts part of your weight through a harness you wear as you try to take some steps. Some of these devices roll on the ground and some are placed over a treadmill. Your therapist, a therapy team, or a robotic device may help with your balance and stepping movements. It is very beneficial to be upright and moving as soon as your doctor says it is OK.

Later Gait Training

Depending on your SCI, your therapist may begin to work with you on the ground without a body-weight support device or parallel bars. You may also be given assistive devices and/or braces to improve your balance and help you walk safely. A device may be more or less appropriate depending on your strength and balance. It is helpful to experiment with different assistive devices and braces to find what is right for you.

Assistive devices may include:

- Special walkers that have safety straps at your hips and trunk
- A standard walker with no wheels on the legs
- A rolling walker (walker with 2 wheels on front legs), if your balance is a little better
- A rolling walker with forearm platforms, if you have weak arms
- A rollator walker (walker with 4 wheels and a basket), if you have good enough balance to walk in the community
- One or two forearm (or “Loftstrand”) crutches, if you have better strength and balance, but a weak grip

- One or two quad canes with four tips at the bottom, if you have pretty good strength and balance and at least a fair grip
- One or two straight canes with a single tip at the bottom, if you only need a little help with your balance and have a good grip.

If you are able to use crutches and canes, you will likely start with two, using one in each hand. Sometimes you will train with a crutch or cane in only one hand to be able to use your other hand to carry things, open doors, etc. However, you should be careful when using only one crutch or cane. Many people who use a device in only one hand tend to lean on it too much and develop a limp to that side. Using a device in each hand helps to keep your posture straight and your steps even.

Braces

Braces can have many benefits such as the following:

- Protecting weak joints and preventing knee hyperextension by keeping your joints in the proper alignment as you put weight on them during walking.
- Reducing the risk of falling by helping to keep your knee straight and your toes up as you take a step.
- Increasing your walking speed and how long you are able to walk.

Types of Braces

- Ankle-foot-orthosis (AFO)
- Knee-ankle-foot-orthosis (KAFO)
- Hip-knee-ankle-foot-orthosis (HKAFO)
- Floor reaction orthosis for people with knees that buckle
- Supra-malleolar orthosis (SMO) at just the ankle to keep you from “turning your ankle”

Braces may be made of plastic and metal, just plastic, or carbon fiber. They may be “off-the-shelf” pre-made braces, or they may be custom made by an orthotist to fit you. Some newer ankle-foot-orthosis designs, such as the lateral strut braces, try to fit more people with a more versatile and open pre-made shape.

It is recommended that you get evaluated by your therapist or orthotist to determine the best brace for you, especially if you cannot feel where the brace will go.

Always be sure you check your skin before you put the brace on and after you take it off, looking for reddened areas on your skin or open wounds. If the brace has caused a pressure sore, do not wear it again until your therapist or orthotist can modify it for you.

Body-weight support device

If you are eventually able to walk with assistive devices or braces, you may still continue gait training on a body-weight support device to help increase your speed and improve your balance and the timing, coordination, and symmetry of your steps. This is performed without using walking devices or braces. You will receive verbal instructions and manual assistance from your therapist and team. All levels of gait training activities can be practiced safely in the harness of these devices, because you cannot fall.

Transferring what you have practiced in the harness to the ground is very important. Assistive devices and braces may still be required to protect your joints and prevent you from falling while transferring to the ground.

Continued gait training with your therapist will hopefully improve your balance and strength so that you can rely less on devices or braces.

Will gait training be effective for you?

The ultimate goal of gait training is to be able to walk in any community environment without assistive devices or braces, but many people will still need one or the other, or both.

Every individual makes progress in therapy at their own pace. Some people may learn to walk well in a few months, and others may take years. Still others are unable to progress beyond just walking in therapy.

Safety

If you experience falls while walking with or without assistive devices, be sure to tell your health professional as you may need different walking supports and/or more training. People with SCI can have fragile bones due to lack of physical movement, so falling can cause broken bones. Preventing falls is a top priority during gait training and walking in the community.

Outcomes of Gait Training

The ability to walk after a spinal cord injury depends on many factors including your:

- level of injury
- severity of injury
- time since injury
- age
- level of fitness
- other injuries
- level of sensation
- other related problems such as spasticity and joint problems (contractures)
- level of pain

Therefore, it is difficult to predict if a person with SCI will regain walking abilities.

Looking at severity of injury as a factor, the following numbers show the percentage of people in a study who walked with some kind of assistive device and/or braces but no physical assistance from another person, at the time of discharge from inpatient rehabilitation. The ASIA Impairment Scale (AIS) classification level was made when patients were admitted to the hospital.

Proportion of people with SCI who walked at inpatient discharge with devices/braces and without physical assistance:

- ASIA A (motor and sensory complete): 6.4%
- ASIA B (motor complete, sensory incomplete): 23.5%

- ASIA C (motor and sensory incomplete, generally weaker legs): 51.4%
- ASIA D (motor and sensory incomplete, generally stronger legs): 88.9%

Those with the most severe, “complete” SCIs may experience that walking with their assistive devices and braces is very difficult and slow. They often decide to use a wheelchair to maneuver quickly and efficiently through their daily lives, and practice walking with devices and braces for exercise only. Regarding level of injury, those with a complete injury level below T11 have greater potential to walk in the community while using devices and braces.

People with incomplete SCIs have greater potential than those with complete SCIs to regain function and walking. Those with the “incomplete” injuries Brown-Séquard Syndrome (left or right half of the spinal cord is injured) or with Central Cord Syndrome (the arms are more affected than the legs) have the greatest potential to regain walking. People with SCI who have more accurate sensation also have a better chance of walking.

Resources

Atrice MB, Morrison SA, McDowell SL, Ackerman PM, Foy TA. Traumatic spinal cord injury. In: Umphred DA. *Neurological Rehabilitation*. 5th ed. St. Louis, MO: Mosby; 2006: 605-657.

Field-Foté E. *Spinal Cord Injury Rehabilitation (Contemporary Perspectives in Rehabilitation)*. Philadelphia, PA: F A Davis Co; 2009.

Sisto SA, Druin E, Macht Sliwinski MM. *Spinal Cord Injuries: Management and Rehabilitation*. St. Louis, MO: Mosby; 2008.

M Selzer, B Dobkin. *Spinal Cord Injury: A Guide for Patients and Families (American Academy of Neurology)*. New York, NY: Demos Health; 2008.

References

Gittler MS, McKinley WO, Stiens SA, Groah SL, Kirshblum SC. Spinal cord injury medicine. 3. Rehabilitation outcomes. *Arch Phys Med Rehabil*. 2002;83 Suppl 1: S65-71.

Morganti B, Scivoletto G, Ditunno P, Ditunno JF, Molinari M. Walking index for spinal cord injury (WISCI): criterion validation. *Spinal Cord*. 2005;43: 27-33.

Zörner B, Blanckenhorn WU, Dietz V, EM-SCI Study Group, Curt A. Clinical algorithm for improved predication of ambulation and patient stratification after incomplete spinal cord injury. *J Neurotrauma*. 2010;27:241-252.

Winchester P, Smith P, Foreman N, Mosby JM, Pacheco F, Querry R, Tansey K. A prediction model for determining over ground walking speed after locomotor training in persons with motor incomplete spinal cord injury. *J Spinal Cord Med*. 2009; 32: 63-71.

Disclaimer

This information is not meant to replace the advice from a medical professional. You should consult your health care provider regarding specific medical concerns or treatment.

Source

Our health information content is based on research evidence whenever available and represents the consensus of expert opinion of the SCI Model System directors.

Authorship

SCI & Gait Training was developed by Leslie VanHiel, BME, MSPT, CCRC., in collaboration with the Model Systems Knowledge Translation Center.

Getting the Right Wheelchair:

What the SCI Consumer Needs to Know



For more information, contact your nearest SCI Model System. For a list of SCI Model Systems go to: <http://www.msktc.org/scimodel-system-centers>

This publication was produced by the SCI Model Systems in collaboration with the University of Washington Model Systems Knowledge Translation Center with funding from the National Institute on Disability and Rehabilitation Research in the U.S. Department of Education, grant no. H133A060070.

Your wheelchair is an important part of your life, so you want to make sure you end up with the right wheelchair that fits your body, preferences, activities and lifestyle.

Wheelchair seating technology is a complex and rapidly changing industry, with new types of wheelchairs and components coming on the market all the time. The days of “one size fits all” are long gone. With all the different choices, how do you pick the right one? Many different factors must be considered when making the decision.

The Clinic

Selecting the right clinic is a critical first step. The clinic you select should have a process and the key players in place to assist you with making the right choice. You can call in advance to find out who is part of the team, if they have certification, and how long the process takes. It may be necessary for you to travel to get the best team to work with you on your chair. You would not hesitate to drive a long distance for the right surgeon; your wheelchair selection is equally important.

The Team

The right clinic will have a team of individuals to help with wheelchair selection, each of whom has different expertise.

- **You:** The most important member of the team is you, the wheelchair user. Even if this is your first wheelchair, your opinions and desires are essential in order to make the best selection.
- **Family members or caregivers:** Individuals you live with or who care for you will also be affected by the wheelchair selection and should provide input.
- **Rehabilitation professionals:**
 - **Rehabilitation medicine doctor** (called a **physiatrist**) who understands your overall health situation. The doctor is the one who writes the prescription needed for your insurance to pay for the wheelchair and has ultimate responsibility for determination of medical necessity.
 - **Occupational or physical therapist** who is experienced in wheelchair evaluation and training.
 - **Qualified wheelchair supplier** who works with the therapy and medical team to trial, order and maintain equipment.
 - **Certification:** Many occupational and physical therapists and wheelchair suppliers will have Assistive Technology Practitioner (ATP) certification from RESNA (Rehabilitation Engineering and Assistive Technol-

ogy Society of North America) indicating they have passed a national examination and credentials check in their specialty. If Medicare is the payer, they require the wheelchair vendor to have at least one ATP-credentialed specialist.

Medical and Physical Considerations

The team needs to consider many factors to ensure that you get the right wheelchair for your body, your health and your care needs.

- **Time since injury**
 - **Newly injured individuals:** If this is your first wheelchair, you will likely need more advice on the technology that will best suit your needs. In addition, you may continue to have physical changes or recovery over the next several months, in which case this first chair may only be temporary. As a result, the team may recommend a rental chair or more frequent follow-ups.
 - **Long-time injuries:** If you have been using a wheelchair for a long time and have developed new problems, such as weakness or pain, you may need to make changes to your current wheelchair seating system.
- **Age** affects endurance and strength and may be a deciding factor between a manual or power wheelchair.
- **Strength and range of motion** will determine whether or how much you can push your wheelchair, transfer in and out of your wheelchair, lift and fold your wheelchair, etc.
- **Height and weight** will affect what size wheelchair you will need.
- **Trunk stability:** The higher your level of injury, the more unstable you are likely to be, and this requires extra attention to seating and position to enhance stability.
- **Functional abilities:** Your level and completeness of spinal cord injury will affect how much function you have in your arms and hands and whether you will need a power or manual wheelchair.
- **Medical conditions or risks:** Conditions such as spasticity, previous pressure sores, or urinary

leakage can also affect wheelchair selection and should be discussed with your team.

Caregiver Considerations

It is important for the people who care for you to be able to work with your wheelchair, which may include pushing it occasionally or lifting, folding, fixing, cleaning or adjusting the wheelchair.

Environment and Lifestyle Considerations

Your wheelchair is a tool that enables you to do more of what you want in life.

- **Home:** Is your home carpeted? Are entrances to your home steep? Are there difficult surface conditions that a wheelchair might need to push over, such as gravel or grass? While you may make changes to your home to accommodate a chair, it is also possible that chairs exist that can help you when changes to the home environment are not possible or desired.
- **Work:** What will you be doing for work, and how does your wheelchair need to fit into that environment? For example, will your wheelchair fit under the conference room table where you meet twice a week?
- **Transportation:** Will you be driving your own vehicle? Van or car? Will you be taking public transportation? Will someone else be driving you around?
- **Leisure activities:** Will you spend time outdoors on grass or hiking on trails? Will the wheelchair also be used for sports?
- **Personal taste/preferences:** For example, some people may prefer a sportier-looking chair or a specific color (but note that something other than the standard color may cost more).

Financial Considerations

- **Insurance coverage:** This is often a major consideration when choosing a wheelchair and may limit your choices. However, it is best to choose the optimal chair first, then consider your financing.
- **Other financial resources:** Local resources to assist in purchasing your chair may be available

through organizations such as United Cerebral Palsy or the Multiple Sclerosis Society. Despite their names, these organizations often help people with any disability. Some individuals have fund-raisers through their church or temple.

Steps in the Process of Getting a Wheelchair

- 1. History and physical exam** by physician, OT, and/or PT, who will use this information to justify (to the insurance company) the wheelchair and seating system you need and to ensure that medical issues are properly addressed.
- 2. Test Drive:** You should always test drive the device. Ideally this will occur at the clinic during your visit and later during the home assessment. A good wheelchair clinic should have the ability to get devices for you to test drive during your visit.
- 3. Home assessment:** It is best to have a supplier or therapist assess your home to recommend appropriate equipment. Some insurance plans (including Medicare) require this step, and others do not.
- 4. Submission of prescription and documentation**
The clinical team will likely need to submit a Letter of Medical Necessity (LMN).
- 5. Delivery, final fitting and wheelchair driving skills training:** Ideally the wheelchair will be delivered to the clinic, where the team will make sure that the wheelchair that was ordered is, in fact, what was delivered. In addition, the chair will likely need to be adjusted for the best fit. Finally, the team will train you on how to use the chair properly to avoid injury.

Plan Ahead

It is important to plan for the possibility that your wheel chair will break down and need repairs. If possible, keep a spare wheelchair on hand. If not, have a plan in place to insure timely repair and the use of a loaner.

Pressure Mapping Technology

Pressure mapping technology is a way of measuring seating pressure and can help a clinician decide which cushion provides the best pres-

sure distribution for a particular individual. A pressure-mapping evaluation of a cushion and seating system can help make sure your skin is protected.

Resources

Choosing A Wheelchair: A Guide for Optimal Independence by Gary Karp (Cambridge, Mass: O'Reilly, 1998).

Also in the SCI Model Systems Consumer Information Series on Wheelchairs:

- *The Manual Wheelchair: What the SCI Consumer Needs to Know*
- *The Power Wheelchair: What the SCI Consumer Needs to Know*

Source

Our health information content is based on research evidence whenever available and represents the consensus of expert opinion of the SCI Model System directors.

Authorship

Getting the Right Wheelchair: What the SCI Consumer Needs to Know was developed by Michael L. Boninger, MD, in collaboration with the University of Washington Model Systems Knowledge Translation Center.

Disclaimer

This information is not meant to replace the advice from a medical professional. You should consult your health care provider regarding specific medical concerns or treatment.



Spinal Cord Injury Model System
SCIMS | NIDRR
A NIDRR Funded Program

The Manual Wheelchair

What the SCI Consumer Needs to Know



For more information, contact your nearest SCI Model System. For a list of SCI Model Systems go to:
<http://www.msctc.org/sci/model-system-centers>

This publication was produced by the SCI Model Systems in collaboration with the University of Washington Model Systems Knowledge Translation Center with funding from the National Institute on Disability and Rehabilitation Research in the U.S. Department of Education, grant no. H133A060070.

Introduction

The wheelchair is a complex piece of equipment that has been extensively engineered and studied. Most individuals with SCI become wheelchair experts because doing so increases their chances of getting a wheelchair that truly meets their needs. However, there are numerous options when considering a manual wheelchair, so it is critical to get help (see the SCI Model System Consumer Information guide *Getting the Right Wheelchair: What the SCI Consumer Needs to Know*). While it is not possible to teach you all there is to know in a single handout, this factsheet includes some of the most important information.

Why Choose a Manual Wheelchair?

If you have enough function to propel a manual wheelchair, it is probably the best form of mobility. Manual wheelchairs are easy to transport, need fewer repairs, and provide a form of exercise. However, they are not for everyone; you need to have the ability to propel. Most people with an injury level below C6 can propel a manual chair and some individuals with a C6 level can as well; this will be dependent on your weight, fitness, strength, level of pain, and the environment in which you need to push. While manual wheelchair propulsion can be a form of exercise, it can also lead to arm injuries from repetitive use. This risk makes it critical to get the right chair, to set it up correctly and to learn how to effectively propel.

Features and Components

Weight

Wheelchairs are generally classified by Medicare (which sets the industry standards) as *lightweight* (less than 34 lbs.) and *ultralight* (less than 30 lbs.). (These weights do not include footrests or armrests.)

Lightweight chairs are often not adjustable and are not recommended for SCI. Ultralight chairs are more expensive than the lightweight chairs, are highly adjustable, and incorporate many design features that improve mobility and comfort. Adjustability allows the wheelchair to be set up for optimal propulsion efficiency, which can reduce the risk of injury. It is harder to get insurance companies to pay for this type of wheelchair. Clinical practice guidelines recommend the lightest chair possible. Titanium and aluminum chairs can weigh under 20 lbs.

Frames

Frames may be folding or rigid. Rigid frames tend to perform better when maneuvering. Folding frames are often easier to transport, although many

rigid chairs can get to a very small size by removing the wheels and folding down the backrest.

Components

Many components (Figure 1) are important for wheelchair function. These components come in a variety of styles, and selection depends on your needs, preferences and lifestyle.

- **Footrests** support your feet and lower legs. They can be fixed, folding or swing-away and come in many different styles.
- **Armrests** are places to rest your arms when you're not moving. They can be wraparound, full-length or desk-length; fixed or height-adjustable; removable or flip-back. Fit is important because armrest position can alter the way you propel your wheelchair. Many individuals choose not to have armrests because they don't like the way they look or they get in the way of propulsion.
- **Wheel locks** act as parking brakes to stabilize your wheelchair when you transfer to other seats or want to remain in a particular spot. They may be push-to-lock or pull-to-lock, positioned low or high on the wheelchair, and retractable or not, depending on what the user finds easier. Wheel locks can get in the way during propulsion and add weight to the wheelchair. For this reason many individuals choose not to have wheel locks, relying on their hands to keep their chair still. Not having wheel locks can increase the risk of the chair moving during a transfer, however, which you should consider when making this decision.
- **Tires** are most commonly air-filled (pneumatic) and therefore lightweight. They also require maintenance and can puncture. If you maintain them, this is usually the best choice. Pneumatic tires may instead be filled with solid foam inserts; these won't puncture but are slightly heavier and don't perform as well. Solid tires are low-cost and no-maintenance, but make for an uncomfortable ride and are not usually recommended.

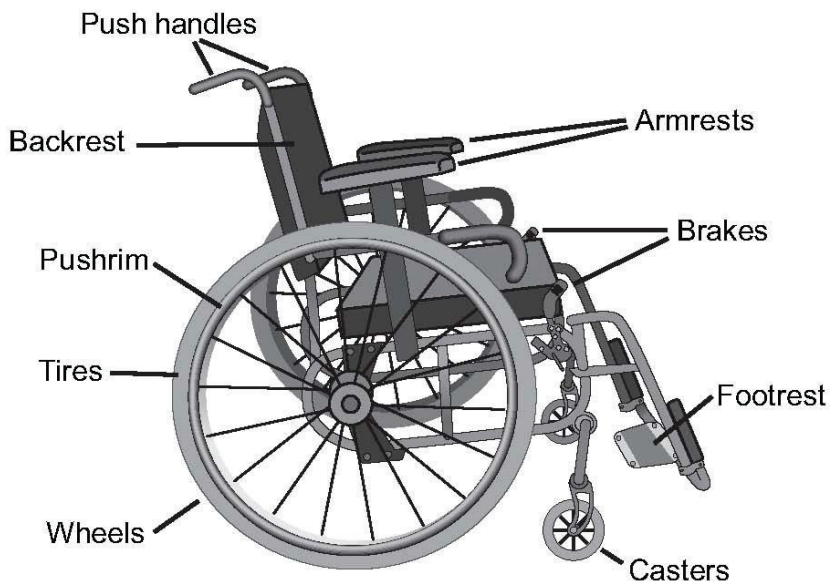

Figure 1. Wheelchair Components

- **Backrest:** Sling backrests are the most common, but provide little postural support. Adjustable tension backrests can provide more support and can be adjusted over time. Rigid backrests provide the best support, but may make it more difficult to collapse the chair. The weight and height of the backrest are important. In general, the lighter the better, with carbon fiber backrests being a nice option. If support is not needed, a lower backrest is better as it does not get in the way of pushing.
- **Cushions** come in a huge and ever-changing array of different types and materials and comprise a major topic unto itself. While pressure relief is an important consideration when selecting a cushion, you should also keep in mind that you want a firm base and a light-weight cushion. A firm base refers to feeling stable, not sliding on the cushion when reaching for an object or propelling your chair.
- **Pushrims:** There are a variety of pushrims with different friction coatings and shapes that may assist with propulsion and reduce the risk of injury to the hand.
- **Additional features** include anti-tippers, wheels and caster wheels of various styles, push handles and grade-aids (which keep the chair from rolling backward).

Set-up and Fit

Set-up and fit of your wheelchair is critical to good performance.

- **Seat height and width:** If the fit is too tight, it can cause pressure sores; too wide, and it may cause problems with stability, posture and fitting through doorways. The seat height should make it easy to access the pushrim as well as transfer surfaces. To test this, let your hands dangle at your side when sitting in the chair: your fingertips should extend just past the chair's axle.
- **Seat slope** is the difference between the front seat-to-floor height and the rear seat-to-floor height. It is common to have a slight seat slope (so buttocks are lower than your knees) to keep your body stable in your wheelchair.
- **Rear axle position** is important as it impacts how easy it is to push and tip your chair. In general you want the rear axle as far forward as possible (this will make it easier to push) without making the chair too easy to tip over backwards.
- **Camber** is the angle of the wheel with respect to the chair (Figure 2). A little camber is a good thing as it will protect your hands and increase your base of support. Too much camber will make it hard to fit through doorways.

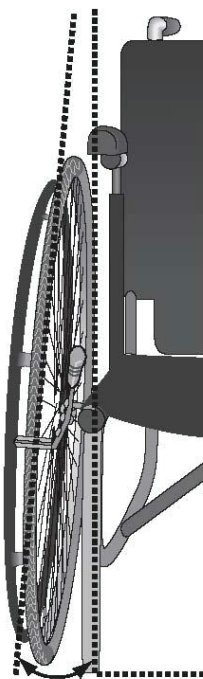

Figure 2.
Camber

Propulsion

Your therapist will train you on the best way to propel your wheelchair to be efficient and avoid injury. Long smooth strokes are better than short strokes, and the hand should drop below the push rim during the recovery (non-pushing) part of the stroke.

The Wheelie

Ask your physician for a referral to a therapist who can teach you how to “pop” and hold a wheelie. This skill can help you get through uneven terrain and over curbs. It can give you

greater awareness of your balance point, which may decrease your chances of tipping over. When performing a wheelie, if your front wheels are more than two or three inches off the ground, your rear axle is probably too far back and could be adjusted forward.

References

Boninger ML, Cooper RA, Fay B, Koontz A, *Musculoskeletal Pain and Overuse Injuries in Spinal Cord Medicine: Principles and Practices*, Demos Medical Publishing, NY, 2003.

Resources

ABLEDATA is a non-commercial information center for assistive technology, including wheelchairs. Go to www.abledata.com (select *Products*, then *Wheeled Mobility*) or call 800-227-0216.

Consortium for Spinal Cord Medicine, *Preservation of Upper Limb Function Following Spinal Cord Injury: What You Should Know* (Paralyzed Veterans of America, 2005).

Gary Karp, *Choosing A Wheelchair: A Guide for Optimal Independence* (Cambridge, Mass: O'Reilly, 1998).

Cooper RA, Olson J, Cooper RM, Manual Wheelchair Lingo, *Paraplegia News*, pp. 17-24, Vol. 63, No. 11, November 2009.

Also in the SCI Model Systems Consumer Information Series on Wheelchairs:

- *Getting the Right Wheelchair: What the SCI Consumer Needs to Know*
- *The Power Wheelchair: What the SCI Consumer Needs to Know*

Source

Our health information content is based on research evidence whenever available and represents the consensus of expert opinion of the SCI Model System directors.

Authorship

The Power Wheelchair: What the SCI Consumer Needs to Know was developed by Michael Boninger, MD, in collaboration with the University of Washington Model Systems Knowledge Translation Center.

Disclaimer

This information is not meant to replace the advice from a medical professional. You should consult your health care provider regarding specific medical concerns or treatment.



The Power Wheelchair

What the SCI Consumer Needs to Know



For more information, contact your nearest SCI Model System. For a list of SCI Model Systems go to:

<http://www.msktc.org/sci/model-system-centers>

This publication was produced by the SCI Model Systems in collaboration with the University of Washington Model Systems Knowledge Translation Center with funding from the National Institute on Disability and Rehabilitation Research in the U.S. Department of Education, grant no. H133A060070.

Introduction

The wheelchair is a complex piece of equipment that has been extensively engineered and studied. Most individuals with SCI become wheelchair experts because doing so increases their chances of getting a wheelchair that truly meets their needs. However, power wheelchairs are technologically advanced and have many components, so it is critical to get help when purchasing a new chair (see the SCI Model Systems Consumer Information guide *Getting the Right Wheelchair: What the SCI Consumer Needs to Know*). While it is not possible to teach you all there is to know in a single handout, this factsheet includes some of the most important information.

Why Choose a Power Wheelchair?

A power wheelchair is appropriate if you are unable to propel a manual wheelchair or if you need to reduce the strain on your shoulders and arms so you can continue to perform transfers safely. The choice of power chair will depend on many factors, including the kind of surface conditions the chair will be driven over, the need to negotiate thresholds and curbs, and clearance widths in your usual environment.

Power Wheelchair Components

The Base

The power wheelchair base is the lower portion of a power wheelchair that houses the motors, batteries, drive wheels, casters and electronics to which a seating system is attached. It is classified according to drive wheel location relative to the system's center of gravity.

Rear-Wheel Drive

The drive wheels are behind the user's center of gravity, and the casters are in the front. It has predictable drive characteristics and stability but can be difficult to maneuver in tight places because of its larger turning radius.

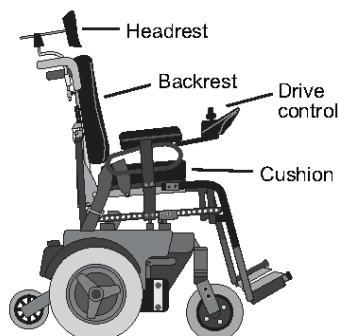

Figure 1. Rear-wheel drive power wheelchair

Front-Wheel Drive

The drive wheels are in front of the user's center of gravity, and the rear wheels are casters. This setup tends to be quite stable and provides a tight turning radius. However, it may have a tendency to fishtail and be difficult to drive in a straight line, especially when traveling fast on uneven surfaces.



Figure 2. Front-wheel drive power wheelchair with recline capability.

Midwheel Drive

The drive wheels are directly below the user's center of gravity. It has a smaller turning radius, making it more effective for indoor mobility, but not as good outdoors.

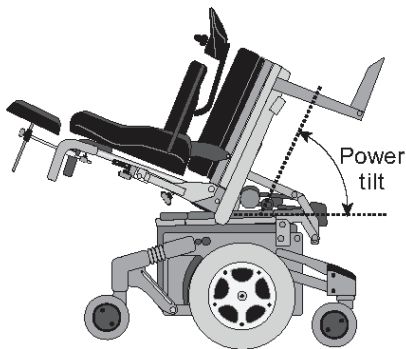

Figure 3. Midwheel drive power wheelchair with tilt-in-space capability.

Controls

The device used to control a power wheelchair is called an *access device* or *drive control*. It can also be used with environmental control systems and computer access. These controls are usually programmable and can be operated using various kinds of joysticks or switches (such as sip-and-puff).

Seating and Positioning

Seating and positioning are a critical part of your wheelchair and have an important role in your comfort, function, safety and health. Your seating system should be prescribed and designed specific to your medical, functional and personal preference needs, including protecting your skin from too much pressure.

Seating Systems

Seating systems fall into three general categories: off-the-shelf, modular and custom. In general, custom seating is only needed when musculoskeletal deformities are present such as scoliosis, or after a flap surgery for a pressure sore. The basic components of the seating system are the cushion and backrest.

Cushions and Backrests

Cushions and backrests are made out of a variety of materials, including contoured foam, air-filled bladders, combinations of air and foam, and gels. They vary in how well they address pressure distribution, postural stability, airflow, insulation or conduction of heat. Choice of style and material will depend on your individual needs and activities.

If all the needed features cannot be found in one cushion, trade-offs are necessary. Unlike with manual wheelchairs, the weight of the cushion and back support is generally not a consideration.

Research evidence suggests that a properly fitted pressure-reducing cushion, in contrast to a low-cost foam cushion, reduces the chances of getting a pressure sore.

Recline and Tilt-in-Space

Recline and tilt-in-space technologies relieve pressure, manage posture, provide comfort and help with personal care activities.

Recline (Figure 2), which changes the angle between the seat and backrest, helps to stretch hip flexors and makes attending to catheters, toileting and transfers more convenient for caregivers.

The addition of tilt-in-space (Figure 3), which tilts the seat and backrest together, keeps the hip and

knee angles constant when tilting back. This reduces the possibility of shear when in the recline position.

People who cannot independently shift weight or transfer should have a tilt-in-space and recline system on their wheelchair.

Seat Elevation & Standing Chairs

Power wheelchairs can also have elevating seats or mechanisms that stand the user upright while in the chair. Elevating seats can help with transfers, as it is easier to transfer downhill. In addition, elevating seats and standing chairs can make it easier and more functional to perform activities that are above shoulder height when sitting. Because performing activities above shoulder height puts you at risk of injuring your arms, recent guidelines recommend that all individuals with SCI who use power wheelchairs and have good arm function be provided with seat elevation.

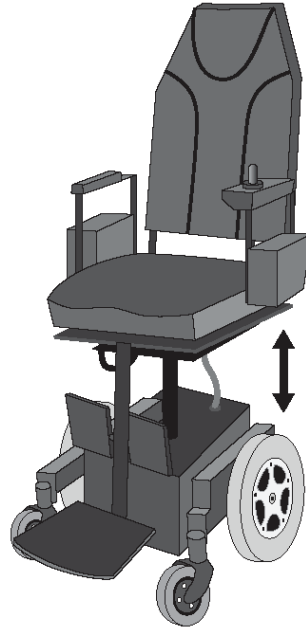

Figure 4. Power-elevating seat.

Power-Assisted Wheelchairs

Power-assisted wheelchairs are essentially manual wheelchairs with a motor that provides propulsion assistance when desired. This allows a user to propel the wheelchair more quickly and easily, and helps with obstacles such as steep ramps.

For individuals with shoulder pain or tetraplegia (quadriplegia), this can be a good compromise between a manual and power wheelchair.

Power-assisted wheelchairs are bulkier and less maneuverable than manual chairs, but they are less bulky, easier to transport and more maneuverable than power wheelchairs.

References

Boninger ML, Cooper RA, Fay B, Koontz A, *Musculoskeletal Pain and Overuse Injuries in Spinal Cord Medicine: Principles and Practices*, Demos Medical Publishing, NY, 2003.

Resources

- ABLEDATA is a non-commercial information center for assistive technology, including wheelchairs. Go to www.abledata.com (select *Products*, then *Wheeled Mobility*) or call 800-227-0216.
- Consortium for Spinal Cord Medicine, *Preservation of Upper Limb Function Following Spinal Cord Injury: What You Should Know* (Paralyzed Veterans of America, 2005).
- *Choosing A Wheelchair: A Guide for Optimal Independence* by Gary Karp (Cambridge, Mass: O'Reilly, 1998).

Also in the SCI Model Systems Consumer Information Series on Wheelchairs:

- *Getting the Right Wheelchair: What the SCI Consumer Needs to Know*
- *The Manual Wheelchair: What the SCI Consumer Needs to Know*

Source

Our health information content is based on research evidence whenever available and represents the consensus of expert opinion of the SCI Model System directors.

Authorship

The Power Wheelchair: What the SCI Consumer Needs to Know was developed by Michael Boninger, MD, in collaboration with the University of Washington Model Systems Knowledge Translation Center.

Disclaimer

This information is not meant to replace the advice from a medical professional. You should consult your health care provider regarding specific medical concerns or treatment.



Spinal Cord Injury Model System
SCIMS | NIDRR
 A NIDRR Funded Program

Volume 2: Factsheets Developed 2012–2024

A Guide to Inpatient Rehabilitation Services for People With Spinal Cord Injury

August 2023

<https://msktc.org/sci/factsheets>

SCI

This factsheet includes information about choosing an inpatient medical rehabilitation facility after an SCI.

What You Need to Know Before Choosing an Inpatient Rehabilitation Center



After a spinal cord injury (SCI), people need rehabilitation (rehab) to help them reach the highest level of functional independence. Many health care facilities offer rehab programs, but a limited number have expertise and experience in SCI rehab care. Choosing a facility that specializes in SCI rehab will help people with SCI to achieve their best outcomes.

After SCI, you are first treated at an acute care hospital. The acute care hospital staff may not know about specialty SCI rehab programs or the needs of people with SCI. You can get rehab in a **variety of settings**, with **varying levels of intensity and expertise**. Not all settings can manage the complex needs of people with SCI. This guide provides information to help you choose a facility that is right for you or your family member.

It is important for you and your family member to be active in making all decisions related to your care, including choosing a rehab center. Insurance coverage may affect your choices. Other factors to consider:

- Whether the rehab center has special expertise in SCI
- How close you would be to home and your family and friends. (This is important, but carefully review the expertise of local rehab programs. It may be worth having rehab further from home if the program has special expertise in SCI.)
- Whether housing is available. (A few SCI rehab programs offer housing for family members.)
- Whether you would have the opportunity to participate in inpatient rehab with others who are also adjusting to SCI. This may help you learn new skills and adapt to your SCI.



The Model Systems Knowledge Translation Center works with Spinal Cord Injury Model System centers to provide free research-based rehabilitation resources for people living with spinal cord injury (See <https://msktc.org/sci> for more information).

Inpatient Rehab Services

Why is specialized SCI inpatient rehabilitation important?



People with SCI have unique medical and rehab needs that are best met when you receive care provided by a specialized team of clinicians with experience in SCI rehab. Your rehab will be provided by a team that is made up of different rehabilitation specialists (such as physical, occupational, and speech therapists). Each specialist has their own focus. They work together with you toward the best possible outcomes and help you get the most from any muscle function you get back.

What SCI Rehab Services Should I Expect?

Rehab is team-based care that addresses changes in function due to SCI. You will work to maximize your physical function and independence as you learn new ways to do some activities of daily living. Your rehab team will manage your medical needs. They will also educate you about your SCI and how to prevent secondary conditions. Rehab also includes mental health services to help you adjust to changes after SCI.

Your rehab team will work with you to come up with achievable, short-term goals to work on during your stay. These goals will include a realistic idea of what you should be able to do with the function you have after SCI. These goals may change over time if you regain more function. Your rehab team will work with you to tailor your rehab to your specific needs.

Specialists who may be involved in your inpatient rehab include the following:

- **Physicians:** The physician leads your treatment team and manages your medical care. Often, the physician who leads the team is a physiatrist (fiz-EYE-ah-trist), which is a physician who specializes in rehabilitation. The physician who directs your care must have expertise and experience in treating people with SCI. Some physicians complete an accredited fellowship training program in SCI medicine. In this program, they focus on care for patients with SCI. Board certification in SCI medicine is recommended by both the Academy of Spinal Cord Injury Professionals and the American Spinal Injury Association. The physician plays an important role in the care of people with SCI and management of secondary conditions throughout their lives. 
- **Rehab nurses** educate patients about bowel and bladder management and how to prevent complications, such as pressure injuries (pressure sores). They also educate patients about any medicines they take. Rehab nurses reinforce the treatments and techniques you learn during therapy sessions. Some registered nurses have a rehab certification.
- **Physical therapists (PTs) and occupational therapists (OTs)** work together to help you regain your strength and stamina and learn new ways to complete daily activities. These activities might include eating, bathing, getting dressed, transferring from one surface to another (like from a bed to a wheelchair), using a wheelchair or walking. They help you learn how to use devices, durable medical equipment (DME), and assistive technology to maximize your physical mobility. OTs and PTs also work together to recommend modifications for home, school, or work to maximize your functional ability in those spaces. 
- **Recreation therapists** provide [adaptive sports and recreation opportunities](#) to help improve your health and well-being. They also help you reconnect with your community.
- **Psychologists** help you and your family work on issues associated with your emotional reaction to the SCI, including adaptation, behavioral and mental health as well as health management issues. They can also help to identify problems with learning and memory and work with patients and their families with managing these issues both in the inpatient setting and after discharge.
- **Case managers** work with you to review and update your discharge plan. They help coordinate appointments, services and supplies after discharge. With other members of your rehab team, they help you understand your health care benefits and help you to navigate insurance issues as they come up. Insurance companies may have their own case managers who are separate from hospital-based case managers. Case managers may be nurses, social workers or other healthcare professionals.

Other specialists who may be part of your care at an inpatient rehab program include:



- **Dietitians** can help address your nutritional needs. They can make sure that your body is getting all the nutrients it needs to promote healing and maintain skin integrity, improve bowel function, and maintain a healthy weight.
- **Respiratory therapists** assess, prevent and treat problems with breathing, under the direction of doctors. They will help to maximize your breathing capacity and, if applicable, manage your ventilator. See Table 1 for more information about ventilators.
- **Urologists** are physicians who specialize in issues that affect the urinary tract. A urology assessment and bladder management are key parts of your medical care after SCI. Urologists may be able to provide a urology assessment and explain your options for bladder management, sexuality, and fertility. The SCI rehab program should have access to a urologist with SCI expertise who can consult on your bladder management needs.
- **Speech-language pathologists (SLPs)** treat issues with swallowing or speaking after SCI. They also recommend technology to improve your communication if your speech is affected. SLPs have expertise related to swallowing assessments and can recommend foods and drinks that you can safely eat and drink.
- **Other physicians with specialties related to SCI.** These may include specialists dealing with bladder management, sexuality and fertility (urologist for men & ob/gyn for women), bone or joint injuries (orthopedic surgeons), surgeons who operate on the spinal cord (neurosurgeon).



Many rehabilitation programs offer other services to help people with SCI get back to their communities and do the things that are important to them. Some of these services include:

- **Outpatient medical care.** Some SCI rehab facilities offer outpatient medical care services for people with SCI across the lifespan. Physiatrists with SCI expertise treat secondary conditions that occur after SCI, such as spasticity, bladder and bowel management issues, and more.
- **Assistive technology.** These are items that are used by people with disabilities to increase, maintain, or improve their functions. Such technology may be low or high tech and can increase independence and help people control their environments. Examples of low-tech assistive technology solutions include pen holders, mouth sticks, and adapted utensils. High-tech assistive technology options include voice recognition software and customized power wheelchairs. At some rehab centers, specially trained therapists educate patients and family members about the latest assistive technology devices.
- **Wheelchair seating clinics.** Many SCI rehab facilities offer high-quality wheelchair seating clinics. These clinics help each patient find the best wheelchair and seating components to be mobile and prevent complications.
- **Vocational rehabilitation services.** These programs offer services to help people continue with their education or work. They help people identify career interests and skills, get education and training, find and apply for jobs, and organize accommodations at work.
- **Adaptive fitness, wellness, sports, and recreation programs.** Some rehab facilities offer adaptive fitness, wellness, sports, and recreation programs. These may be inpatient or outpatient services.
- **Peer support.** High-quality rehab programs often provide peer support services. Peer mentors who live with SCI share their experiences to help you adapt to the daily experience of living with SCI. Some rehab programs also offer peer support groups for people with SCI and their family members.
- **Sexual health.** Rehabilitation experts can help address sexual function needs.



How to Find an Appropriate Inpatient Rehabilitation Facility

You may receive inpatient rehab services in a freestanding rehab hospital or a rehab unit within a larger medical center. Before you leave the hospital, you should know what type of rehab center you or your family member are moving to because this affects your ability to receive the services described above. There are two major types of facilities that provide specialized inpatient rehab:



Inpatient Rehabilitation Facilities (IRFs)

IRFs provide intensive rehabilitation services for people who have limitations that affect their ability to perform activities of daily living. Such activities include bathing, dressing, eating, using the toilet, and walking. To be eligible for admission to an IRF, you need to meet the following criteria:

- Limitation in activities of daily living
- Your medical condition is stable, and in general, you can take part in at least 3 hours of therapy, 5 days per week (or 15 hours of therapy over 7 days).
- You must take part in two or more therapies, one of which must be occupational therapy or physical therapy.
- Your condition needs to be supervised by a rehab doctor.

You are expected to make some measurable and reasonable improvements in function during your rehab program. These improvements could include increased function or being able to adapt to your injury by finding new ways to do important activities. Admission to an IRF should not be denied solely because you may not be expected to return to a prior level of functioning.



SCI-Specialized Long Term Acute Care Hospitals (LTACHs)

LTACHs manage medically complex problems, such as respiratory issues that need ventilator management or severe pressure injuries (pressure sores or bedsores). Patients in LTACHs typically need longer hospital stays and often come directly from an intensive care unit. LTACHs may also offer respiratory, speech, physical, or occupational therapies, but there are no daily therapy requirements.

While there are a few LTACHs that offer specialized SCI rehab, most LTACHs do not offer specialized SCI rehab and may provide fewer than 3 hours of therapy per day. If you are being advised to go to an LTACH, it is very important to make sure that the LTACH you will go to has specialized SCI expertise and will provide therapy time that is comparable to or exceeds what you would receive in an IRF. To determine this, look for signs that the LTACH has special expertise in SCI, such as a SCI Model Systems designation and/or a CARF accreditation in an SCI Program of Care (see below).

Other Health Setting: Subacute Rehab Facilities, such as Skilled Nursing Facilities (SNFs)

There are many SNFs in the United States, but they rarely specialize in SCI rehab services. There are no daily therapy requirements in SNFs. It is important to ask the facility about their experience with treating patients with SCI; what rehab therapy, physician, and nursing services you can expect; and if they offer any specialty programs.



LTACHs and/or SNFs often serve as a bridge to or from IRFs (between an acute hospital and an IRF or between an IRF and home). A temporary stay in an LTACH might be needed if you have a medical issue (such as a fracture or skin sore) that needs time to improve before you would be able to participate fully in rehab. Admission to an LTACH or an SNF may also affect your ability to transfer to other types of settings. Ask your medical team about the reasons why an LTACH stay is being recommended. If the recommended LTACH does not have a specialized SCI rehabilitation program (as described above), speak with the team to make sure you will have the opportunity to transition later to another specialized SCI inpatient rehab program to reach your goals.

LTACHs and SNFs are not required to provide therapy on a daily basis. If you are being encouraged to go to an LTACH or SNF, do your research to make sure they have specialized certification in providing SCI rehab and will provide the therapy you need.

To help you find an appropriate rehab setting look for special designations or accreditations

Examples include:

- **SCI Model System Centers.** These centers provide comprehensive specialty services from the time of injury through rehab and reentry into community life. These centers also take part in SCI research. Currently there are [18 SCI Model System Centers](https://msktc.org/sci/model-system-centers) (<https://msktc.org/sci/model-system-centers>) in the United States.
- **CARF International (formerly the Commission on Accreditation of Rehabilitation Facilities).** CARF accredits rehab programs that meet specific standards of care. This includes general inpatient rehab programs that meet CARF standards. CARF also offers specialty accreditation for SCI rehab programs. The CARF directory lists CARF-approved SCI programs. Please see their special note providing guidance for finding SCI programs. SCI-accredited programs meet high standards and provide services across the life span. The CARF directory also includes pediatric rehab programs. The CARF website can be found at: <http://carf.org/providerSearch.aspx>.



Special Rehab Considerations

A few special considerations may help you to choose an appropriate rehab facility (see Table 1). It's important to consider your support system and your designated advocates, who can act on your behalf as you decide about moving to a different facility.

Table 1. Special Rehab Considerations

Population	Special Rehab Considerations
Children	<ul style="list-style-type: none"> • Some rehab facilities have pediatric or adolescent units. Some children's hospitals have rehab units. Check how many children with SCI any potential rehab facility treats each year. • Rehab programs should provide services that consider the child's growth and development. • The rehab team should include a pediatric physiatrist. • Parents or guardians of children with SCI should be equal partners in the rehab and education processes.



Population	Special Rehab Considerations
Ventilator users	<ul style="list-style-type: none"> • If you need ventilator services, please ensure that the program you are considering has those services. Ask how many patients with SCI they treat each year and if they have specific programs or protocols for SCI ventilator management. Again, ask your SCI medical team about your overall care plan. • Ask your SCI medical team if you are a candidate for more advanced interventions such as a diaphragm pacing system (DPS) or phrenic nerve pacing system. A DPS is a battery-powered device that uses electricity to directly cause the diaphragm muscle (the major muscle used in breathing) to contract. A phrenic nerve pacing system uses electricity to stimulate the phrenic nerve, the nerve that travels from the spinal cord to the diaphragm muscle. Either may provide part- or full-time respiratory support in place of a ventilator. • If you can't find an SCI rehab facility that cares for ventilator users in your state, reach out to an SCI organization for help finding such a facility (see Additional Resources section below).
Seniors	<ul style="list-style-type: none"> • Older individuals with SCI should be considered for admission to an inpatient rehab hospital. The rehab team may include a geriatrician—that is, a doctor who specializes in the health and care of older individuals.
Uninsured	<ul style="list-style-type: none"> • If you don't have insurance, work with your case manager to determine your insurance options. (See "Where to Go for Help with Insurance and Other Issues" in the Additional Resources section below).

Additional Information

If you can't find an SCI rehab facility, reach out to an SCI organization for help. These include [United Spinal Association](https://unitedspinal.org/) (<https://unitedspinal.org/>) or the [Christopher & Dana Reeve Foundation](https://www.christopherreeve.org/) (<https://www.christopherreeve.org/>).

Several guidelines suggest questions that you can ask of rehab facilities that you're considering (see the Additional Resources section below) to help you learn about their experience with SCI care.

Discharge From Inpatient Rehab

Discharge planning often begins when you are admitted to inpatient rehab. Such planning includes a review by members of your rehab team of your discharge location and the physical accessibility of the location.

Preparing for discharge can help reduce anxiety. Your hospital case manager or discharge planner will help you and your family prepare for discharge and identify resources in your community (e.g., finances, home care, transportation, and community service organizations) that can help you function well in your community. This often includes information about government services such as Supplemental Security Income (SSI), Social Security Disability Insurance (SSDI), Medicaid, Medicare, and other disability benefits. Your local Center for Independent Living (CIL) can help you learn about benefits, programs, and services for people with disabilities in your geographic region. CILs are private, nonprofit corporations that provide services to people with disabilities to support community living and independence.



You will be ready for discharge from inpatient rehab when you are medically stable and no longer need close supervision by a doctor. The range of a length of stay in inpatient rehab is typically 2-5 weeks. Length of time in rehab will vary based on the neurological level of your injury, personal circumstances, and many other factors. With input from your clinicians, you may decide to advocate for more time in inpatient rehab. At discharge, you will have learned about your health condition, how to manage and prevent secondary conditions, and how to operate medical equipment and assistive technology. You may have met the inpatient rehab goals developed by



you and your team; however, for most people, rehab continues after discharge in an outpatient clinic or home setting.

Where to Go for Help With Insurance for Your Inpatient Rehab Needs

Under the Patient Protection and Affordable Care Act (ACA; see References), you have the right to appeal decisions made by health insurance plans. The ACA's Patient's Bill of Rights details a set of patient protections that apply to health coverage. To learn about your rights, visit:

<https://www.cms.gov/CCIIO/Resources/Fact-Sheets-and-FAQs/aca-new-patients-bill-of-rights>.

Regardless of where you live or the type of insurance you have, the following guidance may help:

- **You have the right to know why a claim or coverage for your inpatient rehab needs was denied.** You have the right to file an appeal with the insurance company. If your case is urgent, your insurance company must speed up the process.
- **Insurers must provide a description of available internal appeals** and external review processes. This includes how to start an appeal.
- **When you need health coverage for out-of-network providers or facilities,** you need to explain that no facilities within the insurer's network have the needed training or expertise to treat your condition. Your doctor may need to provide a letter of medical necessity to explain this to the insurance company.
- If you can't work things through an internal appeal, **you have the right to take your appeal to an independent third party for review**—that is, you can engage, through your provider, in an Administrative Law Judge process. There are also protection and advocacy agencies across the country who can help you with other access issues. The Administration for Community Living (ACL) has information about state protection and advocacy systems (P&As). [Click here to find your P&A agency \(https://acl.gov/programs/aging-and-disability-networks/state-protection-advocacy-systems\)](https://acl.gov/programs/aging-and-disability-networks/state-protection-advocacy-systems).
- **Many states offer services to help manage health insurance denials** through a Department of Insurance or [Consumer Assistance Program \(https://www.cms.gov/CCIIO/Resources/Consumer-Assistance-Grants\)](https://www.cms.gov/CCIIO/Resources/Consumer-Assistance-Grants).
- If you are uninsured, see the "Uninsured" section of Table 1.

You can also reach out to your state legislature and ask for help. If you apply for Medicaid, work with constituent services at your state senator's or state representative's office to help speed up your application process: <https://www.congress.gov/state-legislature-websites>. For questions or to get insurance, visit [HealthCare.gov](https://www.healthcare.gov) or call 1-800-318-2596.

Additional Resources

- Consumer Guidelines (American Spinal Injury Association): <https://asia-spinalinjury.org/wp-content/uploads/2018/11/Consumer-Guidelines-v.-03082019.pdf>
- CARF International: Find a Provider (Note: Use the [advanced search for SCI rehabilitation programs](http://carf.org/providerSearch.aspx)): <http://carf.org/providerSearch.aspx>
- Guidelines for Selecting a Rehabilitation Facility (United Spinal Association): <https://askus-resource-center.unitedspinal.org/index.php?pg=kb.page&id=1717>
- Engaging With Insurers: Appealing a Denial (Patient Advocate Foundation): <https://www.patientadvocate.org/wp-content/uploads/Navigating-the-insurance-appeals-guide-pages-1.pdf>



- Find Your Protection and Advocacy Agency (Administration for Community Living): <https://acl.gov/programs/aging-and-disability-networks/state-protection-advocacy-systems>
- A Patient's Guide to Navigating the Insurance Appeals Process (Patient Advocate Foundation): <https://www.patientadvocate.org/wp-content/uploads/Navigating-the-insurance-appeals-guide-pages.pdf>
- 6 Strategies to Navigate Your Insurance Provider's Approvals Process (*New Mobility*, United Spinal Association): <https://newmobility.com/6-strategies-to-navigate-your-insurance-providers-approvals-process/>
- Affordable Care Act, Patient's Bill of Rights: <https://www.cms.gov/CCIIO/Resources/Fact-Sheets-and-FAQs/aca-new-patients-bill-of-rights>
- Living With Spinal Cord Injury - Model Systems Knowledge Translation Center: <https://msktc.org/sci>
- Medicare Benefit Policy Manual, Chapter 8—Coverage of Extended Care (SNF) Services Under Hospital Insurance: <https://www.cms.gov/Regulations-and-Guidance/Guidance/Manuals/Downloads/bp102c08pdf>

Consumer Organizations

- Directory of Centers for Independent Living (CILs): <https://www.ilru.org/projects/cil-net/cil-center-and-association-directory> and <https://www.ilru.org/projects/silc-net/silc-directory>
- Christopher & Dana Reeve Foundation: <https://www.christopherreeve.org/>
- Paralyzed Veterans of America: <https://pva.org/about-us/mission-statement/>
- United Spinal Association: <https://unitedspinal.org/>
- United Spinal Association: Spinal Cord Help Desk: <https://askus-resource-center.unitedspinal.org/index.php>

References

American Spinal Injury Association. *Consumer guidelines*. <https://asia-spinalinjury.org/wp-content/uploads/2018/11/Consumer-Guidelines-v.-03082019.pdf>



Camicia, M., Black, T., Farrell, J., Waites, K., Wirt, S., & Lutz, B. (2014). The essential role of the rehabilitation nurse in facilitating care transitions: A white paper by the Association of Rehabilitation Nurses. *Rehabilitation Nursing Journal*, 39(1), 3–15.

Center for Medicare Advocacy. (2013, May 30). *Frequently asked questions (FAQs) regarding the Jimmo v. Sebelius "Improvement Standard" settlement*. <https://medicareadvocacy.org/jimmo-v-sebelius-the-improvement-standard-case-faqs/>

Centers for Medicare & Medicaid Services. (2021, August 6). Chapter 1—Inpatient hospital services covered under part A: Section 110.2.2—Intensive level of rehabilitation services, Rev. 10892. In *Medicare benefit policy manual* (CMS Publication No. 100-02). U.S. Department of Health and Human Services. <https://www.cms.gov/regulations-and-guidance/guidance/manuals/downloads/bp102c01.pdf>

Centers for Medicare & Medicaid Services. (2021, August 6). Chapter 8: Coverage of extended care (SNF) services under hospital insurance. In *Medicare benefit policy manual* (CMS Publication No. 100-02). U.S. Department of Health and Human Services. <https://www.cms.gov/regulations-and-guidance/guidance/manuals/downloads/bp102c08pdf.pdf>



Emerich, L., Parsons, K. C., & Stein, A. (2012). Competent care for persons with spinal cord injury and dysfunction in acute inpatient rehabilitation. *Topics in Spinal Cord Injury Rehabilitation*, 18(2), 149–166.

Greenwald, B. D. (2021). *Traumatic brain injury and acute inpatient rehabilitation*. Model Systems Knowledge Translation Center (MSKTC). <https://msktc.org/tbi/factsheets/traumatic-brain-injury-and-acute-inpatient-rehabilitation>

Klebine, P., Smitherman, O., Gernenz, L., & Baldessari, J. (2020). *Understanding spinal cord injury: Part 2—Recovery and rehabilitation*. Model Systems Knowledge Translation Center (MSKTC). https://msktc.org/sci/factsheets/Understanding_SCI_Part_2

National Spinal Cord Injury Statistical Center. (2022). *Traumatic spinal cord injury facts and figures at a glance*. <https://msktc.org/sites/default/files/SCI-Facts-Figs-2022-Eng-508.pdf>

National Conference of State Legislatures. (2011, February). *Right to health insurance appeals process*. <https://www.ncsl.org/documents/health/HRHealthInsurApp.pdf>

Patient Advocate Foundation. *A patient's guide to navigating the insurance appeals process*. <https://www.patientadvocate.org/wp-content/uploads/Navigating-the-insurance-appeals-guide-pages.pdf>

Patient Protection and Affordable Care Act of 2010, Public Law 111-148, 124 Stat 1119 (2010).

Authorship

A Guide to Inpatient Rehabilitation Services for People With Spinal Cord Injury was developed by Jane Wierbicky, RN, Alexandra Bennewith, MPA, Anne Deutsch, PhD, Jeanne M. Zanca, PhD and members of United Spinal Association's Maximizing Rehabilitation Outcomes Special Interest Group, in collaboration with the Model Systems Knowledge Translation Center.

Source: The content in this factsheet is based on research and/or professional consensus. This content has been reviewed and approved by experts from the Spinal Cord Injury Model Systems (SCIMS), funded by the National Institute on Disability, Independent Living, and Rehabilitation Research (NIDILRR), and United Spinal Association. The content of the factsheet has also been reviewed by individuals with SCI and/or their family members.

Disclaimer: This information is not meant to replace the advice of a medical professional. You should consult your health care provider regarding specific medical concerns or treatment. The contents of this factsheet were developed under grants from the National Institute on Disability, Independent Living, and Rehabilitation Research (NIDILRR grant numbers 90SI5019 and 90DPKT0009). NIDILRR is a Center within the Administration for Community Living (ACL), U.S. Department of Health and Human Services (HHS). The contents of this factsheet do not necessarily represent the policy of NIDILRR, ACL, HHS, and you should not assume endorsement by the federal government.

Recommended citation: Wierbicky, J., Bennewith, A., Deutsch, A, Zanca, J. M., & Maximizing Rehabilitation Outcomes Special Interest Group. (2023, March). *A guide to inpatient rehabilitation services for people with spinal cord injury*. Model Systems Knowledge Translation Center (MSKTC). <https://msktc.org/sci/factsheets/guide-inpatient-rehabilitation-services-people-spinal-cord-injury>

Copyright © 2023 Model Systems Knowledge Translation Center (MSKTC). May be reproduced and distributed freely with appropriate attribution. Prior permission must be obtained for inclusion in fee-based materials.



Adaptive Sports and Recreation

December 2016

www.msctc.org/sci/factsheets

SCI Fact Sheet

This fact sheet explains the important role that adaptive sports and recreation can play after a spinal cord injury (SCI). It also describes different types of sports equipment and points out some health problems to watch for as you participate in sports activities.

Introduction

If you have an SCI, adaptive sports and recreation may be key to your lifelong wellness. These activities may also help you to engage with your community. Many options are available:

- ◆ Outdoor recreation activities (for example, adaptive kayaking, fishing, or snow skiing)
- ◆ Performing arts (for example, adaptive dance group)
- ◆ Individual sports (for example, wheelchair racing or hand cycling)
- ◆ Team or competitive sports (for example, wheelchair basketball, wheelchair tennis, quad rugby, or sled hockey)

Even if you have never taken part in sports before, you can find an adaptive activity that is right for you!



Importance of Adaptive Sports and Recreation

An SCI does not have to keep you from being active. Adaptive sports and recreation are good for your health. Without such activity, you may be at higher risk for physical and mental health problems, such as obesity, heart disease, and depression. You may also feel left out if you do not engage in enjoyable activities. Others may assume that you cannot be active just because of your injury.

Adaptive sports and recreation can help you get past these challenges. People with SCI who are involved in adaptive sports and recreation in the community are more likely to

- ◆ maintain a positive mood and prevent depression;
- ◆ feel more included and empowered in their communities;
- ◆ connect with positive mentors and peers with SCI; and
- ◆ hold a steady job.

But most of all, adaptive sports and recreation give you a chance to do fun activities with your family and friends.



The Spinal Cord Injury Model System is sponsored by the National Institute of Disability, Independent Living, and Rehabilitation Research, U.S. Department of Health and Human Services' Administration for Community Living. (See <http://www.msctc.org/sci/model-system-centers> for more information).

How To Get Involved in Adaptive Sports and Recreation

You can get involved in adaptive sports and recreation! Here are some tips to make it easier:

1. Think about your goals for participating in adaptive sports and recreation. Goals will be different for everyone. Here are some examples:
 - ◆ To do something with your family and friends that everyone will enjoy
 - ◆ To make friends by joining a sports team
 - ◆ To become physically fit and improve your health
 - ◆ To live an active life and enjoy the outdoors
 - ◆ To experience the thrill of competing



Keep your goals realistic and attainable. Ultimately, the goal of adaptive sports and recreation is to have fun and get out there!

2. Think about a location that is best for you to get involved in adaptive sports and recreation. You should consider your level of mobility, options for transportation, and how far you want to travel. Also think about whether you want to participate individually, on a team, or with family and friends.
3. Next, check out local resources. It may help to learn about all the options in your area so you can decide which one is best for you. Please see the section called “Adaptive Sports and Recreation Resources” for ideas.

Finally, try it out! Remember, it often takes time to learn a new skill. This may be true whether you are getting involved in adaptive sports and recreation for the first time or returning to sports after an SCI. If you don't like the activity you chose or don't feel successful at first, don't give up. You may find your activity more fun and fulfilling once you gain more skill and feel part of the adaptive sports community.



Importance of Mentorship

Having a mentor may help you get started in a new activity, such as sports and recreation. Whatever sport you choose, there are likely other people with SCI who have tried and succeeded in that sport! A mentor can “show you the ropes” and help you to work on any challenges. If you can't find a mentor in your area, you could check out a magazine or blog that focuses on adaptive sports. The section below on “Adaptive Sports and Recreation Resources” lists some options.

Types of Adaptive Sports Participation

You can choose from many types of adaptive sports and recreation. You may just be looking for fun, or you may want to compete. Here are some options to explore:

1. Community-based and nonprofit organizations may offer programs at no or low cost.
2. Every state has a parks and recreation association. Some focus on adaptive outdoor recreation. Examples include fishing, hunting, water skiing, or canoeing/kayaking.
3. Public schools must offer physical education and school-based sports to every student. Contact your local school district to find out about adaptive sports programs.
4. Many colleges and universities have adaptive sports programs. Examples include wheelchair basketball or track and field. Scholarships may be available to top athletes. Advocates are trying to get the National Collegiate Athletic Association (or NCAA) to sanction adaptive sports.
5. Paralympic sports highlight the skills of athletes with disabilities. People with SCI at all levels of function have the opportunity to compete.



Adaptive Sports and Recreation Resources

Sometimes just knowing where to find the tools you need to succeed may help you get involved in adaptive sports and recreation. Here are a few tips.

Organizations

1. Disabled Sports USA (DSUSA): DSUSA is a large membership organization with chapters across the United States. DSUSA leads a variety of adaptive sports programs for people with different types of disabilities, including SCI.
<http://www.disabledsportsusa.org>
2. U.S. Paralympics Sports Clubs: Paralympics Sports Clubs offer entry-level competitive adaptive sports to athletes of all ability levels.
<http://findaclub.usparalympics.org>
3. BlazeSports America: BlazeSports is based in Atlanta, GA, and provides adaptive sports and recreation programs regionally and internationally. Their goal is to make sure that youth and adults with disabilities have the same recreation opportunities as others.
<http://www.blazesports.org>
4. Adaptive Sports, USA: ASUSA is also a membership organization focused on providing adaptive sports opportunities for youth with disabilities, including SCI.
<http://www.adaptivesportsusa.org>
5. Rehabilitation Hospitals: Many rehabilitation hospitals support adaptive sports and recreation programs. Be sure to check out rehabilitation hospitals in your region or state to see if they have a sports program.

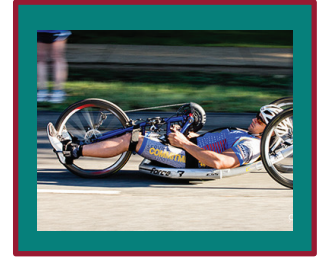

Magazines and Web Sites

1. *Sports 'N Spokes*: This magazine covers recent and upcoming events in adaptive sports and recreation.
<http://pvamag.com/sns/>
2. *Mpower Sports and Recreation*: This website highlights interesting stories about adaptive sports and recreation.
<http://mpower-sports.com/category/home/>

Equipment

Some local and national organizations, such as the ones listed here, help qualified applicants get sports equipment such as a sports wheelchair. It is important to try out and identify the equipment that works best for you before purchasing it.

1. Challenged Athletes Foundation: The Challenged Athletes Foundation provides grants for sports equipment to individuals with various types of disabilities. You can learn more at www.challengedathletes.org.
2. Kelly Brush Foundation: The Kelly Brush Foundation's goal is to break down the financial barrier to living an active lifestyle for individuals with SCI. You can learn more at <http://kellybrushfoundation.org>.

How Do Competitive Adaptive Sports Work?

Adaptive sports and recreation are activities that anyone can do, regardless of their level of physical ability. This includes people with SCI. This section provides information regarding how competitive adaptive sports are organized.



Types

In general, there are two types of adaptive sports:

1. Sports adapted to meet the needs of people with disabilities. For example:
 - a. Wheelchair basketball
 - ◆ Wheelchair basketball is played on a regulation basketball court using similar rules, with a few differences. For example, if a player pushes his/her sports wheelchair more than twice before dribbling, a “travel” foul is called.
 - b. Wheelchair tennis
 - ◆ Wheelchair tennis is played on a regulation tennis court using similar rules, with a few differences. For example, the “two-bounce rule” allows up to two bounces of the ball before a player must hit a return.
2. Sports created especially to be played by people with disabilities. For example:
 - a. Quad rugby
 - ◆ Quad rugby is a competitive team sport specifically designed for tetraplegic athletes.



As you can see, there are plenty of sport and recreation opportunities for people with SCI.

Classification

In competitive sports, people with disabilities can be placed in “classes” that match their functioning ability. This system was set up so athletes only compete with other people in a similar class. This way, the competition is fair and the best athlete wins, not the athlete with the most physical function.

In team sports, athletes are assigned a class, or “point” value, based on their physical function. Players with higher physical function are assigned higher point values. A team is then made up of several athletes whose total points cannot exceed a certain threshold. This ensures that the team includes people of all ability levels.

More information on classification can be found here: http://www.paralympic.org/sites/default/files/document/120716152047682_classificationguide_2.pdf

Sports Wheelchairs 101

Not everyone who has an SCI uses a wheelchair. For those who do, finding the right sports wheelchair can be tough, financially and otherwise. Almost every sport has its own type of chair. There are racing chairs, basketball chairs, tennis chairs, adaptive skis, and more. The two most common types of sports wheelchairs are rigid/custom fit or adjustable. If you know that you are going to be playing just one sport, you may want a custom chair. If you are new to a sport or plan to play multiple sports, an adjustable chair may be best.

Often, purchasing your own sports wheelchair is a step to take only after you become experienced in a sport. Many adaptive sports programs have chairs that you can borrow or rent simply to try it out. If you do decide to purchase a sports wheelchair, you will need to work with a manufacturer to select the chair that’s right for you. You should be fit for your chair by someone familiar with the sport you will be playing and the chair you want to purchase.

Here are a few examples (and there are many more):

Racing Chair



Basketball Chair



Rugby Chair

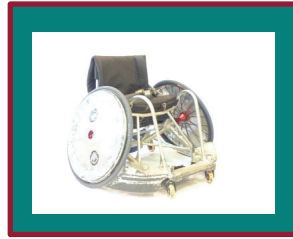

Tennis Chair



Sports Injury Prevention

Overall, for most people the health benefits of sports participation outweigh the risks. That said, it is important to be aware of how to prevent sports injuries. Injury risk varies depending on what sport you are playing, however here are some things to keep in mind:

- For wheelchair users, the area most affected by injury is the upper extremity, particularly the shoulder. If you begin to experience shoulder pain or other symptoms while participating in adaptive sports, be sure to tell your therapist or physician.
- All people with SCI who are participating in sports should implement a basic shoulder injury prevention program. For more information on how this can be developed, a resource is "Life on Wheels" from the National Center on Health, Physical Activity and Disability (NCHPAD): <http://www.nchpad.org/1200/5830/Life-on-Wheels>.
- For more information on injury prevention, please see the section on "Overuse injuries" in the factsheet titled [Exercise After SCI](http://www.msctc.org/sci/factsheets/Exercise_after_SCI) (http://www.msctc.org/sci/factsheets/Exercise_after_SCI).

Be Aware of Other Potential Health Problems

Adaptive sports and recreation should be fun and safe. But problems and injuries can occur, for example:

- ◆ Skin breakdown
- ◆ Difficulties with regulating body temperature
- ◆ Orthostatic hypotension
- ◆ Autonomic dysreflexia
- ◆ Broken bones

For information on these problems and how to prevent them, see the factsheet titled [Exercise After SCI](http://www.msctc.org/sci/factsheets/Exercise_after_SCI) (http://www.msctc.org/sci/factsheets/Exercise_after_SCI).

Authorship

Adaptive Sports and Recreation was developed by Cheri Blauwet, M.D., and Jayne Donovan, M.D., in collaboration with the National Center on Health, Physical Activity and Disability (NCHPAD) and the Model Systems Knowledge Translation Center. Credit for these images goes to Lakeshore Foundation and NCHPAD.

Source: Content is based on research and/or professional consensus. Editorial experts from the Spinal Cord Injury Model Systems reviewed and approved this content.

Disclaimer: The content of this factsheet does not replace the advice of a medical professional. You should consult a health care provider about specific medical concerns or treatment. This fact sheet was developed under a grant from the National Institute on Disability, Independent Living, and Rehabilitation Research (NIDILRR grant number 90DP0082). This content may not represent the policy of the U.S. Department of Health and Human Services. The federal government may not endorse this content.

Copyright © 2016 Model Systems Knowledge Translation Center (MSKTC). You can freely reproduce and distribute this content. Include proper attribution. But you must get permission before using this content in fee-based products.



Adjusting to Life After Spinal Cord Injury

June 2022

<https://msktc.org/sci/factsheets>

SCI Factsheet

It is important that rehabilitation is your main focus in the early weeks and months after injury. You can learn more about expectations for recovery, your role in rehabilitation, and find other suggestions to guide your recovery in “Understanding Spinal Cord Injury: Part 2—Recovery and Rehabilitation” at www.msktc.org/sci/factsheets/UnderstandingSCI

The Model Systems Knowledge Translation Center works with Spinal Cord Injury Model System (SCIMS) centers to provide free research-based rehabilitation resources for people living with spinal cord injury (see <https://msktc.org/sci> for more information). This factsheet has been approved by experts from the SCIMS centers.

What is adjustment?

Adjustment is how you adapt to or become used to changes in your life. A few examples of exciting changes in life are starting a new job, getting married, and having children. Losing a job, getting divorced, and losing a loved one are examples of changes that can be challenging.

Experiencing a spinal cord injury (SCI) is without doubt a new and challenging situation. SCI affects almost every aspect of your life when it happens, and it can be hard to put your life back in order and adjust to living with SCI. This initial adjustment period may be hard, but most people adjust well in time. Then, they continue to adjust to ongoing changes in life similar to those that everyone experiences.

What is it like when you first go home after SCI?

Going home is a major step in adjusting to life after SCI. It can be exciting to get back to the comforts of home. It can also be scary if you are unsure of what to expect once you get there.

Like most life-changing events, it takes time to adjust to a new “normal” after SCI. For example, you were probably used to a daily routine before your injury. You may have gotten up each morning to go to school or work, taken care of your children, or had regular household chores. Whatever the routine was, the day seemed normal because you had some idea of what to expect.

People who are newly injured adjust to a “new normal.” They often say it feels like they are doing things for the first time as they learn how to do activities differently. That feeling usually fades as they work through problems and learn how best to manage daily routines.

- You usually begin learning how to manage your self-care and daily activities during inpatient rehabilitation.
- Chances are you will have outpatient rehabilitation for a while after inpatient rehabilitation. Your strength and stamina usually improves. Your ability to do daily activities usually improves. The time you spend out of bed and up in your wheelchair usually increases. You may first depend on medical equipment, such as a hospital bed or assistive devices but not need them later.
- Over time, you may change the way you manage things at home. For example, you may have showered or did your bowel program at night during rehabilitation. You might find that doing these activities in the morning better fits your daily routine.



How do people adjust to SCI?

People have different expectations for life after SCI. It may be feeling happy. It may be preventing stress, depression, or anxiety. It may be doing meaningful and enjoyable activities. It may be any or all these things or something else, but most people adjust by setting and meeting their own expectations for life after SCI.



- Your personality and the way that you adjust to changes in your life do not usually change after SCI. This means you will likely adjust after SCI in your own way and in your own timeframe.
- You may feel “different” in your body in the early weeks and months after SCI. This feeling usually fades as you become comfortable with your self-image, learn to manage self-care, gain a better understanding of your body, and come to realize you are still the same person.
- You may re-think some of your personal values and what you find important in your life. For example, you may focus your attention more on your relationships with family and friends than you did before your SCI.

Adjusting Well

There is no one way to adjust to life after SCI. However, research offers some insight into what adjusting well looks like. People who adjust well:

- Do not experience depression, or if they are depressed soon after SCI, they feel better again within a few weeks.
- Have an effective coping strategy.
 - Have a “fighting spirit” and use every means necessary to overcome challenges and setbacks.
 - View their SCI as a challenge and see the potential for personal growth to make their life better.
 - Accept that their SCI has happened and decide to live with it.
- Are resilient, meaning they bounce back when they experience difficult times or changes in life.
 - You can make use of some common traits that people who are resilient have.
 - ✓ Seek purpose and meaning. Think about what you want in life. Is it a job? A family? You can have a job, a family, and most anything else that you want in life. The key is to set the goals you want to achieve and relentlessly strive to reach those goals.
 - ✓ Stay connected with your support network. Your family, friends, faith, and others in your community can be a great resource to help you adjust to life after SCI and reach your goals.
 - ✓ Use resources to make your life better. There are many organizations, agencies, and community resources that offer help to people with SCI. Here are a few:
 - The Job Accommodation Network (JAN; www.askjan.org) is the leading source of free, expert, and confidential guidance on workplace accommodations and disability employment issues. The JAN website also has a list of State Vocational Rehabilitation Agencies that can help you return to work.
 - The Independent Living Research Utilization (www.ilru.org) program has a list of Centers for Independent Living and Statewide Independent Living Councils throughout the United States. These centers are in every state. Your local center can provide you with information and direct you to local resources. You can work one-on-one with an independent living skills trainer. You can get



connected with others in your community if you need support and tips from a role model who is living independently. Your local center can also help with accessibility and equal access to community services as well as transition from nursing homes to community-based living.

- The Disability Services webpage on the USA.gov web site (<https://www.usa.gov/disability-services>) offers information on disability programs and services available from the government and in local communities nationwide.
- ✓ Stay flexible. When you set goals, you may not reach them exactly as planned. Setbacks are common, but you can adjust your efforts to reach your goals.
- ✓ Solve problems. You cannot avoid problems, and people with SCI who have good problem-solving skills tend to have a higher quality of life and fewer medical complications. Here is how you might approach solving problems.
 - Figure out what the problem or challenge is. Break big issues down into smaller, more manageable parts if needed and tackle one problem at a time.
 - Brainstorm. Think about all possible solutions and get input from family and friends. If another person is involved in the problem, make sure that person helps to brainstorm for solutions.
 - Choose the solution you think will work best. Make sure the solution is acceptable for everyone involved.
 - Try your solution to learn if it works.
 - Evaluate the results. You have solved your problem if your solution works. If not, brainstorm, choose another solution, and try it. Most solutions do not work perfectly the first time. Trying again and adjusting plans are keys to success.



Difficulty with adjustment

It is normal to have days when you feel down or bad after SCI. However, people who have continuing depression tend to have difficulty adjusting after SCI. Sometimes depression happens soon after SCI. In a few cases, depression begins some time later.

- People who become depressed usually fall into thinking and behavior traps. Talking with peers, professionals, family, or friends may help you see these traps and find solutions. Here are some examples of thinking and behavior traps.
 - Believe they have no control over their life rather than focusing on what they can control.
 - Depend on others more than they need to rather than seeking ways to become more independent.
 - Focus on the bad thing that might happen rather than on the good things that “could” happen.
 - Give up trying to deal with difficulties caused by SCI rather than working out these difficulties over time.
 - Focus on what they cannot do rather than on the meaningful or enjoyable activities that they are still able to do.



- More than 25% of people with SCI had difficulties with depression *before* they were injured. Being prone to depression, anxiety, or other mental health problems can make it harder to adjust to SCI. If you are in this situation, it may serve you well to have regular mental health services during and after rehabilitation.
- Pain is a common risk factor for depression. Learn more about the types of pain and treatment options by reading “Pain after Spinal Cord Injury” at www.msktc.org/sci/factsheets/pain. However, not all people who have pain after SCI become depressed.
- Talk to a professional if you think you might be depressed. Depression is treatable with medication and counseling. Learn more about depression and treatment options by reading “Depression and Spinal Cord Injury” at www.msktc.org/sci/factsheets/Depression.

Does family life change after SCI?

Relationships

Changes in family roles and relationships can be stressful for couples after SCI. It can take time for couples to find a new “normal” in their relationships. However, couples can work together to adjust over time and find the “new normal” in their relationship.



- Read “Sexuality and Sexual Functioning After SCI” to learn more about managing relationships, sex, and having children after SCI at <http://www.msktc.org/sci/factsheets/sexuality>.

Parenting

For any parent, raising a child is a learning process that is challenging and rewarding. The fact that you have limited mobility does not mean you are less able to parent. Parenting is much more about supporting your child with love, devotion, and guidance rather than what you can do physically.

- Be fully involved in making decisions about your children’s day-to-day activities, including discipline.
- Children are naturally curious and will likely ask many questions about your SCI. They usually adjust quickly when their questions are answered in terms they can understand.
- Unless you have a preexisting condition, having SCI does not prevent you from having children. In fact, people with all levels of SCI have children after SCI. You can, too, if you choose.

How can I be independent if I have to rely on others for help?

During rehabilitation, you learn how to do as much as you can on your own. These skills help to lessen your reliance on help from others.



Still, you will likely need some type of help to do the things that you cannot do. Asking for help is sometimes difficult to accept. Here are two questions to consider if you are hesitant to ask for help.

1. How do you view independence? It is common to think of independence as being able to do everything on your own. However, most people depend on others. You can probably think of many examples when you relied on others before your SCI. You may have depended on a mechanic for car repairs or a friend or relative for picking the kids up from school. After SCI, it is helpful to think of independence as actually being in control of your life. Being in control means making decisions for yourself, learning how to best care for yourself and direct your personal care, and being an active voice in the decisions that affect you and your family.



2. Do you feel like you are a “burden” on those who help you? It is common to feel like a burden to a spouse or caregiver who does the physical tasks that you may no longer be able to do. You may hesitate to ask for help or speak up for something you want or need. However, you can help limit their stress by making decisions together. Open communication is one of the best ways to solve problems and reduce stress for everyone.

What adjustments do I need to make to manage my health?

All aspects of your health and wellness are important. If you stay healthy, you are more likely to stay active, reach your life goals, and maintain a high quality of life. Although people who help with your care need to know about your medical needs, you are responsible for managing your health and directing your care.

- Learn about your risks for secondary medical conditions, how to prevent them from occurring, and what to do if you have a medical problem.
- It is important to have a healthy diet and stay active. Think about the activities you enjoyed before your SCI. Those same activities can still be enjoyable even though you may need to make adjustments in the way you do them. You can also find new ways to stay active.
 - The National Center on Health, Physical Activity and Disability (www.nchpad.org) is a great resource for lifestyle information.
- Schedule annual follow-up visits with your SCI specialist and your primary care provider.
 - Your SCI specialist is well trained to manage the unique medical issues of SCI but does not usually provide primary care services.
 - Your primary care provider is not trained in SCI issues but is trained to provide the health care services that everyone needs, such as treating common illnesses and providing preventive medicine. They watch for early signs of medical problems and refer patients for specialized care when needed.



Who can I talk to if I have problems or questions?

It is common to have problems with no easy solutions or questions with no easy answers. If so, you are not beyond help and do not have to be on your own.

You can seek input from multiple sources to help you with important issues. Family, friends, spiritual advisors, mental health professionals, and people with SCI can be very helpful and supportive. There are a lot of good resources on the internet. However, be mindful that some websites and social media sites may contain incorrect information.

Few people are well informed enough about SCI to provide the best advice, so your best sources for advice and information are usually professionals who are experienced with SCI issues.

- A physical or occupational therapist can help with activities of daily living.
- A doctor or nurse who is an SCI specialist can help with medical needs.
- A counselor, psychologist, or social worker can help with concerns about mood, anxiety, relationships, substance use, and getting back into enjoyable and meaningful activities. They can help couples and with family issues, too.



- When searching the internet for information, start your search by going to websites managed by a Spinal Cord Injury Model System. You can find a directory of SCI Model Systems at <http://www.msktc.org/sci/model-system-centers>
- If you are searching for peer support, you might start with two of the most reputable online support websites.
 1. The United Spinal Association (www.unitedspinal.org) provides information and resources to meet the needs of people with SCI and their families and friends.
 2. FacingDisability.com (www.facingdisability.com) provides internet-based information and support for people with SCI and their families. The website has more than 1,000 videos of people discussing real-life issues they faced after SCI.



Authorship

Adjusting to Life After Spinal Cord Injury was developed and updated by Phil Klebine, MA; Charles Bombardier, PhD; and Elizabeth Richardson, PhD, in collaboration with the SCI Model Systems Knowledge Translation Center.

Source: The content in this factsheet is based on research and/or professional consensus. This content has been reviewed and approved by experts from the Spinal Cord Injury Model Systems (SCIMS) centers, funded by the National Institute on Disability, Independent Living, and Rehabilitation Research (NIDILRR).

Disclaimer: This information is not meant to replace the advice of a medical professional. You should consult your health care provider about specific medical concerns or treatment. The contents of this factsheet were developed under a grant (number 90DP0012) from the National Institute on Disability, Independent Living, and Rehabilitation Research (NIDILRR). NIDILRR is a Center within the Administration for Community Living (ACL), U.S. Department of Health and Human Services (HHS). It was updated under grants (numbers 90SI5019 and 90DPKT0009) from NIDILRR. The contents of this factsheet do not necessarily represent the policy of NIDILRR, ACL, or HHS and you should not assume endorsement by the federal government.

Recommended Citation: Klebine, P., Bombardier, C., & Richardson, E. (2022). *Adjusting to life after spinal cord injury*. Model Systems Knowledge Translation Center (MSKTC). https://msktc.org/sci/factsheets/adjusting_to_life

Copyright © 2022 Model Systems Knowledge Translation Center (MSKTC). May be reproduced and distributed freely with appropriate attribution. Prior permission must be obtained for inclusion in fee-based materials.



Things to Know About Aging and Spinal Cord Injury

November 2018

www.msktc.org/sci/factsheets

SCI Fact Sheet

This fact sheet explains some of the changes in your body as you get older. It lists ways to care for your health with a spinal cord injury.

What Do You Need to Know and Do?

Aging affects everyone. It is just another step along the path of life. But a spinal cord injury (SCI) can speed up the aging process, and other health problems can become more common with age. This factsheet can help you manage your health and SCI as you get older and will explain the importance of maintaining a healthy lifestyle after a SCI, including how to:

- Learn about the issues people with SCI may experience as they age and common health conditions associated with the injury (“secondary” health conditions).
- Follow a self-care routine to reduce health problems.
- Decide what will help you enjoy a good quality of life and seek help when needed.
- Become aware of factors in the environment and how to overcome barriers.
- Work with your doctor and health care providers to spot potential problems.
- Get regular health check-ups from your doctor and keep learning from research.

Why Is Aging an Important Issue for People With SCI?

Our body slows down as we age. Many things that were easy become harder with age. This is true for everyone, including people with SCI. People with SCI are living longer because of better health care. As you age, you may have health problems that you never had when you were younger. “Chronic” health problems are ones that last six months or more and require ongoing medical care. They may limit activities of daily life. They may result from common age-related problems, such as arthritis, which affects many middle-aged and older adults. Chronic conditions may be related to SCI. When chronic conditions are related to SCI, they are called “secondary health conditions.” New health problems may:

- Happen more often in people who are aging with physical disabilities;
- Result from complications from SCI or its treatments;
- Come from over-, under-, or misusing a body system, such as shoulder pain from pushing a wheelchair; and
- Result from lifestyle behaviors and factors in the environment, such as limited transportation options or fewer opportunities to be involved in healthy recreational activities.

We have learned much from research in the past 20 years:

1. People with SCI show signs of aging earlier than those without SCI. Several organ systems in people with SCI may not work as well as those of same-aged people without SCI. Earlier aging is more likely to affect the musculoskeletal (muscles and bones), endocrine (glands), and cardiovascular (heart) systems in people with SCI.
2. People with SCI are more likely than the general population to experience chronic pain, bone loss, pressure injury (pressure sores), and kidney and bladder stones.

The Spinal Cord Injury Model System is sponsored by the National Institute of Disability, Independent Living, and Rehabilitation Research, U.S. Department of Health and Human Services' Administration for Community Living. (See <http://www.msktc.org/sci/model-system-centers> for more information).



Body Changes From Aging

Some body systems lose function with age. The degree of loss varies for each person. How a person ages after SCI is based on several factors, such as:

- Level and severity of injury,
- Age at injury,
- Family health history,
- Lifestyle behaviors (for example, activity levels, smoking or alcohol use, and diet), and
- Access to community services and social supports.

A symptom or change in a condition may be “normal” aging or the sign of a problem. Discussing your symptoms with your doctor can help you figure this out. The following table describes body changes that come with normal aging and aging with SCI. It also provides ideas to reduce secondary health conditions and help you age well.

Body system	Typical aging	Aging with SCI	What can you do?
Muscles and bones	Reduced flexibility, loss of muscle strength, lower bone mass, higher chance of broken bones, pain, and joint stiffness or pain from arthritis	Increased difficulty performing daily activities such as transfers, injury or arthritis in shoulders, arms, and hands for people who use wheelchairs or bear weight in their arms, chronic pain, and changes within the spinal column itself (such as a scoliosis)	Avoid pain-causing and repetitive movements, avoid weight gain, engage in strengthening exercises to maintain arm strength and improve muscle balance across joints (such as lifting weights), assess equipment and chairs to reduce pain and maximize healthy posture and positions, maximize technology that reduces the stress on your joints (such as using a lift or sliding board), and lay flat to stretch
Skin	Reduced flexibility, thinner outer layer, longer time to heal wounds	Pressure injuries from being in one position for a long time or not staying dry because of incontinence (a lack of bladder control); injury due to lack of sensation; with aging, pressure sores may become more likely, even if they had not occurred before	Check skin for pressure injuries (pressure sores), perform pressure reliefs, avoid injury, watch for changes in skin and moles, use sunscreen, drink plenty of liquids, and routinely examine your equipment for breakdown or wear and tear that may cause extra pressure on skin
Immune system	Reduced ability to fight infection, reduced benefit from vaccines, and a higher chance of autoimmune diseases	Increased chance of infection, increased chance of resistance to antibiotics and other medicines	Use clean, sterile, or aseptic bladder management techniques, get routine vaccinations, eat a balanced diet, get plenty of sleep and exercise, and reduce stress
Lungs	Decreased lung function	Weaker lung muscles due to chest or abdominal weakness, less physical activity, and a higher chance of infection and blood clots	Test breathing periodically, get routine vaccinations, maintain a healthy weight, and don't smoke
Kidneys and bladder	Decreased kidney and bladder function, higher chance of urinary tract infections	Urinary tract infections, kidney damage from retaining urine, a higher risk of stones in the kidneys and bladder, and urethral damage or limitation from prolonged use of catheters	Drink plenty of water, get regular check-ups of your kidneys and bladder, and discuss alternative bladder emptying method options with your doctor



Body system	Typical aging	Aging with SCI	What can you do?
Gastrointestinal (digestive) system	Decrease in bowel contractions, trouble digesting some foods, and decreased ability to absorb vitamins and minerals	Constipation or incontinence, taking longer to digest food, need for bowel medicines, hemorrhoids caused by older age and longer duration of injury, and gallbladder disease	Maintain a healthy diet and regular bowel program, and consider other options if bowel is hard to manage
Spinal cord and nerves	Slower reaction time; less strength; decreased coordination and reflexes; trouble walking; and increased nerve damage, such as carpal tunnel syndrome	Over- or misuse of muscles and bones leading to nerve damage; changes within the spinal cord itself (such as a cyst)	Refer to transfer guidelines to make sure you are using the correct technique, reduce the number of transfers, make home and work modifications to minimize stress on the arms, use sliding boards, see a physician if needed as surgery may help release trapped nerves, and watch for changes in feeling and strength
Heart and blood vessels	Higher chance of heart disease, high blood pressure, higher cholesterol, and higher glucose intolerance	Obesity, decrease in “good” cholesterol (or HDL), and fewer benefits from aerobic exercise	Get regular check-ups to monitor problems with cholesterol, glucose, weight, and blood pressure; eat a heart healthy diet; and stay active

Feelings and Emotions

People usually live fulfilling and pleasurable lives without experiencing major emotional problems as they age. In fact, most older adults, with and without SCI, are resilient and adjust well to changes in their physical abilities. They also note improved relationships with loved ones, increased appreciation for life, and changes in priorities.

Your doctor plays an important role in your life as you age with SCI. Visit your doctor regularly to get physical check-ups. Talk to your doctor about your emotions and physical independence. High levels of anxiety, depression, and stress are not a normal part of aging. Talk with your doctor or a counselor if you’re frequently worrying, losing interest or pleasure, or feeling “blue” most of the day.

Keys to Successful Aging

Everyone ages; it is a natural part of all life. The choices you make as you age with SCI are just as important as earlier life events, such as participating in initial rehabilitation, returning to work, developing relationships, and participating in life’s activities. To help handle changes as you age, keep a positive outlook and visit your doctor regularly.

Aging successfully with SCI means maintaining your physical health and independence as much as possible. It also means adapting to new limitations, staying emotionally healthy, and participating in activities that are important and meaningful to you.

To age successfully with SCI:

- Don’t be afraid to change the way you do some activities, if needed, for example, having a different diet;
- Use adaptive equipment appropriately—equipment to help you with everyday tasks. Examples include wheelchairs, special beds, cushions, and braces;
- Seek help from others as needed but keep a steady level of independence. Even as you age with SCI, independence of mind is still realistic. You can continue to make decisions and direct health- and care-related issues, such as hiring, training, and firing helpers;
- If possible, find more accessible housing; and
- Take part in social activities that you value.



To keep a positive outlook:

- Connect with others;
- Engage in regular physical activity;
- Participate in enjoyable activities;
- Learn something new; and
- Volunteer or seek services and supports provided by community-based organizations, such as independent living centers, aging and disability resource centers, and faith-based organizations.

Maintaining your physical health is another way to age successfully. Your doctor plays a key role in this process. Be sure to get regular health check-ups from your doctor. Work with your doctor and counselor to find and treat potential medical conditions and problems. Keep learning from research. Follow a health plan as you age. See the Medical Care Guidelines that follow. Discuss these guidelines with your doctor.

Medical Care Guidelines for Aging With SCI

(Recommendations may vary by age, ethnicity, family history, and other factors)

General health maintenance	SCI-specific maintenance
Things to do every month <ul style="list-style-type: none"> • Women: breast self-exam • Men: testicular self-exam 	Things to do every day <ul style="list-style-type: none"> • Self-skin check • Stay active – follow the Physical Activity Guidelines for Individuals with Disabilities • Eat and drink responsibly
Things to do every 1–2 years <ul style="list-style-type: none"> • Physical check-up with your doctor • Fecal occult blood test • Women: mammography, 40 years of age and older • Men: digital rectal exam and PSA (prostate specific antigen) test, beginning at 75 years of age • Comprehensive eye exam, 55 years of age and older 	Things to do every 1–2 years <ul style="list-style-type: none"> • Check weight and blood pressure • Annual flu shot, especially for people with injuries at T8 and higher
Things to do every 2–3 years <ul style="list-style-type: none"> • Complete blood count with biochemistry • Women: breast cancer exam by a doctor • Women: gynecological exam and Pap test 	Things to do with SCI specialist or team each year during the first 3–5 years after injury <ul style="list-style-type: none"> • Full history and physical check-up with doctor • Assess adaptive equipment and posture • Assess range of motion, contractures, and function • Full skin check • Bladder and urethra exam; also do this each year for the first 3 years after any major change in urologic management
Things to do every 5 years <ul style="list-style-type: none"> • CT (computerized tomography) scan or X-ray of the colon • Screening sigmoidoscopy, which allows your doctor to look inside your large intestine, beginning at 50 years of age • Full lipid panel, beginning at 35 years of age for men and 45 years of age for women 	Things to do at least every 5 years with SCI specialist or team <ul style="list-style-type: none"> • Motor and sensory testing • Review changes in life situation, including coping, adjustment, and life satisfaction • Assess lung function, to include how much air you can exhale during a forced breath at 1 second and the total amount of air you can exhale during a lung capacity test



General health maintenance	SCI-specific maintenance
Things to do every 10 years <ul style="list-style-type: none"> • Tetanus booster • Colonoscopy, which allows your doctor to examine your colon, beginning at 50 years of age 	Things to do every 10 years <ul style="list-style-type: none"> • Same as for general population
Things to do one time <ul style="list-style-type: none"> • Centers for Disease Control and Prevention (CDC) recommends 2 pneumococcal vaccines for all adults 65 years or older <ul style="list-style-type: none"> ○ You should receive a dose of PCV13 first, followed by a dose of PPSV23, at least 1 year later ○ If you already received any doses of PPSV23, get the dose of PCV13 at least 1 year after the most recent PPSV23 dose ○ If you already received a dose of PCV13 at a younger age, CDC does not recommend another dose 	Things to do one time Same as for general population

Authorship

Things to Know About Aging and Spinal Cord Injury was developed by the SCI Aging Special Interest Group of the SCI Model Systems in collaboration with the Model Systems Knowledge Translation Center and investigators from the University of Washington Healthy Aging Rehabilitation and Research Training Center.

Source: The health information content in this fact sheet is based on research evidence and/or professional consensus and has been reviewed and approved by an editorial team of experts from the Spinal Cord Injury Model Systems.

Disclaimer: This information is not meant to replace the advice of a medical professional. You should consult your health care provider about specific medical concerns or treatment. The contents of this fact sheet were developed under a grant from the National Institute on Disability, Independent Living, and Rehabilitation Research (NIDILRR grant number 90DP0082). NIDILRR is a Center within the Administration for Community Living (ACL), Department of Health and Human Services (HHS). The contents of this factsheet do not necessarily represent the policy of NIDILRR, ACL, HHS, and you should not assume endorsement by the Federal Government.

Copyright © 2018 Model Systems Knowledge Translation Center (MSKTC). May be reproduced and distributed freely with appropriate attribution. Prior permission must be obtained for inclusion in fee-based materials.



Autonomic Dysreflexia

November 2015

www.msctc.org/sci/factsheets

SCI Fact Sheet

Autonomic dysreflexia (AD) is a medical condition that can lead to serious stroke, seizure, organ damage, permanent brain injury, or even death if not treated immediately. This fact sheet will help you better understand AD and prepare you for what to do if you get it.

What is Autonomic Dysreflexia?

Autonomic Dysreflexia (AD), sometimes referred to as Autonomic Hyperreflexia, is a potentially life-threatening medical condition that many people with spinal cord injury (SCI) experience when there is a pain or discomfort below their level of injury, even if the pain or discomfort cannot be felt.

Am I at risk for AD?

- People with injury levels at or above T6 are at risk for AD.
 - Read Understanding Spinal Cord Injury Part 1 to learn about levels of injury at www.msctc.org/lib/docs/Factsheets/SCI_Understand_Spin_Crd_Inj_Prt1.pdf.
- People with injury levels below T6 may also be at risk for AD in some rare situations.

Why do people with SCI get AD?

AD happens because there is a change in the body's autonomic reflexes after injury.

Autonomic Reflexes before SCI

The autonomic nervous system controls body functions like blood pressure, heart rate, body temperature, sweating, digestion, sexual function, and dilation of your eyes' pupils through signals sent back and forth from the brain and body through the spinal cord nerves. These functions are largely automatic or involuntary, meaning they are controlled without you thinking about it.

There are two main systems within the autonomic nervous system.

- Sympathetic nervous system – this is the body's involuntary “fight or flight” response to prepare the body for action when there is some type of stress or threat. Pupils are dilated; the heart rate increases; the heart pumps with more force; and blood vessels get narrower causing blood pressure to rise.
- Parasympathetic nervous system – this is the “rest and digest” response. It causes digestion to improve, the heart to pump more slowly and with less force, and blood vessels get wider causing blood pressure to lower.

The body's first reaction to pain or discomfort is to go into the sympathetic, “fight or flight” mode. However, the brain usually reacts quickly and sends a parasympathetic, “rest and digest” response to counteract the sympathetic response. This normally creates the balance needed to prevent the body from overreacting to any pain or discomfort and staying in that “fight or flight” mode.

Autonomic Reflexes after SCI

Your body's first reaction to pain or discomfort below your injury level is still to go into the sympathetic, “fight or flight” mode. Your brain then tries to send the parasympathetic, “rest and digest” response to counteract the sympathetic response, but your SCI blocks the signals from reaching the spinal cord below your injury level. The “rest and digest” response only reaches those areas above your injury level, and this allows the “fight or flight” mode to continue out of control below your injury level.

Why is AD life-threatening?

AD is life-threatening because blood pressure can rise to dangerous levels when your body stays in that “fight or flight” mode.

The Spinal Cord Injury Model System is sponsored by the National Institute of Disability, Independent Living, and Rehabilitation Research, U.S. Department of Health and Human Services' Administration for Community Living. (See <http://www.msctc.org/sci/model-system-centers> for more information).



Blood Pressure before SCI

The heart pumps blood to all parts of the body via blood vessels called arteries. Blood pressure is the force of the blood as it pushes against the walls of the arteries.

Blood pressure is always given as two numbers.

- Systolic (top number) is the pressure in the arteries when the heart squeezes to pump blood.
- Diastolic (bottom number) is the pressure in the arteries when the heart relaxes.

Most people have a normal baseline blood pressure of about $\frac{120\text{mmHg}}{80\text{mmHg}}$. Blood pressure changes depending on what a person is doing. For example, blood pressure can be higher during exercise or when a person is in pain. Blood pressure can be lower during rest or sleep. The brain monitors these changes and uses the autonomic nervous system to keep blood pressure in balance.

Blood Pressure after SCI

Blood vessels around the bowels, which represent a large portion of the circulatory system that influences overall blood pressure, are controlled by nerve signals below T6. This is why people with injuries at T6 or above have difficulty keeping blood pressure in proper balance.

- Baseline blood pressure may be lower for some people with SCI, somewhere around the $\frac{90-110\text{mmHg}}{50-60\text{mmHg}}$ range.
- AD occurs when a pain or discomfort somewhere below the T6 level of injury causes your systolic blood pressure to rise 20mm to 40mm higher than your normal baseline or your diastolic blood pressure to rise 15mm to 20mm higher than your normal baseline.
- Your blood pressure will continue to be high until the cause of the pain or discomfort is resolved. If not, the rise in blood pressure can lead to uncontrolled high blood pressure emergencies (hypertensive emergencies).
 - Hemorrhagic stroke (a rupture or leak in a blood vessel in the brain)
 - Organ damage (heart attack, heart failure, kidney failure)
 - Seizures (changes in the brain's electrical activity)
 - Death

What can trigger AD?

AD can be triggered by anything that might normally cause pain or discomfort below your level of injury even if you cannot feel the pain. Here are the most common areas of concern.

- Bladder (#1 cause of AD) – the bladder is full and needs to be emptied. People who use indwelling (Foley) catheters, condom catheters (sometimes referred to as sheaths) or suprapubic catheter usually have a kink/blockage of urine flow causing the AD.
- Bowel – constipation, flatus (gas), bowel needs emptying, or hemorrhoids are inflamed.
- Skin – there is a pressure ulcer, pinched skin, cut, ingrown toenail, something too hot or cold touching the skin, or another problem.
- Broken bone
- Sexual activity
- Menstruation (women)

What are the symptoms of AD and how do I know if I am having it?

The symptoms of AD are caused by the rising blood pressure. Symptoms vary from person to person, and there are some reports of no symptoms but high blood pressure during urination, bowel programs, bladder studies (urodynamics), and sperm retrieval. However, people usually experience one or more symptoms that are fairly easy to recognize.

- Pounding headache
- Slow pulse (although rare, a fast pulse can occur)
- Skin redness or flushing
- Chills without fever
- Restlessness
- Sweating above the level of injury
- Goose bumps
- Nasal congestion
- Blurred vision
- Cold and clammy skin below the level of injury

What do I do if I have AD?

Most people with a T6 level of injury or above experience AD after injury. They also learn to recognize symptoms and know it is important to quickly act to find the source of the problem and fix it. Here is a checklist you can follow to resolve AD whenever you are experiencing it. Get help from a caregiver if needed.

- ✓ Check your blood pressure. Everyone at risk for AD needs to have a home blood pressure monitor and know how to use it.
 - Check your blood pressure about every five minutes while you try to find the cause of the AD episode.
 - If your systolic blood pressure is greater than 150 mmHg, then consider using some medication to lower it. Nitropaste applied to the skin above the level of injury is most commonly recommended. Wipe off the nitropaste once blood pressure is stable. Caregivers should wear gloves when applying the medication.
- ✓ Find the cause of AD and fix the problem if you can.
 - Sit upright.
 - Loosen any tight clothing or anything else that might be tight fitting.
 - Check to see if bladder is too full.
 - Is your catheter tube kinked or a condom catheter on too tight?
 - Does your bladder need emptying?
 - Check to see if your bowel is full.
 - If you have lidocaine gel, you can use it to numb the anal area before you check your bowel. This can help prevent causing more discomfort as you are checking.
 - Check skin for a pressure sore, inflamed hemorrhoids, cuts, burns, ingrown toenails, or any other skin irritation.
 - Check for broken bones.
- ✓ If you are unable to identify the cause of AD and/or control your blood pressure with the medications that you have, then you will need to seek medical attention. Call 911.
 - Clip the card (at the end of the factsheet) to carry with you. Give it to medical professionals to assist them in treating AD.

Is there treatment for AD?

It is important to know what your baseline blood pressure usually is because it will help you know when you have AD and need to take action. AD will resolve if you follow the steps above to find the source of the problem and fix it. However, AD can occur without any obvious or easily treated cause and you may need to be hospitalized to manage your blood pressure while doctors search for the cause of the AD. Once you have identified the cause of an AD episode, you might need to make some changes in the way you do things to prevent future episodes.

Can I prevent AD?

Good ongoing personal care is the best way to prevent AD.

- Maintain a consistent bladder program and take necessary steps to prevent infections.
- Maintain a consistent bowel program.
- Check your skin daily for pressure ulcers, and do regular pressure reliefs (also called weight shifting, pressure redistribution and pressure reduction) to prevent pressure ulcers.
- Avoid other skin injuries such as cuts, bruises and sunburn.
- Make sure you wear loose clothing and avoid clothes and shoes that are too tight.
- Use good techniques and well-functioning equipment to minimize the risk of falls and injuries.

Keep this wallet card with you at all times. Give it to medical professionals to assist them in treating AD.

Fold along solid Line

Cut along dotted Line

MEDICAL ALERT	AD Examination Tree
<p>Autonomic Dysreflexia (AD) is a potentially life-threatening condition that occurs in persons with spinal cord injury (SCI) at the T6 level and above, even in the absence of sensation. In rare circumstances, AD can occur in persons with levels of SCI below T6.</p> <p>Cause: AD is a reaction to noxious stimuli to intact sensory nerves below the SCI level leading to relatively unopposed sympathetic outflow and elevated blood pressure (BP). Parasympathetic outflow through cranial nerve X (vagus) can cause reflexive bradycardia but cannot compensate for severe vasoconstriction. Seizures, stroke, or death may occur if stimuli are not removed.</p> <p>Symptoms: Hypertension, Chills without Fever, Pounding Headache, Bradycardia, Sweating above Injury Level, Nasal Congestion, Blurred Vision, Skin Flushing above Injury Level, Goose Bumps above Injury Level, Bronchospasms, Apprehension or Anxiety, and Seizures</p> <p>Treatment: Sit patient up. Take BP and retake after each step of AD examination tree (reverse side). Normal systolic BP for persons with T6 SCI and above can be in the 90-110mmHg range. If BP is elevated >150mmHg, use antihypertensive (consider nitropaste if no contraindications) with rapid onset and short duration while following the treatment steps to investigate the source of AD below injury level.</p>	<p>Follow steps below to identify noxious stimuli below the injury level. If possible, add local anesthesia to noxious stimuli prior to removal to prevent exacerbation. BP drop occurs with stimuli relief.</p> <ol style="list-style-type: none"> 1. Check Bladder for Distention: Catheterize bladder using 2% lidocaine gel. If indwelling catheter already in place, inspect for kinks or obstructions. Irrigate or replace the catheter to insure patency. 2. Check Bowel: Anesthetize lower bowel using lidocaine gel 2% (wait 5 minutes) prior to checking for impaction. 3. Check Skin: Remove constricting clothing. Examine for pressure ulcers, insect bites, burns, abrasions, cuts, etc. 4. Men: Remove condom catheter if too tight. Genitalia pinched? Reflexogenic erection? 5. Female: Menstrual cramping? Intrauterine devices? Vaginitis? 6. Miscellaneous: Fractures? Urinary tract stones or infection? Ingrown toenail? Venous thromboembolism? Pneumonia? Retroperitoneal, intramuscular, intravesical hematoma? Spine or joint pathology? <p>Monitor AD symptoms and BP for at least 2 hrs after drop in BP with relief from stimuli. Admit patient if unresponsive to treatment or stimuli cannot be found.</p>

Authorship

"Autonomic Dysreflexia" was developed by Anthony Chiodo, M.D., Deborah A. Crane, M.D., Maria R. Reyes M.D., Shawn Song, M.D. and Phil Klebine, M.A., in collaboration with the SCI Model Systems Knowledge Translation Center.

Disclaimer: This information is not meant to replace the advice of a medical professional. You should consult your health care provider regarding specific medical concerns or treatment. The contents of this fact sheet were developed under a grant from the National Institute on Disability, Independent Living, and Rehabilitation Research (NIDILRR grant 90DP0012). NIDILRR is a Center within the Administration for Community Living (ACL), Department of Health and Human Services (HHS). The contents of this fact sheet do not necessarily represent the policy of NIDILRR, ACL, HHS, and you should not assume endorsement by the Federal Government.

Copyright © 2015 Model Systems Knowledge Translation Center (MSKTC). May be reproduced and distributed freely with appropriate attribution. Prior Permission must be obtained for inclusion in fee-based materials.

Bladder Management Options Following Spinal Cord Injury

September 2015

www.msktc.org/sci/factsheets

SCI Fact Sheet

This fact sheet tells you about some of the more common methods to manage your bladder if it is not working correctly following your spinal cord injury

What you need to know

- Your spinal cord injury (SCI) might limit your ability to control your urine. You might not be able to stop urine from flowing, or you might not be able to release it.
- Uncontrolled urination or inability to empty your bladder can have a negative effect on your quality of life and cause bladder and kidney infections and other problems.
- Appropriate bladder management can help keep your bladder and kidneys healthy.
- Each type of bladder management option has pros and cons.
- Your doctor can help you choose the bladder management option that best meets your needs and lifestyle, and keeps your bladder and kidneys healthy.

Understanding your body

- The kidneys remove waste from your body through your blood stream. This waste becomes urine.
- The urine passes down the ureters (pronounced YOU-ret-erz) into the bladder. The sphincter (pronounced SFINK-ter) muscle at the end of the bladder acts like a valve that you can tighten to keep urine from leaving your body. (When you urinate, your sphincter normally relaxes and your bladder squeezes to push the urine out of your bladder).
- Urine passes from the bladder through the urethra (pronounced yur-EETH-rah) out of your body. In women, the urethra is right above the vagina. In men, the urethra is in the penis. The inability to control the release of urine is called urinary incontinence (pronounced in-KAHN-ten-ans). The inability to release urine from your bladder when it is full is called urinary retention.

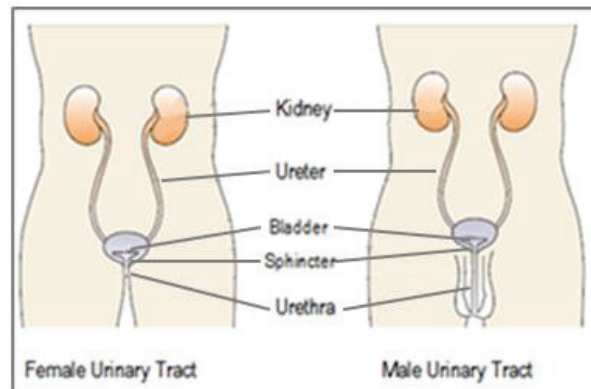

What does my spinal cord have to do with my bladder?

- Your brain sends and receives signals through your spinal cord. At the lowest part of your spinal cord (see **MSKTC factsheet entitled *Understanding SCI Part 1*** http://www.msktc.org/lib/docs/Factsheets/SCI_Understand_Spin_Crd_Inj_Prt1.pdf) is an area called the sacral micturition (pronounced SAY-krul mich-ter-ishun) center that has nerves attached to it that go to and from the bladder. These nerves help to signal the brain when the bladder needs to be emptied. They also control the sphincter.
- For example, if you need to hold your urine until a convenient time to empty your bladder, your brain will signal the bladder not to squeeze and the sphincter to tighten so that you can wait. When it is time to release your urine, signals from your brain will then send signals down your spinal cord to squeeze the bladder and relax the sphincter. If an SCI has damaged the spinal cord, the signals from the brain to the bladder do not work correctly and you might not be able to control your urine. You might not be able to stop urine from flowing (urinary incontinence), or you might not be able to release it (urinary retention).

The Spinal Cord Injury Model System is sponsored by the National Institute of Disability, Independent Living, and Rehabilitation Research, U.S. Department of Health and Human Services' Administration for Community Living. Opinions expressed in this fact sheet are not necessarily those of the granting agency. (See <http://www.msktc.org/sci/model-system-centers> for more information).



What bladder problems can an SCI cause?

An SCI can cause two types of bladder problems. One set of problems occurs immediately after injury, and the other may begin later on after your injury (long term) when you are out of spinal shock (see below)

Immediately after SCI:

- You might experience spinal shock, when signals from the brain can't get to any or most parts of the body below the spinal cord injury.
- Spinal shock in general usually lasts for up to a few days, but for the bladder it can last several months or longer.
- Your bladder does not squeeze when you are in the period of spinal shock.

After your bladder is out of spinal shock:

- Signals to and from your brain may still be blocked by the SCI.
- Your sacral micturition center is an area of the spinal cord at the base of the spine. This is the area of the spinal cord that controls your bladder and sphincter.
- After spinal shock, your sacral micturition center it might start sending signals on its own to tell the bladder to squeeze. In addition, signals that would normally come down from your brain to keep your sacral micturition center from sending signals to make your bladder squeeze are blocked by your SCI. Therefore your bladder begins to squeeze and possibly cause you to also urinate without control (urinary incontinence). This is known as a "neurogenic overactive bladder."
- Your sphincter might tighten or relax on its own, starting and stopping your urine stream without your control.
- Your bladder might try to squeeze but the sphincter might tighten at the same time, making you unable to urinate and causing a high-pressure buildup in the bladder. This is known as detrusor (bladder) sphincter dyssynergia (pronounced dis-IN-ergh-IAH). This can stretch your bladder beyond what is healthy and can cause bladder infections.
- High pressures in your bladder can also prevent urine from draining from your kidneys to your bladder and can cause kidney infections, kidney stones, and even kidney damage.
- Another problem that can occur in those with SCI at T6 and above is autonomic dysreflexia. This can happen when something causes pain or discomfort to your body even though you may not feel it. The two most common causes are bladder distention (and bladder contractions) and constipation. Autonomic dysreflexia causes a sudden severe elevation in blood pressure which has the potential of being dangerous. Autonomic dysreflexia may or may not (silent autonomic dysreflexia) cause other symptoms such as headache, flushing, and/or goose bumps. It will not get better until the cause of the autonomic dysreflexia is taken care of, such as emptying the bladder. (See the reference below for more details on acute autonomic dysreflexia.)
- Over time there are also risks of having other problems such as bladder or kidney infections and a slight risk of developing bladder cancer, bladder or kidney stones, or kidney damage.

Does the level of injury on my spine affect what problems I experience?

- Yes, however everyone's bladder and sphincter act a little differently because the amount of nerve injury is a little different for each person even if you have the same level of injury as someone else.
- Keeping that in mind, the major areas to consider are:
 1. At or below the sacral micturition center
 2. Above the sacral micturition center.

At or Below the Sacral Micturition Center:

- If the SCI damaged the spinal cord at or near the base of your spine, the sacral micturition center might be damaged.
- When this center is damaged, signals can't be sent to the bladder to tell the bladder to squeeze (neurogenic underactive bladder).
- If the damage is below your sacral micturition center then even though signals are sent towards the bladder, the nerves to the bladder are damaged so the signals do not reach the bladder and your bladder will not squeeze.
- Your bladder will then become very full (over distended).
- If you have a weak urinary sphincter, urine will probably overflow from your bladder without your control (urinary incontinence).
- If you have a strong urinary sphincter, urine may not be able to be released leading to a possible increase in bladder pressure and possible back-up of urine in your kidneys.



Above the Sacral Micturition Center:

- The sacral micturition center sends signals to your bladder causing it to squeeze. Your spinal cord injury also blocks signals coming down from the brain which are telling the bladder when and when not to squeeze, causing you to have an overactive bladder. (See above section.)
- Signals also don't usually get to your urinary sphincter to tell it to relax when your bladder is squeezing (detrusor sphincter dyssynergia). (See above section.)
- If your injury is at T6 or above you may get autonomic dysreflexia from your overactive bladder and detrusor sphincter dyssynergia.

How can I know if my bladder and sphincter are working correctly?

Doctors can do a urodynamics (pronounced yur-oh-di-NAM-iks) test to see how well your bladder and sphincter are working:

- A catheter (a small tube) goes up through your urethra into the bladder.
- Your bladder is slowly filled with fluid.
- Doctors then measure how your bladder and sphincter respond to the fluid in the bladder.
- The test can help inform which bladder management option is best for you.

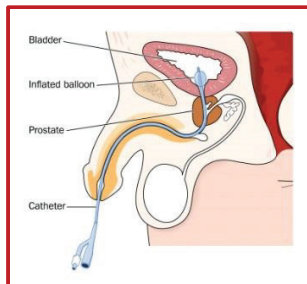

What is bladder management?

Bladder management is an ongoing set of treatments and practices that help keep your bladder and kidneys healthy and free from infection and other problems.

- Bladder management cannot fix or solve the problems caused by your SCI, but it can help you manage them to improve your health and quality of life. With appropriate management you can prevent incontinence and damage to the kidneys.
- You can work with your doctor to choose which bladder management option fits into your lifestyle and maintains bladder and kidney health.

What are some types of bladder management?

There are many types bladder management following SCI, each with various advantages and disadvantages. Several of the more common types of bladder management are listed below. It is important to speak with your health care provider to determine which option is best for you.

If you continue to have significant problems affecting your kidneys or bladder or your lifestyle despite non-surgical bladder management options, your doctor might in rare cases suggest a surgical option such as a urinary diversion. For more information on surgical management, see [MSKTC factsheet entitled *Surgical Alternatives for Bladder Management Following SCI*](http://www.msktc.org/sci/factsheets/bladdersurgery) <http://www.msktc.org/sci/factsheets/bladdersurgery>. This fact sheet will focus on some of the more common non-surgical options of bladder management.

Intermittent Catheterization (pronounced kath-et-er-iz-AY-shun)

This option is used for draining your bladder without keeping a catheter in your bladder all the time.

- You (or someone else) insert a catheter into your bladder to keep your bladder from getting too full.
 - To do this, pass the catheter up your urethra into the bladder. The urine drains out the other end.
 - When done, remove the catheter and return to normal activities.
 - Do this as often as needed (usually 4-6 times per day). The goal is to keep your catheterization volumes less than 500 ml. (about 17 fl oz) so you may have to catheterize more or less often depending on how much you drink.
 - You will often need medication or injections (such as Botox) to keep your bladder quiet in order to prevent leaking and high pressures in your bladder.

- This option might NOT be for you if:
 - You are unable to catheterize yourself (or don't have someone to help you).
 - Your bladder is very small (so you would have to catheterize your bladder very frequently).
 - Your bladder is overactive (even with treatment; so you may have high bladder pressures or incontinence).
 - Your sphincter is overactive (will not relax easily; so the catheter will not pass easily into your bladder).
 - Your sphincter is underactive (will not tighten; so you will have frequent urinary incontinence).
 - You have a false passage in your urethra (so the catheter may get caught in the false passage).
 - You drink a lot of fluid (more than 2 -2 1/2 quarts or 2 liters) every day so you would need to catheterize very frequently).
 - You have a lot of pain when inserting or removing the catheter.
- You can use different types of catheters. Your doctor can help you decide which type of catheter is best for you. For example, the catheter might:
 - Have a slight curve at the tip. This is known as a Coudé (pronounced ku-DAY) catheter.
 - Have a bag attached at the end to catch the urine.
 - Be covered with lubricant to help it slide through your urethra.

Advantages:

- Intermittent catheterization simulates normal bladder filling which helps to maintain your normal bladder size
- You will not wear an internal or external catheter and leg bag all the time.

Disadvantages:

- You need to keep track of your fluid intake so that your bladder doesn't fill up too soon and get overstretched, especially while you are sleeping.
- You need to partially undress each time you use a catheter.
- You might find removing and inserting a catheter uncomfortable.
- If you are a woman, you might have trouble finding and passing your catheter into your urethra. You might cause some irritation or bleeding when passing a catheter into your bladder, especially if you are a man and have a very spastic urinary sphincter that tightens when you try to remove the catheter.
- You may need to take medication to keep your bladder from being overactive and causing urinary leakage.

Indwelling Catheterization

This option is used for ongoing protection from urinary retention or urinary incontinence. Indwelling catheterization uses a catheter and a urine collection bag that stays in place all the time. The catheter has a balloon at the tip of the catheter which sits in your bladder. Once the catheter is in your bladder, the balloon can be inflated to keep the catheter from falling out or deflating when it's time to change the catheter.

There are two types of indwelling catheters: urethral catheters and suprapubic (pronounced soo-prah-PEW Bik) catheters. Most urethral catheters that are kept in place by filling up a balloon. People might call your indwelling catheter a Foley catheter.

Type 1: Urethral Catheters

A urethral catheter is inserted through your urethra, by yourself, by a physician, nurse or a trained family member using a similar technique as intermittent catheterization. However, instead of removing the catheter when your bladder is empty, the indwelling catheter stays in your bladder and is held in place in your bladder by a small balloon at the end. A small tube connects the other end of the catheter into a collection bag. It is not a good idea to plug your catheter, especially if you do not have good sensation in your bladder. If your bladder fills up and gets over distended, it can cause serious problems such as a bladder or kidney infections or autonomic dysreflexia (if your injury is at T6 and above).

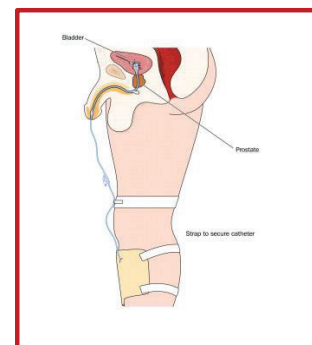

There are several types of collection bags:

- Smaller bags can be strapped to your leg so that you can move freely.
- Some larger bags don't have to be drained as often and are used when you are sleeping (called night bags).

- A modified bag can be strapped around your waist (called a belly bag) instead of your leg.

A collection bag must be emptied frequently:

- A collection bag must be emptied several times a day to keep it from getting too full. It is best to try to empty the bag when it gets about one half full.
- If the bag gets too full, pressure may build up in the bag and keep the urine from flowing down the tube. Instead, the urine will back up. This could cause your bladder to become over stretched and cause problems such as bleeding, bladder infection, or autonomic dysreflexia.

A urethral catheter stays in place all the time. About once a month, the catheter is removed and a new one is put in place. This may be done sooner if the catheter gets blocked from bladder stones or if there are other problems with the catheter's drainage.

Advantages

- You do not need to worry about inserting and removing the catheter into your bladder several times a day.
- You do not need to limit the amount of liquid you drink.
- You do not need to undress to use the catheter.

Disadvantages

- About 3 out of 10 people who use a urethral catheter get bladder stones, which are small hardened pieces that collect and can block your catheter and cause your bladder to get overstretched. This can cause leaking around the catheter, pain, a urinary tract infection, hematuria (blood in the urine), or autonomic dysreflexia.
- You might have discomfort or pain from the catheter, especially when inserting or replacing it.
- You might be uncomfortable wearing a urine collection bag and worry about it leaking.
- It can be difficult to keep the area around the catheter clean, especially for women.
- A constantly empty bladder can reduce the size of your bladder, making it less able to hold more urine.
- You may need to take medication to keep your bladder from being overactive and causing urinary leakage.
- There can be sexuality issues due to having a catheter in the urethra.
- There may be a slight increase in bladder infections with urethral catheters but not suprapubic catheters compared to other types of management.

Type 2: Indwelling Suprapubic Catheter

In order to insert an indwelling suprapubic catheter, a doctor first needs to make a small incision below the beltline. This is done under an anesthetic. He or she then inserts the catheter through the incision into the bladder. Urine drains out from the catheter and is then stored in a collection bag on the outside of your body. The collection bag is drained as needed, to keep the bag from getting overfilled. The catheter is changed on a monthly basis just like a urethral catheter.

After the catheter has been put in by a doctor, the incision heals and there is a small hole so that the old catheter can be removed and a new catheter can be inserted. It is important to measure the distance that the catheter is in your bladder by marking the catheter at the skin level before removing it and then putting the new catheter in the same distance in. As long as a catheter is in the hole, it stays open. Once the catheter is removed the hole will close in 1-3 days. There are no restrictions with bathing or showering with a suprapubic tube. One study showed that in women, there were fewer bladder infections with a suprapubic tube than any other type of bladder management.

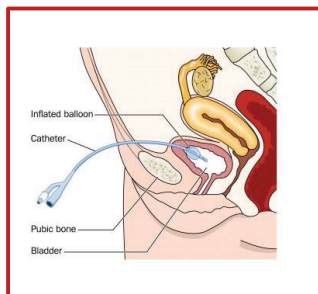

Advantages:

- Has all the advantages of a urethral catheter, and a suprapubic catheter also keeps you from feeling pain or discomfort from inserting and removing the catheter from your urethra.
- This catheter is easier to change than a urethral catheter. You do not need to lie down or undress to change the catheter.
- It is easy to keep the area around the catheter clean, and you are less likely to get an infection than with a urethral Foley catheter.
- It is preferable to a urethral catheter for sexuality reasons because the catheter is not in the urethra. If the suprapubic catheter becomes blocked or can't be removed, the urethra can sometimes act as a "pop off valve" releasing some of the urine, or the urethra can be used to pass a temporary urethral catheter.

Disadvantages:

- Like urethral catheters, there is an increased risk for developing bladder stones and a smaller bladder.
- You may need to take medication to keep your bladder from being overactive and causing urinary leakage.
- Same day surgery is needed to create the opening for the catheter.

Reflex Voiding

This option primarily is used by men with bladders that fill and squeeze on their own because a convenient way to capture urine is needed.

- This method usually uses an external condom catheter. These catheters fit like a condom around the penis and connect to a tube and collection bag. (There is no effective external collecting device for women.)
- This method requires a relaxed sphincter, and you might need help relaxing it. Methods of relaxing your sphincter include suprapubic bladder tapping (where you lightly tap the area over your bladder), medication, injections, and surgery.
- A man or a woman who uses a reflex voiding option might decide to have their bladder drain directly into a protective undergarment. Undergarments must be changed frequently to avoid the urine causing a skin rash.

Advantages:

- You do not need to limit your liquids.
- You do not need to undress to empty your bladder.

Disadvantages:

- Men need to wear an external condom catheter, and a leg bag or a protective undergarment to collect urine.
- Women must use a protective undergarment.
- Protective undergarments must be changed frequently.
- The skin around the penis might get irritated from the condom catheter being too tight.
- The external condom might twist or kink and fall off during voiding.
- If you have a “retractile” penis that pulls back into the abdomen, especially when you sit up, the condom catheter might not stay on.
- Additional treatment or medication might be needed to relax your sphincter, and these treatments could cause side effects.

Valsalva and Credé Voiding

This option is for people who have difficulty getting their bladder to squeeze. Credé (pronounced kre-DAY) is a method where you push inwards with a closed fist over your bladder to empty it. Valsalva (pronounced vahl-SAL-vah) is a method where you tighten your abdominal muscles and bear down to force urine from your bladder.

- The amount of bladder emptying depends on how much force you use to push urine from the bladder and how much your sphincter relaxes.
- While not recommended, people sometimes use crede or valsalva voiding in addition to their other type of bladder management. For example bearing down when they catheterize themselves to try to make their bladder empty a little quicker by forcing the urine flow through the catheter quicker or bearing down and forcing a little urine out of their bladder so they do not catheterize themselves as often.

Advantages:

- You do not need to use a catheter of any kind.

Disadvantages:

- The pushing or straining to empty your bladder can cause problems over time (such as hemorrhoids, hernias, and other medical problems).
- To catch the urine, you will need to undress and transfer onto a toilet, use a bed pan, or wear protective undergarments.
- It often takes a lot of effort and time to bear down in an attempt to empty your bladder.
- You may not be able to empty your bladder completely leading to complications such as UTI's and bladder stones.



Summary

- Following an SCI, maintaining healthy kidneys and a healthy bladder are important. There are many bladder management options.
- Your doctor can help you find the best option for your needs and lifestyle.
- Your doctor can also help you decide when an option is working well, or if a new option needs to be considered.

Reference

Consortium for Spinal Cord Medicine (2002). *Acute management of autonomic dysreflexia: individuals with spinal cord injury presenting to health-care facilities*. *J Spinal Cord Med.* 25, Suppl 1:S67-88.

Authorship

Bladder Management Options Following Spinal Cord Injury was developed by Todd A. Linsenmeyer, M.D., and Steven Kirshblum, M.D., in collaboration with the Model Systems Knowledge Translation Center.

Source: Our health information content is based on research evidence and/or professional consensus and has been reviewed and approved by an editorial team of experts from the Spinal Cord Injury Model Systems.

Disclaimer: This information is not meant to replace the advice of a medical professional. You should consult your health care provider regarding specific medical concerns or treatment. The contents of this fact sheet were developed under a grant from the National Institute on Disability, Independent Living, and Rehabilitation Research (NIDILRR grant number 90DP0012). The contents of this fact sheet do not necessarily represent the policy of Department of Health and Human Services, and you should not assume endorsement by the Federal Government.

Copyright © 2015 Model Systems Knowledge Translation Center (MSKTC). May be reproduced and distributed freely with appropriate attribution. Prior permission must be obtained for inclusion in fee-based materials.



Bone Loss After Spinal Cord Injury

November 2021

www.msktc.org/SCI/factsheets

SCI Factsheet

This factsheet explains how and why people with SCI lose bone, the risks of thinning bones, also known as osteoporosis, and what you can do to reduce your risk of bone loss.

The Spinal Cord Injury Model System is sponsored by the National Institute of Disability, Independent Living, and Rehabilitation Research, U.S. Department of Health and Human Services' Administration for Community Living. (See <http://www.msktc.org/sci/model-system-centers> for more information).

What you need to know

Low bone density occurs when the body loses too much bone. This causes weak bones that are easier to break. Bone loss can occur immediately after spinal cord injury (SCI) and can continue rapidly for several years after the injury. The medical term for low bone density is osteoporosis (pronounced ah-stee-oh-por-OH-sis).

How common is bone loss for people with SCI?

- Bone loss occurs in almost everyone with SCI. This starts immediately after injury and is most severe during the next 2 years. However, bone loss continues (at a slower rate) for the rest of your life. It is unknown why bone loss is so rapid and severe in the first 2 years after injury or why bone loss slows after this point.
- Bone loss occurs in all parts of the skeleton below the level of injury. The amount of bone loss generally depends on how much motor function still exists below the site of the injury. Less function is associated with greater bone loss. This means that people with very high-level injuries usually also have bone loss in their arms and wrists. However, broken bones happen most commonly just above or below the knee (lower third of the femur and upper third of the tibia).



Why does bone loss happen to people with SCI?

- One cause of bone loss is a lack of weight-bearing activity, such as walking, which may not be possible for many people with SCI. However, bone loss after SCI occurs at much greater rates than other situations where people are not able to do weight-bearing activities, such as extended bed rest or during space flight. Paralysis is likely the reason for this, although no one completely understands why paralysis leads to so much bone loss. Possible reasons include:
 - Weight-bearing activities like walking cause muscles to “pull” on bones, making them stronger. The lack of this “pull” results in less stimulation of bones, and can lead to bone loss.
 - Bone loss may be made worse by changes in hormones produced by the body, which can occur after SCI. Similar rates of bone loss also can be seen in older adults and women who have gone through menopause.
 - Bone loss may be made worse by the use of certain medications such as drugs to treat seizures (for example Dilantin or Phenytoin) or blood thinners (for example Warfarin or Coumadin, both commonly used in SCI).
 - The spinal cord injury disrupts signals traveling to and from the brain that may be needed to maintain bone mass.



What are the risks for bone fracture after SCI?

- Fracture risk increases with time since injury. About half of all people with SCI who have been injured for 10 years or more will have a bone fracture at some point after their injury.
- People with neurologically complete injuries—people without sensory or motor function below the level of injury—are at even greater risk for a fracture.



What activities can cause a bone fracture?

- Most fractures occur during wheelchair or bed transfers, usually by twisting or catching a leg or foot when moving from one location to another.
- Fractures can be caused by falls from a wheelchair or when a foot gets caught on the ground or on a front wheel while using a wheelchair.
- In more severe cases, even simple movements, such as stretching, dressing, or rolling over in bed, can cause a fracture. When bones break with little or no trauma, this is called a fragility fracture.
- Fractures also can occur when someone is helping you do an activity or holding you a certain way.

How will I know whether I have a fracture?

- Warning signs of a fracture include hearing a loud snap during ADL and mobility activities.
- There may also be redness and swelling near the site of a fracture and a low grade fever may develop.
- People with an injury above the T6 spinal cord level may experience autonomic (pronounced o-te-na-mik) dysreflexia (pronounced dis-re-FLEK-see-ah), a condition characterized by a sudden rise in blood pressure due to pain or discomfort that can result in a headache, flushed face, sweating, and a stuffy nose. This is not a complete list of the symptoms associated with autonomic dysreflexia—for more information see the MSKTC Factsheet on Autonomic Dysreflexia.

How are fractures treated?

- Fractures are usually treated with bed rest alone or a combination of bed rest and bracing of the affected limb to limit movement while the fracture heals. Surgery may be required in some cases. Fractures may not heal as well in people with SCI.



Can bone fractures cause other health problems?

- Medical complications can occur with fractures, including delayed healing of the fracture, pressure injuries (also known as pressure sores) from bracing and/or bed rest, bone infection of both fractures due to bacteria in the blood or nearby tissue, decreased range-of-motion, contractures (abnormal shortening of muscles), muscle spasticity and decreased mobility.
- Other complications include spasms, pain, autonomic dysreflexia, and abnormal build-up of calcium in the soft tissue around the fracture site.

What can I do to treat bone loss and minimize the risk of having a fracture?

There are many things that people with SCI can do to help reduce the amount of bone loss and the risk of fractures.

- Bone density (DXA) scans: Bone density can be measured using dual-energy x-ray absorptiometry (DXA) scans. DXA is useful for assessing fracture risk in people with SCI and seeing how well bones respond to treatment. Knowing the amount of bone loss is very important to clinical care providers who are considering prescribing activities that could potentially increase the risk of fracture.

- Calcium and Vitamin D: It is important for people with SCI to make sure they have plenty of calcium and vitamin D in their bodies. You may need to increase your intake of calcium in your diet or take calcium and vitamin D supplements. Ask your doctor about taking supplements and ask to have your vitamin D level checked through a simple blood test.
- Bisphosphonates (pronounced bis-FOS-fone-ayts): Bisphosphonates, such as zoledronic acid or alendronate, are used to treat bone loss in people with SCI. Drugs in this class slow down bone loss and may reduce fracture risk in the general population. We do not yet know if these drugs can help reduce fracture risk in people with SCI.
- More recently, a drug called Denosumab (deh·naa·suh·mab) has been shown to reduce bone loss in people SCI.
- Rehabilitation: Rehabilitation treatments that focus on stimulating paralyzed muscles to contract and encouraging weight-bearing can help. They can involve passive (tilt-table or standing frame) or active (walking, rowing, cycling) exercises, and electrical stimulation. However, passive rehabilitation exercises do not prevent dramatic bone loss after acute SCI in those who are more severely paralyzed and who cannot bear weight. DXA is recommended prior to initiating weight-bearing therapies.
- Self-care: It is important to be extra cautious when performing everyday activities, such as transfers and using your wheelchair, where you could catch a foot on a door, the ground, or the wheelchair itself. It is also important to watch for any signs of redness and swelling, particularly around the knee, since this may be a sign of a bone fracture. Let your doctor know right away if you think you may have a fracture so that you can have an X-ray to identify and appropriately treat a possible fracture.
- Other risk factors: The heavy use of alcohol may increase the risk of fracture in people with SCI. Alcohol may affect bone density, but drinking can also affect coordination or increase risk-taking behavior. Smoking associated with bone loss in the general population and smoking may also worsen bone loss in people with SCI.



Talk to your doctor about your risk of bone loss after SCI and how to best protect yourself from fractures.

Authorship

Bone Loss After Spinal Cord Injury was developed by Leslie R. Morse, D.O.; Trevor A. Dyson-Hudson, M.D.; and William A. Bauman, M.D., in collaboration with the Model Systems Knowledge Translation Center.

Source: The content in this factsheet is based on research and/or professional consensus. This content has been reviewed and approved by experts from the Spinal Cord Injury Model Systems (SCIMS), funded by the National Institute on Disability, Independent Living, and Rehabilitation Research (NIDILRR).

Disclaimer: This information is not meant to replace the advice of a medical professional. You should consult your health care provider regarding specific medical concerns or treatment. The contents of this factsheet were developed under grants from the National Institute on Disability, Independent Living, and Rehabilitation Research (NIDILRR grant numbers 90DP0012 and 90DP0082). NIDILRR is a Center within the Administration for Community Living (ACL), Department of Health and Human Services (HHS). The contents of this factsheet do not necessarily represent the policy of NIDILRR, ACL, HHS, and you should not assume endorsement by the federal government.

Copyright © 2021 Model Systems Knowledge Translation Center (MSKTC). May be reproduced and distributed freely with appropriate attribution. Prior permission must be obtained for inclusion in fee-based materials.



Bowel Function After Spinal Cord Injury

March 2015

www.msktc.org/sci/factsheets

SCI Fact Sheet

This fact sheet tells you about why a bowel program can improve your quality of life.

What you need to know

A spinal cord injury can lead to bowel problems:

- You may have problems moving waste through your colon (or large intestine).
- You may pass a stool when you don't want to, or a stool may be hard to pass.
- These problems can cause pain in your abdomen.
- When eating, you may feel full sooner than normal, or you may eat less than you usually do.
- Bowel problems can contribute to depression or anxiety. You may feel overly concerned about not being able to control bowel movements in public. You may not want to do things outside of your home.

A bowel program can help you to control bowel movements. Following a bowel program can help you to avoid other problems and perhaps bowel surgery.

Understanding your body

Your stomach and small intestine pull nutrients from the food you eat. Nutrients keep you strong and give you energy. The rest of the food becomes waste that your body doesn't need. Waste forms into a stool in your colon and rectum and leaves your body through the anus. The process of passing a stool through and out of your body is known as a "bowel movement." If you have a spinal cord injury, this process may be tough for you. For example, you may have a difficult time passing stools. This is called "constipation." Or you may not be able to control when you pass a stool. This is called "stool incontinence."

Spinal cord injuries may cause tightness (spasticity) or looseness (flaccidity) in the muscles of the rectum, sphincters, and pelvic floor. The degree of tightness or looseness may be related to the severity or completeness and level of your injury. If your injury is above level T11/T12, then the muscles of your sphincters and pelvic floor may be tight, which leads to constipation. If your injury is level T11/T12 or lower, then these muscles may be loose, which leads to stool incontinence. People with incomplete spinal cord injuries tend to have more muscle strength and sensation and therefore have fewer bowel problems than people with complete injuries.

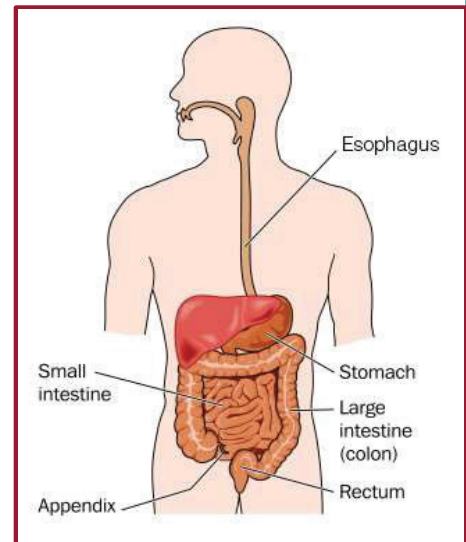

The Spinal Cord Injury Model System is sponsored by the National Institute on Disability and Rehabilitation Research, Office of Special Education and Rehabilitative Services, U.S. Department of Education. (See <http://www.msktc.org/sci/model-system-centers> for more information).

What is a bowel program?

A bowel program is a plan to retrain your body to have regular bowel movements. A doctor or nurse designs a bowel program specifically for you. Your health, bowel and personal history, physical examination are an important part of this review:

- The level and completeness of your spinal cord injury
- Description and pattern of bowel problems
- Past and present medical problems



- Intake of food and drink
- Physical activities
- Need for or availability of resources
- Home environment
- Lifestyle
- Preferences
- Gastrointestinal tests

The goals of a bowel program are:

- Passing a stool every day or every other day
- Preventing unplanned bowel movements
- Emptying your bowel around the same time of day (e.g., morning, afternoon, or evening)
- Passing medium or large stool (about 2 cups) every time you have a bowel movement
- Emptying all or most of your rectum each day
- Having stools that are soft, formed, and bulky
- Emptying your bowel completely within 30 minutes (or 60 minutes, at most) after eating

What is involved in a bowel program?

A bowel program includes four parts: timing, diet (including food and fluids), medicines, and techniques to help with bowel movements. The program isn't the same for everybody, because each person has different needs and responds differently to each part of the program.

Timing

A bowel program is best when done every day or every other day. A program involves:

- Eating a good diet and drinking plenty of fluids
- Using bowel medicines, as recommended by your doctor
- Practicing techniques that activate the reflex to empty your rectum
- Using methods to clean out stools

Diet and fluids

Eating a good diet and drinking plenty of fluids are important to bowel health:

- Natural fiber from fruits and vegetables increases the bulk of stool, making it easier to move through the colon. Doctors recommend 38 grams of fiber per day for men and 25 grams per day for women.
- When eating a diet high in fiber, you should drink plenty of fluids. Water is best. You may get constipated if you don't drink enough fluids. You should drink at least 2 or 3 quarts of fluids every day, unless told otherwise by your doctor.
- You should limit your intake of liquids with caffeine (e.g., coffee, tea, or energy drinks). These drinks actually remove fluids from your body.

Medicines

Your doctor may have you take one or more medicines, either orally or rectally:

- Stool softeners make stools soft and easy to move.
- Stimulant laxatives stimulate the colon to move stools.
- Bulking laxatives add shape and form to stools and prevent diarrhea (watery stools).
- Rectal laxatives help with rectal movement and emptying.

Some medicines may cause constipation. They may be ones that you're taking already to reduce pain or muscle spasms or to treat depression. You may benefit from minimizing your use of these medicines under the supervision of your physician:

- Medicines to reduce pain, such as hydrocodone, oxycodone, morphine, fentanyl, gabapentin, pregabalin, or carbamazepine
- Medicines to treat bladder spasms but slow down intestinal motility, such as oxybutynin or tolterodine
- Medicines to stop muscle spasms all over the body, such as lioresal, tizanidine, or diazepam
- Medicines to treat depression, such as cymbalta, sertraline, or citalopram

Techniques

You can do one or more techniques to help you have a bowel movement and empty your rectum. You can do these at home or with help from a caregiver or nursing aid.

- **Digital rectal stimulation:** Move your fingertip in a small, gentle, circular motion around the rectum/anus. This motion stimulates reflex of the rectum/anus. Be sure to cut your fingernails short to avoid trauma. Perform this technique for 20 seconds and repeat it every 5–10 minutes until the bowel program is completed and the rectum is empty.
- **Digital removal of stool:** Use your finger to remove stool from the rectum. This will speed up your ability to empty the rectum.
- **Enema:** Use a device to flush warm water into your rectum, which will help to empty it of stool. Examples of devices include the catheter enema or cone enema. If these simple enemas do not work, other home stool evacuation devices like the Peristeen enema and PIE (Pulsed Irrigation Evacuation) systems which have been approved by the U.S. Food and Drug Administration may help.

What if I can't do a bowel program or it doesn't work?

A serious injury may keep some people from carrying out a bowel program. For others, the program just may not work. Every person is different. Surgery may be a good option in a few cases, for example:

- If you can't achieve regular, complete bowel movements, which can lead to recurrent severe constipation (associated with frequent hospital admissions for stool loading and obstruction; chronic abdominal pain; prolonged [>1 hour], difficult bowel programs; or severe autonomic dysreflexia¹).
- If you have frequent stool incontinence (associated with pressure sores) or lack caregiver support, both of which may contribute to a poor quality of life and confinement in the home.

Other options include two kinds of surgery.

Colostomy

Surgeons attach the colon to the abdominal wall through a hole called a "stoma" (or opening). A bag is attached to the stoma. Stools pass into the bag instead of through the rectum. You or a caregiver empty and change the bag easily and regularly. (The end of colostomy is shown in the image.)

Most people who have the colostomy choose to have it permanently. The colostomy promotes good bowel movements and is easy to manage by yourself or by a caregiver. The procedure prevents stool incontinence and unplanned bowel movements. It also decreases mental stress so you can do more activities outside the home with family and friends.

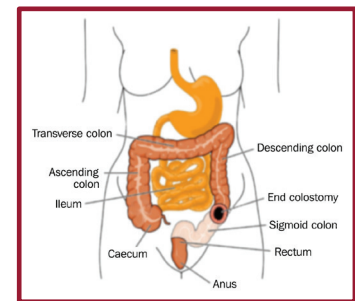

Antegrade Continence Enema

Surgeons open the abdominal wall to create a tract to either the first part of the colon (ascending colon) or the last part of the colon (descending colon/sigmoid) (See figure). You or a caregiver place an enema catheter through the stoma daily to flush the stool out of the colon with 500–1000mL of tap water. This process usually lasts from 30 to 60 minutes. Cleansing the colon daily and regularly prevents unplanned *bowel* movements and stool incontinence.



¹ Autonomic dysreflexia (pronounced aw-to-nom-ik dis-ree-FLEKS-ee-ah) is a serious condition in which dangerously high blood pressure is associated with a drop in heart rate in people with spinal cord injury at levels T6 and above. It may cause heavy sweating, flushing, headaches, and blurry vision. If left untreated, the condition may lead to stroke, bleeding in the eyes, swelling of the heart or lungs, and other severe health problems.

Why is maintaining bowel function so important?

Worsening and untreated bowel function can lead to other health problems:

- Partial paralysis of the stomach
- Chronic heartburn
- Gas pain
- Stomach or intestinal ulcers
- Hemorrhoids
- Abdominal discomfort, pain, or distension
- Nausea
- Bloating or fullness
- Change in weight (related to a poor diet or a decrease in appetite)
- Autonomic dysreflexia - This is a serious condition where a dangerous elevation in blood pressure is associated with a drop in heart rate in people with spinal cord injury at levels T6 and above. It may cause heavy sweating, flushing, headaches, and blurry vision. If left untreated, it may lead to stroke, bleeding in the eyes, swelling of the heart or lungs, and other severe health problems.
- Worsening pain and/or spasticity
- Decreased sense of well-being

These health problems can reduce your quality of life. But you may be able to avoid these problems by following a bowel program every day. Your doctor or nurse can help you and will check with you to see how you're doing. Ask questions, and let your health care professional know about any problems you're having.

Authorship

Bowel Function Problems After Spinal Cord Injury was developed by Gianna M. Rodriguez, M.D., in collaboration with the Model Systems Knowledge Translation Center

Disclaimer: This information is not meant to replace the advice of a medical professional. You should consult your health care provider regarding specific medical concerns or treatment. The contents of this fact sheet were developed under a grant from the National Institute on Disability, Independent Living, and Rehabilitation Research (NIDILRR grant number 90DP0012). The contents of this fact sheet do not necessarily represent the policy of Department of Health and Human Services, and you should not assume endorsement by the Federal Government.

Neither SCI Model Systems, MSKTC, or NIDILRR has examined, reviewed, or tested any product or device cited in the factsheet. None of the parties involved make endorsement, representation, or warranty as to any product or device contained in this factsheet.

Copyright © 2015 Model Systems Knowledge Translation Center (MSKTC). May be reproduced and distributed freely with appropriate attribution. Prior permission must be obtained for inclusion in fee-based materials.



Driving After Spinal Cord Injury

October 2015

www.msktc.org/sci/factsheets

SCI Fact Sheet

This fact sheet tells you about resources and steps you can take to help you return to driving after your spinal cord injury (SCI).

What you need to know

- You may be able to continue driving safely again, depending on how serious your injury is and how much function you have regained.
- If you can drive, you may need to buy a vehicle that suits your unique needs after the injury.
- Vehicles can be altered with special equipment called “assistive technology” to help you drive safely after your injury.
- Equipment can be expensive based on your function and the type of equipment necessary.
- You should take specific steps before you return to driving; there are resources to help you.

How do I know if I can drive a vehicle again?

The amount of time after your injury is a major factor in deciding whether and how you can return to driving. You may see many improvements in your abilities several weeks or months after your injury. With time, you may regain some functions that could make driving

possible. With time, the amount and cost of any needed special equipment may be reduced. You should look for these important signs that you are ready to drive again:

- You do not need narcotics to control your pain while you drive.
- You have good vision, or your vision can be corrected.
- You can control the muscle spasms and muscle tightening caused by the injury.

Your doctor can refer you to a driving rehabilitation specialist for a full evaluation to decide if you are ready and able to drive.

A full driving assessment will evaluate:

- Medical data/driving history/driving goals
- Vision
- Strength and range of motion
- Cognitive ability (if indicated)
- Ability to transfer
- Wheelchair or other mobility device loading
- Behind-the-wheel driving to try out equipment options

You might be able to drive safely with special assistive equipment for your vehicle. The equipment can be expensive. Obtaining a driving assessment may help minimize costs.

The Spinal Cord Injury Model System is sponsored by the National Institute of Disability, Independent Living, and Rehabilitation Research, U.S. Department of Health and Human Services' Administration for Community Living. (See <http://www.msktc.org/sci/model-system-centers> for more information).



How to find out what kind of assistive technology I will need.

Your doctor can refer you to a Certified Driver Rehabilitation Specialist (CDRS) near you who can do a driving evaluation for you. You can find a list of specialists and their locations at <http://www.aded.net/> or by calling ADED at 866.672.9466.

The CDRS can help you decide what special equipment you might need to drive a vehicle, and what type of vehicle would be best suited to your needs. The CDRS may also know about special funding to help you get the equipment you need. To be evaluated by a CDRS, you will most often need a referral from a doctor. If you live in an area where there is not a CDRS close by then we recommend you visit <http://www.nmeda.com/>, and use the dealer locator tool to find automotive mobility dealers closest to you. These dealers are specially trained to help with your driving equipment needs. They will know of professionals in your area that can best meet your needs. NMEDA's phone number is (866) 948-8341.

What kind of assistive technology is available?

There is assistive technology for many activities associated with driving; your choice will depend on what you need:

Getting in and out of a vehicle: Two of the main factors to consider in the return to driving after an SCI are vehicle entry and exit, and loading and unloading the mobility device if you use one.



An example of a wheelchair lift for a pickup truck.

Photo courtesy of Shepherd Center.

- You may be able to transfer from a wheelchair into the vehicle and then load the manual wheelchair on your own.
- If you cannot load your wheelchair, there are adaptive wheelchair loading devices like the one shown on the left.
- If you cannot safely and independently transfer from the wheelchair to the driver's seat, you may need a wheelchair-accessible vehicle that lets you drive or push your wheelchair into the vehicle.
- Some modified vehicles let you drive while sitting in the wheelchair.
- Whichever device you choose, the wheelchair must be secured while the vehicle is moving.

Operating the gas and brake controls: There are many different types of gas and brake controls; the most common are hand controls. Hand controls are available with many types of motion—push-pull, push-twist, push-rock, and push-right angle—so that drivers can use the one that suits them best. A CDRS can help you choose the best type for your injury or disability.

Controls can be mounted for the left or right hand. Pictured here is a right-floor-mounted mechanical hand control. Also a removable accelerator pedal block and steering wheel spinner knob can be seen. Photo courtesy of Shepherd Center.



Steering. Often a driver using hand controls will use only one hand for the steering wheel because the other hand is controlling the gas. A steering device like the one pictured here can help a driver steer efficiently with only one hand. The device can be placed on either side of the steering wheel, depending on which arm is strongest. The steering system can also be adapted so the driver can turn the wheel with less force using a smaller steering wheel, a separate electronic steering wheel, or even a foot-operated steering device.



Electronic Wheel to be used with right hand for steering.



Electronic Gas/Brake Lever used with left arm and Electronic Wheel used with right arm for steering.



A tri-pin steering device allows someone without finger function to turn the steering wheel.

Photos courtesy of Shepherd Center.

How will I pay for this equipment?

Assistive equipment can be expensive. An accessible vehicle can cost a few hundred more than a basic vehicle all the way to over \$100K based on your situation. Costs include equipment, installation, training, insurance, and upkeep. You might be able to get help to pay for these costs. Some options include:

- Your State's vocational rehabilitation (VR) program might help you buy, equip, and learn to use a vehicle. VR programs usually are for people who plan to return to school or work and who need costly high-tech equipment and/or a wheelchair-accessible vehicle.
- Most vehicle companies offer a rebate (about \$1,000) to qualified people who buy a new vehicle. These rebates usually limit what equipment can be purchased.
- The Crime Victims' Compensation Program might help if you are a victim of a crime (such as gunshot, drunk driver, violence). For more information, go to <http://victimsofcrime.org>, or call (202) 467-8700.
- Your State might have a trust fund that could help you. (For example, The Georgia Brain and Spinal Injury Trust Fund Commission helps Georgia residents with uninsured costs related to disability, including buying or modifying a vehicle. For more information, go to <http://www.ciclt.net/bsif/>.)
- HelpHOPELive helps organize community-based fundraising efforts to help cover the costs of uninsured medical expenses for people with tragic injuries. For more information, go to <http://www.helphopelive.org/about/>.
- The U.S. Department of Veterans Affairs, or VA, offers grants to veterans who become disabled due to disease or injury associated with their military service, or who become disabled as a result of therapy, rehabilitation, or medical treatments provided by the VA. For more information, go to <http://www.va.gov/>.

When is the best time for me to get started?

Timing is everything. Take your time and get all the facts. Your body might need time to adjust to the effects of your SCI. For example, your motor functions might be different 1 month after your SCI than even a few to several months later. We urge you to take the time you may need after your SCI to be evaluated by a CDRS. The CDRS will evaluate your skills and help you decide what vehicle and equipment you will need. If you use a wheelchair, it will be important to coordinate your new chair with any plans for driving and also to have your own chair available before you purchase a vehicle so that the vehicle choice can support you and your chair.

Remember, an adapted vehicle can be expensive. It is important to truly understand your needs before buying anything. Do not feel pressured to make quick decisions. Rushing into a purchase will almost always make an appropriate vehicle more expensive than when a full evaluation is made at the proper time. When a purchased vehicle cannot be adapted to meet your needs, money and time are wasted in selling it and then buying a well-matched vehicle.

Authorship

Driving after Spinal Cord Injury was developed by John Anschutz in collaboration with the Model Systems Knowledge Translation Center.

Source: Our health information content is based on research evidence and/or professional consensus and has been reviewed and approved by an editorial team of experts from the Spinal Cord Injury Model Systems.

Disclaimer: This information is not meant to replace the advice of a medical professional. You should consult your health care provider regarding specific medical concerns or treatment. The contents of this fact sheet were developed under a grant from the National Institute on Disability, Independent Living, and Rehabilitation Research (NIDILRR grant number 90DP0012). The contents of this fact sheet do not necessarily represent the policy of Department of Health and Human Services, and you should not assume endorsement by the Federal Government.

Copyright © 2015 Model Systems Knowledge Translation Center (MSKTC). May be reproduced and distributed freely with appropriate attribution. Prior permission must be obtained for inclusion in fee-based materials.



Exercise After Spinal Cord Injury

December 2016

www.msctc.org/sci/factsheets

SCI Fact Sheet

This fact sheet explains the important role that exercise and nutrition play after a spinal cord injury (SCI). It also describes some problem areas to watch for as you plan your exercise activities.

Summary

- ◆ If you have a spinal cord injury (SCI), you can and should be physically active.
- ◆ Your health will benefit from regular exercise after SCI.
- ◆ Your exercise program should include three parts: stretching, aerobic exercise, and strength training.
- ◆ Setting goals, recognizing potential barriers, being prepared, and learning about resources can help you have a successful exercise program.
- ◆ With so many options, you can find an exercise program that is right for you.

Introduction

People with SCI are more likely than the general population to have health problems related to weight gain, changes in cholesterol, and high blood sugar. People with SCI are also at higher risk of cardiovascular disease. Not being active may contribute largely to these problems.

Normal, everyday activities aren't enough to maintain cardiovascular fitness in people with SCI. Regular exercise can help to reduce the risk of health problems after SCI.

Importance of Regular Physical Activity

- ◆ Improves energy levels and ability to take part in activities
- ◆ Strengthens muscles
- ◆ Increases flexibility
- ◆ Improves mood
- ◆ Improves sleep
- ◆ Decreases pain
- ◆ Helps achieve and maintain a healthy weight
- ◆ Improves cholesterol
- ◆ Improves blood sugar
- ◆ Decreases the risk of heart disease

Because of these benefits, exercise is more than just fun—it's a form of medicine that can be a powerful tool for preventing and treating many health conditions.

Exercise Guidelines

Exercise should include stretching, aerobic exercise, and strength training. The Centers for Disease Control and Prevention (CDC) recommends three exercise options for adults:

- ◆ 150 minutes of moderate-intensity aerobic exercise every week and strength training 2 or more days per week. Strength training should focus on all possible major muscle groups.

OR

The Spinal Cord Injury Model System is sponsored by the National Institute of Disability, Independent Living, and Rehabilitation Research, U.S. Department of Health and Human Services' Administration for Community Living. (See <http://www.msctc.org/sci/model-system-centers> for more information).



- ◆ 75 minutes of vigorous-intensity aerobic exercise every week and strength training 2 or more days per week, to work all possible major muscle groups.

OR

- ◆ An equal mix of moderate- and vigorous-intensity aerobic exercise and strength training 2 or more days per week, to work all possible major muscle groups.

If you can't meet these guidelines, then exercise regularly based on your abilities. Avoiding inactivity is very important. Any amount of exercise is better than no exercise. Talk to a trainer, physical therapist, clinical exercise physiologist, or your doctor for more guidance. For more information, consult [CDC's Physical Activity Guidelines](http://www.cdc.gov/physicalactivity/everyone/guidelines/) (<http://www.cdc.gov/physicalactivity/everyone/guidelines/>).

Stretching

People with SCI should stretch regularly to prevent and treat stiff muscles and joints. A good flexibility program should stretch all major muscle groups. You should focus on your shoulders, hips, knees, and ankles, because these are common areas of tightness after SCI. Stretching can be done by yourself or with help from a trainer, therapist, aide, family member, or friend. You should stretch most days of the week. Some people with SCI even find it helpful to stretch many times per day. Start out by gently stretching each muscle group for at least 30 seconds. Repeat the stretch a second time, trying to go a little bit further. Also consider stretching before and after aerobic exercise and strength training.



Using an arm crank machine (ergometer) is one option for aerobic exercise that may be available at your local gym.

Aerobic Exercise

Aerobic exercise is particularly good for cardiovascular health. You can use the "talk test" to help gauge the intensity of your workout. The test is quite easy. If you are doing moderate-intensity exercise, you should be able to talk but not sing. If you are doing vigorous-intensity exercise, you shouldn't be able to say more than a few words without pausing to take a breath. Aerobic exercise should include three phases:

- ◆ Warm up by stretching and doing a light intensity activity. These slowly increase your heart rate and warm up your muscles.
- ◆ Exercise at a moderate or vigorous intensity (based on the talk test).
- ◆ Cool down by doing a light intensity activity. This slowly decreases your heart rate.

Strength Training

Strength training can be done on the same or different day as your aerobic exercise. But it doesn't count toward your time for aerobic exercise. Strength training should target major muscle groups that you can control. These muscles will differ for everyone depending on their SCI. To start, plan to perform each exercise at least 10 times (10 repetitions = 1 set). Take a short break. Repeat each set one or two times. To get the most out of strength training, perform to a point where it is hard for you to do another repetition without help.

Scheduling Exercise

It is best to exercise in routines of at least 30 minutes. But even as little as 10 minutes of physical activity at a time can provide health benefits. If possible, spread out your exercises throughout the week. The more time you spend exercising, the more health benefits you'll get!



Some individuals may choose to use free weights for strength training.

Options for Exercising

One of the great things about exercise is that so many options exist. Exercise can occur as part of your daily routine, such as walking or wheeling to work. Exercise can be done in your home (e.g., following an exercise video), at a gym, or in the community. You can exercise alone or with others.

Examples of stretching include:

- ◆ Yoga
- ◆ Laying on your stomach
- ◆ Using a standing frame
- ◆ Using exercise bands

Examples of aerobic exercise include:

- ◆ Hand cycling
- ◆ Rowing
- ◆ Circuit training
- ◆ Swimming
- ◆ Playing wheelchair basketball
- ◆ Pushing your wheelchair briskly (if you use a wheelchair)

Examples of strength training include:

- ◆ Weightlifting
- ◆ Using resistance bands
- ◆ Yoga

You might need special equipment to exercise, depending on your needs and how and where you choose to exercise, for example:

- ◆ Straps to improve positioning, stability, and balance while exercising
- ◆ Cuffs or wraps to help grip the exercise equipment
- ◆ Body weight support
- ◆ Electrical stimulation to help exercise muscles that are below the level of the injury

Where to Start

1. Think about your goals for physical activity. This will be different for everyone. Here are some examples:
 - ◆ Become physically fit and improve your heart health
 - ◆ Lose weight and use less medicine
 - ◆ Be active and enjoy the outdoors
 - ◆ Make friends at a gym or exercise class

Choose goals that you can attain. But the goals should be challenging too—think big! Write down your goals, and refer to them a lot. Use your goals to motivate and to remind you why you started exercising.



When using exercise equipment, a chest strap can be helpful to provide trunk stabilization.



Equipment such as kettle bells can be used for strength training in individuals with decreased hand function.

2. Think about a location that is best for you to exercise and keep an exercise routine. You should consider your level of mobility, options for transportation, whether you prefer to exercise alone or in a group, and accessibility of local fitness centers. There is no right or wrong place. Focus on a setting that will give you the best chance for success. For example, if you know that you'll need support and encouragement from other people, then a home-based exercise program is probably not the right choice for you. Ask yourself the following questions:
 - ◆ Do I want to exercise at home or at a fitness center? Inside or outside?
 - ◆ Do I want to exercise by myself or with others?
 - ◆ What equipment will I need to exercise? Where can I get it?
 - ◆ Am I interested in fitness classes? If so, when and where are they offered?
 - ◆ What options do I have for transportation?
 - ◆ Will I be able to access the local fitness center? Are the lockers, showers, and restrooms accessible?
 - ◆ When is the fitness center open? Do these hours work for me?
 - ◆ Will I receive assistance and expert help?
 - ◆ What fitness plan can I afford?
3. Learn more about the resources in your community. Talk to your doctor or physical therapist about your goal to exercise regularly. Do they have any suggestions? Talk to other people with SCI in your community. Where do they exercise? What resources do they find helpful? If you live in or near a city, look for a hospital or rehab center in which staff work with people with SCI. They may know of local, accessible exercise programs and recreation resources. Check out places like the YMCA. Are its facilities accessible? Does it have trainers who know how to work with people with SCI? The first few places you contact may not be right for you. Don't give up.
4. Finally, choose an engaging activity—one that excites you. And stick with it!

Ready? Set? What's Next?

Go easy as you start to exercise. If you're not used to exercising, give your body time to adapt to being active. If you have not exercised recently, you should first get comfortable doing moderate-intensity activities before adding more vigorous-intensity activities. Don't give up if you don't like the activity that you chose. With so many options, you can always choose another activity.

Eat Right

Make the most of your exercise program by also eating right. Like exercise, good nutrition can help to manage blood pressure and cholesterol and decrease your risk of diabetes and heart disease. Eating right promotes a strong immune system and helps to prevent skin breakdown. A good diet will also give you the energy you need to exercise:

- ◆ Eat breakfast.
- ◆ Eat small portion sizes.
- ◆ Eat five servings of fruits and vegetables per day.
- ◆ Eat lean protein, such as chicken and fish, instead of red meat.
- ◆ Limit eating processed foods and foods high in fat.
- ◆ Choose healthy snacks between meals.
- ◆ Stay hydrated.

For more information about nutrition and eating right, consult [Weight Management Following Spinal Cord Injury](http://images.main.uab.edu/spinalcord/SCI%20Infosheets%20in%20PDF/Weight%20Management%20following%20SCI.pdf) (<http://images.main.uab.edu/spinalcord/SCI%20Infosheets%20in%20PDF/Weight%20Management%20following%20SCI.pdf>).



Troubleshooting

Overcome Barriers to Getting Involved

Even if you really want to exercise, some barriers may make starting more difficult than you might think, for example:

- ◆ Being unsure of what to do
- ◆ Being unsure of where to go
- ◆ Financial barriers
- ◆ Finding and scheduling reliable transportation
- ◆ Fear of stigma and negative attitudes
- ◆ Health-related concerns, such as skin breakdown, shoulder pain, autonomic dysreflexia, or changes to your bowel and bladder management.

These problems are common. But know that you aren't alone. Talk to your trainer, therapist, doctor, or friends to help find the best solution. Every person is different. Every solution is unique. Don't give up!

Stay Committed

Here are some tips to stay on track with your exercise program:

- ◆ Remember your goals.
- ◆ Plan out your activities weekly. Have reasonable expectations.
- ◆ Exercise at the same time of day so it becomes part of your regular routine.
- ◆ Keep track of your progress by writing your exercises in a calendar or journal.
- ◆ Be flexible. If something comes up and you can't exercise as planned, work physical activity into your day in other ways.
- ◆ Make exercise fun. Try working out with other people, adding some variety to your exercise routine, or listening to music or audiobooks.
- ◆ Celebrate success!

Be Aware of Potential Health Problems

Exercise should be fun and safe. But you should always be on the lookout for potential problems.

Skin Breakdown

Many people with SCI have changes or lack feeling below the level of the injury. For example, you may not be able to feel a new cut on your skin. Exercise may increase pressure or friction on the skin. This can increase the risk of skin breakdown.

What to do:

- ◆ Pay special attention to the surface on which you sit or lay.
- ◆ Use your wheelchair cushion whenever possible, especially on hard surfaces.
- ◆ Secure yourself to the exercise surface to avoid increased friction.
- ◆ Perform weight shifts every 30 minutes for 2 minutes.
- ◆ Check your skin daily.
- ◆ Tell your doctor if you have an area of skin that gets red regularly when exercising or gets red and doesn't go away.



Temperature Regulation

People with SCI may not be able to keep a safe body temperature when exercising. Sweating normally cools you down during exercise. If you don't sweat below the level of the injury, you can overheat quickly. Overheating can even happen when it is cool outside. On the other hand, you may not be able to stay warm when you exercise in the cold.

What to do:

- ◆ Drink water or fluids before, during, and after exercise.
- ◆ Wear clothing in layers so you can adjust as needed.
- ◆ In warm weather, use a cold towel or spray bottle to help you stay cool.
- ◆ In cold weather, make sure that your arms, hands, feet, and legs don't get too cold.

Orthostatic Hypotension

Some people with SCI experience a drop in blood pressure when in an upright position. This is known as orthostatic hypotension. It tends to occur most often when changing from a lying position to sitting or from a sitting position to standing. It can also occur when sitting or standing for a long period of time.

People with a SCI level above T6 have an increased risk of orthostatic hypotension. Common symptoms include lightheadedness, dizziness, and nausea.

What to do:

- ◆ If the exercise calls for sitting or standing, make sure you can first tolerate that position.
- ◆ Avoid quickly moving from lying to sitting or from sitting to standing.
- ◆ Stay hydrated.
- ◆ If you develop symptoms, try using compression stockings and an abdominal binder when exercising.
- ◆ If you have symptoms of orthostatic hypotension, lay on your back with your feet elevated until your symptoms go away.
- ◆ Talk to your doctor if your symptoms make it hard for you to exercise.

Autonomic Dysreflexia

After SCI, your body may change the way it responds to pain, discomfort, or irritation below the level of the injury. Even if you can't feel below the level of the injury, your body can find a way to tell you that something is wrong. One way may be through the quick onset of very high blood pressure. This is known as autonomic dysreflexia (AD).

AD can be deadly if not treated. People with a SCI level above T6 are at risk of AD. Common symptoms include headache, sweating, nausea, goosebumps, and a stuffy nose. Anything that would cause pain below the level of the injury can cause AD. Examples include full bladder or leg bag, constipation, tight clothes, pressure sore, blister, ingrown toenail, urinary tract infection, or broken bone.

What to do:

- ◆ Learn about and notice the symptoms of AD. Check out the MSKTC factsheet on AD at <http://www.msktc.org/sci/factsheets>.
- ◆ If you have symptoms while exercising, stop right away and try to determine and reverse the cause:
 - Sit up.
 - Loosen any tight clothing.
 - Check your bladder (is your leg bag full, is your catheter draining, or do you need to catheterize).
 - Move off of any pressure sores or high pressure areas.
 - Seek medical help quickly if your symptoms don't go away.



Overuse Injuries

People with SCI are at risk for overuse injuries. These types of injuries occur when you use the same muscles and movements for both everyday activities and exercise. Shoulder pain is the most common overuse injury in people with SCI.

What to do:

- ◆ If possible, consider alternatives to wheelchair pushing for exercise.
- ◆ Practice good body mechanics when exercising (and with everyday activities).
- ◆ Balance routines of stretching, aerobic exercise, and strength training. Remember, a good exercise program includes all three parts.
- ◆ Talk to your trainer, therapist, or doctor about new or increasing pain. They may want to alter your exercise program and daily activities or develop a treatment plan.

Bone Loss and Broken Bones

People with SCI who don't walk regularly are at risk of weaker bones or bone loss below the level of the injury. This bone loss increases the risk for broken bones—even after only mild trauma, such as twisting your leg or falling from your wheelchair. Because of changes in sensation in some people after SCI, you may not even be aware of a broken bone.

What to do:

- ◆ Talk to your doctor about your risk for bone loss and broken bones before starting a new exercise program.
- ◆ Talk to your doctor about whether or not any medications or supplements may be helpful in optimizing your bone health.
- ◆ Seek medical attention if you notice any new pain, swelling, or redness or increased AD

Additional Resources

The [CDC's Physical Activity Guidelines](http://www.cdc.gov/physicalactivity/everyone/guidelines/) (<http://www.cdc.gov/physicalactivity/everyone/guidelines/>) includes definitions for exercise.

American Congress of Rehabilitation Medicine has created a guide with exercise [recommendations and considerations for persons with spinal cord injury](http://www.archives-pmr.org/article/S0003-9993(15)00118-5/pdf) ([http://www.archives-pmr.org/article/S0003-9993\(15\)00118-5/pdf](http://www.archives-pmr.org/article/S0003-9993(15)00118-5/pdf)).

The [National Center on Health, Physical Activity and Disability](http://www.nchpad.org) (<http://www.nchpad.org>) offers a lot of information about exercise, nutrition, weight loss, and advocacy initiatives for people with disabilities. For example, "[14 Weeks to a Healthier You](#)" can help you set up an exercise and nutrition program that's right for you.

Authorship

Exercise After Spinal Cord Injury was developed by Cheri Blauwet, M.D., and Jayne Donovan, M.D., in collaboration with the National Center on Health, Physical Activity and Disability (NCHPAD) and the Model Systems Knowledge Translation Center. Credit for these images goes to Lakeshore Foundation and NCHPAD.

Source: Content is based on research and/or professional consensus. Editorial experts from the Spinal Cord Injury Model Systems reviewed and approved this content.

Disclaimer: The content of this factsheet does not replace the advice of a medical professional. You should consult a health care provider about specific medical concerns or treatment. This fact sheet was developed under a grant from the National Institute on Disability, Independent Living, and Rehabilitation Research (NIDILRR grant number 90DP0082). This content may not represent the policy of the U.S. Department of Health and Human Services. The federal government may not endorse this content.

Copyright © 2016 Model Systems Knowledge Translation Center (MSKTC). You can freely reproduce and distribute this content. Include proper attribution. But you must get permission before using this content in fee-based products.



Maintenance Guide for Users of Manual and Power Wheelchairs

March 2018

www.msktc.org/sci/factsheets

SCI Fact Sheet

This fact sheet explains the importance of wheelchair maintenance. It identifies when to inspect specific parts and functions and signs of problems to look for.

Introduction

Wheelchair breakdowns can injure wheelchair users and limit mobility and social participation. Poor wheelchair maintenance increases the risk of wheelchair breakdowns and personal injury or death, and increases the costs of medical care. The number of users injured from wheelchair breakdowns doubled from 1991 to 2016.

According to a 2016 study, up to 18% of wheelchair users experience a wheelchair-related injury each year. Furthermore, 44–57% reported at least one wheelchair breakdown in the past 6 months. Of these, 20–30% of users stated that because of the breakdown, they missed work and appointments, were stranded at home or away from home, or were injured.¹

Importance of maintaining a wheelchair

If you use a wheelchair (or know somebody who does), then you should develop the skills and knowledge to perform basic wheelchair maintenance. Wheelchair maintenance can reduce wheelchair breakdowns and related consequences, as well as costs for repairs and replacement.

If you are able to, you should regularly inspect all of the components on the wheelchair to make sure they work right. If you need assistance, consider asking a caregiver, friend, or family member for help with checking your wheelchair. If there is a problem, you should either fix it or take the wheelchair to a maintenance expert.

When to perform maintenance and what to look for

You'll need tools to perform basic maintenance on your wheelchair. Helpful tools might include screwdrivers, Allen wrenches, combination wrenches, lubricant, a tire lever, a tire pump, a tire patch kit, a bucket with water, and a cloth. When transferring out of the wheelchair to do maintenance, always sit on a stable and protected surface.

The following sections provide details about maintaining manual and power wheelchairs. The sections identify when to inspect specific parts and functions and what signs of problems to look for.

Do not try to fix or replace any wheelchair part if you don't feel comfortable doing it. Make plans to have the wheelchair serviced completely by a wheelchair maintenance expert once a year. A wheelchair maintenance expert may include your wheelchair vendor or manufacturer, an occupational or physical therapist, or another employee at a wheelchair seating clinic.

The Spinal Cord Injury Model System is sponsored by the National Institute of Disability, Independent Living, and Rehabilitation Research; U.S. Department of Health and Human Services; Administration for Community Living. (See <http://www.msktc.org/sci/model-system-centers> for more information).

Areas for Maintenance

Click on the links below to jump to the associated section in this document.

Manual Wheelchairs

[Rear wheels](#)
[Cushion](#)
[Frame](#)

[Caster wheels](#)
[Supports](#)

Power Wheelchairs

[Rear wheels](#)
[Cushion](#)
[Frame](#)

[Caster wheels](#)
[Supports](#)
[Electrical system](#)

¹ Toro, M. L., Worobey, L., Boninger, M. L., Cooper, R. A., & Pearlman J. (2016). Type and frequency of reported wheelchair repairs and related adverse consequences among people with spinal cord injury. *Archives of Physical Medicine and Rehabilitation*, 97(10):1753–1760. doi: 10.1016/j.apmr.2016.03.032



Manual wheelchairs: Areas for maintenance

Inspect every part of the wheelchair. Make sure that all nuts and bolts are tight, but not too tight.

Rear wheels

Timing	Part/Area	What to Do
Weekly	Tire pressure (for pneumatic tires)	<ul style="list-style-type: none"> Check the pressure by pressing down firmly on the tire with your thumb. If you can press down more than 5 mm (roughly the thickness of three pennies stacked together), then the tire needs to be pumped up with air. Use a bike pump to add air to the tire. Not all tires are the same; the appropriate pressure should be listed on your tire. If you find that your tire is not holding air, the inner tube may have a hole and you should patch it or replace it. If the tire lacks sufficient pressure, the wheelchair will be difficult to maneuver, propelling the wheelchair will take more energy, it will stress the user's shoulders more, and increase risk for shoulder pain.
Monthly	Tires	<ul style="list-style-type: none"> Inspect the rear tires for wear, cracks, bulges, looseness, damage, and flat spots. Problems can occur when tread becomes worn, cracked, or loose, or when the sidewalls begin to bulge out when pumped with air. Worn out tires can make the wheelchair harder to propel. If you find issues with the tires, contact a maintenance expert to replace them. In some cases, a bicycle shop may be able to help with repairs.
Monthly	Bearings	<ul style="list-style-type: none"> Lift one side of the wheelchair off the ground. Spin the wheel, and let it rotate to a stop. If the wheel slows and stops quickly when spun, then the nut and bolt holding the bearing could be too tight. If the wheel slows and rotates backwards slightly when spun, then the bearing is not being compressed and could be too loose. Repeat the same procedure with the other wheel. Bearings will wear out during normal use. Noise can be the first sign that a bearing is failing and can include a knocking sound or a squeaky, squealing moan. If you find an issue with the bearing, it should be replaced.
Monthly	Spokes	<ul style="list-style-type: none"> Gently squeeze two pairs of spokes together all the way around the wheel. If a spoke "gives," it may be too loose. Spokes have a domino effect; if you find one loose one, others will follow. Loose spokes can make the wheelchair harder to propel, or cause the wheel to collapse. If spoke tension is unequal, you may hear a faint, metallic, snapping sound as you move. A bicycle store or shop can be a useful resource to get spokes tightened for pneumatic tires. Check to make sure that spokes aren't bent.
Monthly	Alignment	<ul style="list-style-type: none"> Check wheel alignment by rolling through a puddle of water and allowing the wheelchair to coast. Examine the tracks left on the ground by the wet tires. The tracks should maintain a steady path. If they don't, contact a maintenance expert. Misalignment can lead to the user having to push more to travel straight, wasting energy.
Monthly	Axle (fixed and quick-release)	<ul style="list-style-type: none"> Hold the wheel away from the hub and wiggle it in all directions. For a fixed axle, there should not be any play in the wheel. For a quick-release axle, some play is acceptable. Check that the quick-release mechanism works correctly. The axles should slide smoothly through the wheel housing and then click and latch into place. Contact a maintenance expert if the wheels are not securely latching as the wheel can come off, which can lead to an accident.
Monthly	Folding and moving parts	<ul style="list-style-type: none"> Clean, dry, and lubricate all moving parts with either oil or a Teflon-based spray. Pay close attention to all folding parts, the rear axle, the front casters, and any exposed hinges. Lubrication is important because increased friction between moving parts can accelerate wear.
Monthly	Wheel locks	<ul style="list-style-type: none"> Make sure the wheel locks are secured tightly to the frame. Apply the lock and check that it holds the tires firmly in place. You should be able to set the wheel locks easily. The wheel locks should not get in the way of the tires while rolling. Ensuring that wheel locks are working properly is important as they act as parking brakes and help users when transferring to other surfaces, or when users want to remain in a particular spot.
Monthly	Handrim	<ul style="list-style-type: none"> While propelling, make sure the handrim is firm (not loose). The surface of the handrim should be smooth (not rough). Cracks can cause harm to the user and a loose handrim can make it more difficult for the user to grasp the handrim, which may cause the user's hand to fall off, which could result in a loss of balance and increase risk for falling.



Caster wheels

Timing	Part/Area	What to Do
Monthly	Wheels	<ul style="list-style-type: none"> Inspect caster wheels for wear, cracks, looseness, bulges, and tears. Worn out caster wheels can make the wheelchair harder to propel. Check for caster flutter. Flutter is the shimmy or rapid vibration of the caster wheels. Make sure the wheels touch the floor evenly when on a flat surface and that the caster forks (which connect the caster wheel to the frame) are aligned vertically. If either of these conditions are present, it can decrease the wheelchair's stability and performance.
Monthly	Axle bearings	<ul style="list-style-type: none"> Remove dirt, lint, and hair from the axle bearings with scissors, tweezers, a toothbrush, or pliers. These substances can wear out the bearing and make the wheelchair hard to maneuver.
Monthly	Anti-tip mechanism	<ul style="list-style-type: none"> Inspect the pins to make sure that they work and can be put on and off. Make sure the rollers aren't broken. Issues with the anti-tip mechanism can affect its ability to prevent tipping accidents.

Cushion

Timing	Part/Area	What to Do
Weekly	Cushion and cover (inspect)	<ul style="list-style-type: none"> Remove the cover so you can inspect it as well as the cushion. The cover protects the cushion. Fix tears or holes in the cover and check for flaking in the liner. Make sure the zipper works right. A damaged cover or zipper might create a wrinkled sitting surface. If you have an air cushion, keep it properly inflated and make sure the valve is in good condition and doesn't leak. If you suspect that there is a leak, remove the cover, submerge the cushion in water, and look for bubbles. If it is an air filled cushion, you may be able to patch the leak. If you have a gel cushion, knead the gel daily so it moves under bony prominences. Inspect the gel to make sure it's not hard and there are no leaks. If you find a leak, contact your wheelchair maintenance expert immediately to have it repaired or replaced. If you have a foam cushion, inspect the foam to make sure it's intact and not deteriorating and chipping. When you press it, it should bounce back. If you have a solid seat insert, check for cracks and make sure the cushion has the right shape and contour. After inspecting the cushion, place it back on the wheelchair properly. You may want to have a back-up cushion to use while the main cushion is being cleaned. Cushions are an important part of the wheelchair. But cushions don't last as long as the frame. The interaction between the cushion and the user's body determines the user's comfort, function, and safety. If you find a problem, you should contact a wheelchair maintenance expert immediately to get the cushion replaced. Deterioration in the cushion can increase the risk of the user developing a pressure sore.
Monthly	Cushion and cover (clean)	<ul style="list-style-type: none"> Wipe down the cushion with a clean, damp cloth and soap. You can put the cover in the washing machine but NOT in the dryer as the fabric may shrink and not fit the cushion anymore. Instead, dry the cushion on a towel in the shade. Avoid direct sunlight. Dirt on the cushion can cause skin breakdown and leave an odor on both the wheelchair and cushion. You may want to have a back-up cushion to use while the main cushion is being cleaned.

Supports

Timing	Part/Area	What to Do
Monthly	Foot supports	<ul style="list-style-type: none"> The foot supports are often the first part of the wheelchair to encounter an obstacle. This is because they are used to open doors, they act as bumpers, and they scrape along the ground). Make sure that the foot supports are intact and tightened, can be released (if originally designed to do so) and put back into place with ease, and can be latched easily. Inspect the swing-away foot support. Look for wear on the pin, bolt, and bushing. Inspect the heel loop, and if it is worn and flat or broken, contact a wheelchair maintenance expert immediately to replace the strap. The pin holding the strap can injure the user's foot.



Supports (continued)

Timing	Part/Area	What to Do
Monthly	Arm supports	<ul style="list-style-type: none"> The main purpose of the arm supports is to provide good resting posture for the arms. In addition, arm supports provide convenient handles when the rider leans to one side or the other. They are also helpful when a user attempts to reach higher places and help some users with transfers. Make sure that the arm supports are intact and tightened, can be released (if originally designed to do so) and put back into place with ease, and can be latched easily. Get rid of any sharp edges that could cause harm.
Monthly	Back support	<ul style="list-style-type: none"> The back support provides comfort and postural support while sitting. Make sure the surface of the back support is intact. Ensure that the hardware for the back support is attached properly to the posts and doesn't rattle.
Monthly	All supports (clean)	<ul style="list-style-type: none"> Wipe down all supports with a clean, damp cloth and soap. Cleaning the wheelchair may stop metal parts from rusting and may stop damage caused by dirt scraping against moving parts.
Monthly	Upholstery (including stitching and rivets)	<ul style="list-style-type: none"> Inspect upholstery for wear and tears. Make sure that fabric is not stretched out and that metal parts aren't sticking out. Loose upholstery can lead to skeletal deformities. Clean upholstery with a clean, damp cloth with or without soap.
Monthly	Clothing guard	<ul style="list-style-type: none"> Clothing guards provide a barrier between the wheelchair user and the wheel. They help to protect the user's clothing from the wheels. Tighten nuts and bolts as needed.

Frame

Timing	Part/Area	What to Do
Monthly	Welds	<ul style="list-style-type: none"> All common wheelchair frames center around tubular construction. The tubing can either be welded together or bolted together using lugs. Inspect the frame, weld points, and all holes and bends to confirm that they're intact. Look for cracks and fractures. If these aren't fixed, the wheelchair can completely fail, which may lead to catastrophic injury or death.
Monthly	Cross-brace	<ul style="list-style-type: none"> The cross-brace is a hinged, x-shaped support between the two side frames. It allows the wheelchair to fold. Move the cross-brace to make sure it works correctly. It should open and fold easily. Problems with the cross-brace mechanism may cause the wheelchair to collapse and lead to injury to the user or interfere with proper folding for storage.
Monthly	Suspension	<ul style="list-style-type: none"> Make sure the paint in the springs is intact and has no cracks. Inspect the damper to make sure it's not leaking lubricant. Suspension elements decrease shock and vibration and make for a smoother ride. The suspension should be inspected by a wheelchair maintenance expert following a significant weight change (gain or loss). Be aware that when going over obstacles—for example, a speed bump—the wheelchair should not make noises. If it does, it may not be safe. At least three wheels should touch the ground at all times.
Monthly	Whole frame	<ul style="list-style-type: none"> Wipe down the entire frame with a clean, damp cloth and soap. Cleaning the wheelchair may stop metal parts from rusting and may stop damage caused by dirt scraping against moving parts.

Power wheelchairs: Areas for maintenance

Before doing any maintenance, turn the power switch to OFF and remove the charger cords. Inspect every part of the wheelchair. Make sure that the nuts and bolts are tight, but not too tight.

Rear wheels

Timing	Part/Area	What to Do
Weekly	Tire pressure (for pneumatic tires)	<ul style="list-style-type: none"> Most power wheelchair tires are solid; however, some are pneumatic. Check the pressure by pressing down firmly on the tire with your thumb. If you can press down more than 5 mm (roughly the thickness of three pennies stacked together), then the tire needs to be pumped up with air. Use a bike pump to add air to the tire.
Monthly	Tires	<ul style="list-style-type: none"> Inspect the rear tires for wear, cracks, bulges, looseness, damage, and flat spots. Problems can occur when tread becomes worn, cracked, or loose, or when the sidewalls begin to bulge out when pumped with air. When tire tread depth is low, it can easily lead to power chair slippage, making braking distances longer. Wear can also negatively affect the wheelchair's maneuverability and stability. Contact a maintenance expert to replace the tires.

Caster wheels

Timing	Part/Area	What to Do
Monthly	Wheels	<ul style="list-style-type: none"> Inspect caster wheels for wear, cracks, looseness, bulges, and tears. Check for caster flutter. Flutter is the shimmy or rapid vibration of the caster wheels. Excessive flutter can cause the wheelchair to move in an unwanted direction. This might cause a collision and injure the user. Contact a wheelchair maintenance expert to get caster wheels repaired.
Monthly	Axle bearings	<ul style="list-style-type: none"> Remove dirt, lint, and hair from the axle bearings with scissors, tweezers, a toothbrush, or pliers. Dirt, lint, or hair buildup on the axles and casters can eventually cause premature wear. In particular, hair can twist around the bearings and cause breakage. Bearings will wear out on a caster wheel during normal use. Problems in the bearings are identified when noises like clicking or grinding are present. Bearings should be replaced before they fail.
Monthly	Anti-tip mechanism	<ul style="list-style-type: none"> Check that the anti-tip wheels aren't loose and do not squeak or drag. If wheels are loose, use an Allen wrench or open-end box-end wrench to tighten any screws until snug. Make sure the wheels aren't cracked or worn out. When anti-tip casters are in use and properly adjusted, they should help prevent wheelchair tipping incidents. However, anti-tip casters do not prevent all tipping incidents from occurring. Always make sure to exercise caution. Contact a wheelchair maintenance expert to get the anti-tip mechanism replaced.

Cushion

Timing	Part/Area	What to Do
Weekly	Cushion and cover (inspect)	<ul style="list-style-type: none"> Remove the cover so you can inspect it and the cushion. The cover protects the cushion. Fix tears or holes in the cover and check for flaking in the liner. Make sure the zipper works correctly. A damaged cover or zipper might create a wrinkled sitting surface. If you have an air cushion, keep it properly inflated and make sure the valve is in good condition and doesn't leak. If you suspect that there is a leak, remove the cover, submerge the cushion in water, and look for bubbles. If it is an air filled cushion, you may be able to patch the leak. If you have a gel cushion, knead the gel daily so it moves under bony prominences. Inspect the gel to make sure it's not hard and there are no leaks. If you have a foam cushion, inspect the foam to make sure it's intact and not deteriorating and chipping. When you press it, it should bounce back. If you have a solid seat insert, check for cracks and make sure the cushion has the right shape and contour. Be aware of the direction of the cushion. After inspecting it, place the cushion back on the wheelchair properly. You may want to have a back-up cushion to use while the main cushion is being cleaned. Cushions are an important component of the wheelchair. But cushions do not last as long as the frame. The interaction between the cushion and the user's body determines the user's comfort, function, and clinical safety. If you find a problem, contact a wheelchair maintenance expert immediately to get the cushion replaced. Deterioration in the cushion can increase the risk of the user developing a pressure sore.
Monthly	Cushion and cover (clean)	<ul style="list-style-type: none"> Wipe down the cushion with a clean, damp cloth and soap. You can put the cover in the washing machine but NOT in the dryer as the fabric may shrink and not fit the cushion anymore. Instead, dry the cushion on a towel in the shade. Avoid direct sunlight. Dirt on the cushion can cause skin breakdown and leave an odor on both the wheelchair and cushion.

Supports

Timing	Part/Area	What to Do
Monthly	Foot supports	<ul style="list-style-type: none"> Make sure that the foot supports are intact and tightened, can be released (if originally designed to do so) and put back into place with ease, and can be latched easily. Inspect the swing-away foot support. Look for wear on the pin, bolt, and bushing.
Monthly	Arm supports	<ul style="list-style-type: none"> Make sure that the arm supports are intact and tightened, can be released (if originally designed to do so) and put back into place with ease, and can be latched easily. Get rid of any sharp edges that could cause harm.
Monthly	Back support	<ul style="list-style-type: none"> Make sure the surface of the back support is intact. Ensure that the back support hardware is attached properly to the posts and doesn't rattle.
Monthly	Other supports	<ul style="list-style-type: none"> Inspect swing-away or flip-up supports to make sure they move freely but aren't too loose to rattle. Inspect fixed supports to make sure they're tightened. Nuts and bolts can work themselves loose or even all the way out, which could cause the support to fall off. Do not over-tighten a loose nut or bolt because that could damage the housing and/or break the bolt. Use an Allen wrench or open-end box-end wrench to tighten bolts.
Monthly	All supports (clean)	<ul style="list-style-type: none"> Wipe down the supports with a clean, damp cloth and soap.
Monthly	Positioning belt	<ul style="list-style-type: none"> Check the buckle latches and the hardware that attaches the strap to the frame. These parts should be in good shape. The latch on the belt should not slip or become unlatched easily. Inspect the strap and Velcro (when applicable) for any signs of wear.
Monthly	Upholstery	<ul style="list-style-type: none"> Clean upholstery with a clean, damp cloth and soap.

Frame

Timing	Part/Area	What to Do
Daily	Shrouds	<ul style="list-style-type: none"> • A shroud is a piece of the wheelchair, usually made of plastic, that covers parts of the wheelchair that shouldn't be exposed, such as joints or electronics. • Check that shrouds are attached and intact. Wiggle the shrouds to make sure they're not loose. • Damage to the plastic covers or shrouds will allow moisture and dirt to damage the frame or electronics. • Contact a wheelchair maintenance expert to replace damaged shrouds.
Monthly	Welds	<ul style="list-style-type: none"> • Inspect the frame, weld points, and all holes and bends to confirm that they're intact. • Look for cracks and fractures. If these aren't fixed, the wheelchair can completely fail, which may lead to catastrophic injury or death. • If you find problems, contact a wheelchair maintenance expert immediately.
Quarterly	Suspension	<ul style="list-style-type: none"> • Power wheelchairs have suspension to improve ride comfort, reduce driving fatigue, and handle rough terrain. • Make sure the paint in the springs is intact and has no cracks. • Inspect the damper to make sure it's not leaking lubricant. • Be aware that when going over obstacles—for example, a speed bump—the wheelchair should not make noises. If it does, it may not be safe. At least three wheels should touch the ground at all times. • If you have had significant changes in weight, the suspension may not provide the same ride comfort. • Contact a maintenance expert regarding issues with suspension.
Monthly	Whole frame	<ul style="list-style-type: none"> • Wipe down the entire frame with a clean, damp cloth and soap. • Cleaning the wheelchair may stop metal parts from rusting and may stop damage caused by dirt scraping against moving parts.

Electrical system

Timing	Part/Area	What to Do
Daily	Motor disengage levers	<ul style="list-style-type: none"> • Make sure the wheelchair can't move by itself when the lever is engaged. • Make sure it can move when the lever is disengaged.
Daily	Motor noise	<ul style="list-style-type: none"> • The motors are the heart of any power wheelchair. They convert the electrical energy of the batteries to mechanical work. In many cases, one motor is used to drive each wheel. Motor failure can leave the wheelchair user stranded. • Listen to your motor. Become familiar with the healthy sound of your wheelchair when it's new. Over time, just like a car, the motor will become a little noisier. But if your ear is tuned to how it should sound, you'll know when there is excessive noise. Increased noise might indicate worn bearings, out-of-line belts or gears, or problems with the frame. • If you hear any unfamiliar or unrecognized noises, contact a wheelchair maintenance expert.
Daily	Driving and braking systems	<ul style="list-style-type: none"> • Turn down the speed. • Command the wheelchair to go forward with the joystick or alternative control system (e.g. head control), until you hear the brakes click, then immediately (choose one) <ul style="list-style-type: none"> ○ Release the joystick, ○ Put the joystick in reverse, or ○ Turn the wheelchair off (recommended). This is the only way to check if the brakes work right away.
Daily	Power seat functions	<ul style="list-style-type: none"> • Inspect the full range of all power seat functions. First tilt, then recline, and finally elevate the legs.

Electrical system (continued)

Timing	Part/Area	What to Do
Daily	Controller, joystick, other controls, indicators, and horn	<ul style="list-style-type: none"> Inspect all controls, indicators, driving features, and the horn to make sure they are working smoothly and consistently. To inspect the joystick, turn OFF the controller. Check the joystick and rubber boot around the base of the joystick for damage. The joystick should return freely to neutral without binding. Check that the seal on the joystick is intact. The seal protects the joystick from dirt and water. Check that all switches and controls are tightly in place. Joystick problems may cause a malfunction in the wheelchair's operation as well as damage to the electronics. To avoid excessive moisture in the controller, always carry a gallon-size plastic bag to cover the joystick and controller if it rains to prevent moisture accumulation. If the joystick/controller gets wet, use a hair dryer to blow through the charge/controller plug.
Daily	Battery charge	<ul style="list-style-type: none"> Batteries are the fuel system for power wheelchairs. If the batteries do not work properly, the wheelchair will not work properly. Maintaining the batteries is vital to the performance of the wheelchair. Batteries last longer if they are never run completely flat. However, charging too frequently when the batteries have only been used a little will also decrease the batteries' life. For most wheelchairs, the ideal charging point is when the charge indicator is at 50%. Charge batteries every night and only with the charger provided with the wheelchair. Make sure the battery charger is plugged in and working, and always keep it dry. Batteries should be charged and maintained by a wheelchair maintenance expert. Contact one if your batteries aren't keeping a charge.
Monthly	Power seat functions (clean and lubricate)	<ul style="list-style-type: none"> Power seat functions benefit people who can't move or reposition themselves effectively without help. These functions redistribute pressure, manage posture and tone, provide comfort, and help with personal care activities. When inspecting these functions to make sure they work properly, first tilt, then recline, and finally elevate the legs. Take each power seat function to its full range. Clean all parts. Do not remove the grease in the elevating seat mechanisms. Grease acts as a lubricant that helps the parts move and work as they should. If the power seat malfunctions, the user may be left in an unsafe position for driving or at risk for pressure sores. Contact a wheelchair maintenance expert if you find problems such as grinding noises, jerking, or the seat functions not working consistently.
Monthly	Wiring and electronic connections	<ul style="list-style-type: none"> Wires and electrical connections must be intact for the wheelchair to work properly. Check all electrical connections to ensure they're firmly in place and free of grime and corrosion. Connectors may loosen from bumps and vibrations. Cable ties can be used to secure loose wires. Before securing cable ties, ensure that they are safely away from moving parts and do not restrict the seat positioning. Clean corrosion from connectors. Corrosion can keep motors from driving and batteries from charging. Make sure that all cables and wires are clean and intact. If you find any problems, contact a wheelchair maintenance expert.

References

- Hansen, R., Tresse, S., & Gunnarsson, R. (2004). Fewer accidents and better maintenance with active wheelchair check-ups: A randomized controlled clinical trial. *Clinical Rehabilitation*, 18(6), 631–639.
- Kirby, R., & MacLeod, D. (2001, June 22–26). Wheelchair-related injuries reported to the National Electronic Injury Surveillance System: An update. In: *Proceedings of the RESNA 2001 annual conference* (pp. 385–387). Arlington, VA: Rehabilitation Engineering and Assistive Technology Society of North America.
- McClure, L. A., Boninger, M. L., Oyster, M. L., Williams, S., Houlihan, B., Lieberman, J. A., & Cooper, R. A. (2009). Wheelchair repairs, breakdown, and adverse consequences for people with traumatic spinal cord injury. *Archives of Physical Medicine and Rehabilitation*, 90(12), 2034–2038.
- Toro, M. L., Worobey, L., Boninger, M. L., Cooper, R. A., & Pearlman, J. (2014, June 11–15). *Type and frequency of reported wheelchair repairs and adverse consequences among people with spinal cord injury*. Presentation at the Rehabilitation Engineering and Assistive Technology Society of North America Conference, Indianapolis, IN.
- Worobey, L., Oyster, M., Nemunaitis, G., Cooper, R., & Boninger, M. L. (2012). Increases in wheelchair breakdowns, repairs, and adverse consequences for people with traumatic spinal cord injury. *American Journal of Physical Medicine and Rehabilitation*, 91(6), 463–469.
- Xiang, H., Chany, A., & Smith, G. (2006). Wheelchair related injuries treated in U.S. emergency departments. *Injury Prevention*, 12(1), 8–11.

Also in the SCI Model Systems Consumer Information Series on Wheelchairs:

- Getting the Right Wheelchair: What the SCI Consumer Needs to Know
- The Power Wheelchair: What the SCI Consumer Needs to Know
- The Manual Wheelchair: What the SCI Consumer Needs to Know

Authorship

Maintenance Guide for Users of Manual and Power Wheelchairs was developed by Sara Munera Orozco, MS, Jon Pearlman, PhD, Lynn Worobey, PhD, Michael Boninger, MD, in collaboration with the Model Systems Knowledge Translation Center.

Source: The content is based on research and/or professional consensus. This content has been reviewed and approved by experts from the SCI Model Systems (SCIIMS), funded by the National Institute of Disability, Independent Living, and Rehabilitation Research.

Disclaimer: Do not try to fix or replace any wheelchair component if you don't feel comfortable doing it. Contact a wheelchair maintenance expert once a year to perform a complete wheelchair maintenance.

The content of this factsheet does not replace the advice of a medical professional. You should consult a health care provider about specific medical concerns or treatment. The content of this factsheet was developed under a grant from the National Institute on Disability, Independent Living, and Rehabilitation Research (NIDILRR grant number 90DP0012). NIDILRR is a Center within the Administration for Community Living (ACL), Department of Health and Human Services (HHS). The content of this factsheet does not necessarily represent the policy of NIDILRR, ACL, HHS, and you should not assume endorsement by the Federal Government.

Copyright © 2018 Model Systems Knowledge Translation Center (MSKTC). You can freely reproduce and distribute this content. Include proper attribution. But you must get permission before using this content in fee-based products.



Nutrition and Spinal Cord Injury

October 2023

<https://msktc.org/sci/factsheets>

SCI Factsheet

Keys to good health start with understanding nutrition and following a healthy, nutritious diet. This factsheet provides insight into the impact of nutrition on health, wellness, daily activities and overall quality of life after spinal cord injury.

What Is Nutrition?

Nutrition is the way your body uses the six major nutrients needed for health and function.

- Water
- Protein
- Carbohydrates
- Fats
- Vitamins
- Minerals

Why Is Nutrition Important?

Your body changes after spinal cord injury (SCI). There is usually reduced muscle and bone mass, added fat, and other changes that make it critical to follow a healthy diet regimen to maintain and improve your health.



- Healthy eating can help lower your risk for becoming overweight or obese and for developing other medical complications, such as constipation, diarrhea, diabetes, infections, and limit your muscle loss.
- Food choices and portion sizes determine how many calories you consume. Extra calories lead to weight gain and affect your daily activities, such as strength, stamina, and transferring.
 - Choose foods that are rich in nutrients while staying within your calorie limits.
- Healthy eating can help improve mental health, physical health and independence.
- Exercise and physical activity can help boost the benefits of healthy eating.

The Model Systems Knowledge Translation Center works with Spinal Cord Injury Model System (SCIMS) centers to provide free research-based rehabilitation resources for people living with spinal cord injury (See <https://msktc.org/sci> for more information). This factsheet has been approved by experts from the SCIMS centers.

Do Most People With SCI Get Proper Nutrition?

Research shows that many people with SCI do not get proper nutrition. They tend to have diets that are low in fruits, vegetables, and whole grains that are rich in fiber, vitamins, and minerals. They also tend to eat more processed foods, especially fast food, that are usually high in sodium, sugar, and fat.

- Healthy eating is harder if you have limited mobility, income, or access to transportation. These and other factors may be out of your control, but you can learn about nutrition to explore ways to healthier eating, such as choosing healthier frozen meals and snacks. Even small improvements can benefit your health.



Should I Talk to a Health Professional About My Diet?

Health professionals recommend healthy eating, so most often you can start making healthy food choices on your own. Still, it can be hard to finding health professionals who know a lot about SCI. Here are a few helpful suggestions.



- Rely on your health professional for nutritional guidance if you have medical conditions with dietary restrictions. These include heart disease, diabetes, and other conditions.
- Be mindful that commercial diet programs target the general population and do not consider your personal nutritional needs.
- Review your dietary habits with your health professional every year to talk about how your diet affects your health-related concerns and nutritional and calorie needs. This includes your meals, drinks, snacks, and supplements.
- People with SCI who have difficulty preparing healthy meals may find it helpful to talk to a registered dietitian or registered nutritionist about suggesting healthier food choices that are also easier to prepare.

How Do the Six Major Nutrients Affect My Health?

Water

Proper hydration is needed to stay healthy. Here are a few of the vital health benefits of staying hydrated.

- Flushes out bacteria from the bladder
- Helps prevent constipation
- Maintains body temperature
- Keeps the skin moist, supple, and healthy

Your body absorbs a small amount of water from the foods you eat, but what you drink is your body's main source of fluids.

- Drink plenty of water and limit drinks with sugar, caffeine, and alcohol because they flush water out of your body and are often full of unnecessary calories from sugar and fat, which can lead to weight gain.

The “ideal” amount of water to drink to stay hydrated varies greatly from person to person. The color of your urine usually gives you a good idea of whether your body is properly hydrated. Ideally, your urine should be golden yellow (see graphic). Drink a little less water if your urine tends to be pale yellow or clear. Drink more water if your urine tends to be darker.

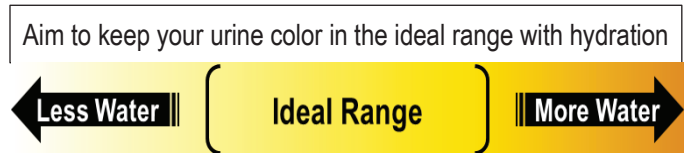

- Be aware that some foods and dietary supplements affect the color of your urine. For example, Vitamin B2 can turn urine bright yellow. Foods such as blackberries, beets, and rhubarb can darken the color of your urine.
- You may need to talk to your health professional about your water intake and adjusting your bladder management if you change your water intake.
- Proper water intake helps to maintain your blood pressure within normal range and prevent respiratory tract infections like pneumonia.

Protein

Protein helps your body maintain a good immune system and fight infection. It helps muscles stay strong and skin stay healthy. Your protein needs depend on your age, gender, body weight, and exercise levels. Your health professional may also recommend more protein to help wound healing.



- Foods with a high protein-to-calorie ratio include seafood, lean meats and poultry, eggs, legumes (beans and peas), nuts, seeds, soy products, and fat-free or low-fat dairy (including milk, yogurt, cheese, and/or soy beverages).
- It is important to eat a variety of healthy foods with protein. If you prefer plant-based protein, make sure to combine different sources, such as grains and legumes, nuts and seeds and legumes.
- You might consider protein supplements like shakes and bars when you cannot get enough protein from food sources. However, it is easier to take in too much protein when taking proteins supplements. Consult your physician regarding any potential adverse effects.



Carbohydrates

Carbohydrates are an important source of energy that support your body's functions and physical activity. Choosing carbohydrates high in fiber and nutrients, and low in added sugar may help prevent weight gain, diabetes, and improve your bowel health.

- Healthy sources of carbohydrates are unprocessed or minimally processed whole grains, vegetables, fruits, and beans. These foods promote good health by providing your body with vitamins, minerals, fiber, and other important nutrients.
- Unhealthy sources of carbohydrates include white bread, pastries, sugar-sweetened beverages, and other highly processed or refined foods. High intake of unhealthy carbohydrates increases sugar levels, which increases your risk for diabetes and all its complications.
- Be mindful that you need carbohydrates to support your body's functions and physical activity but excess carbohydrate intake converts into fat and increases triglyceride levels, which increases your risk for heart disease and stroke.

A Note on Fiber

Fiber is an important part of bowel management after SCI. You want to gradually decrease or increase your fiber intake and drink plenty of water to help avoid diarrhea or constipation if you are adjusting your fiber intake.

- Soluble fiber helps to firm stool and reduce diarrhea. Sources include oats, peas, beans, apples, citrus fruits, carrots, and barley.
- Insoluble fiber helps to prevent constipation and infections in the gut. Sources include whole-wheat flour; wheat bran; nuts; and beans and vegetables, such as cauliflower, green beans, and potatoes.

Fats

You need healthy fats to give your body energy and support cell growth. They also help to protect your organs, keep your body warm, help your body absorb certain vitamins, and produce important hormones. Fats are high in calories and can add up quickly. Consuming more calories than you burn off—regardless of the calorie source—usually results in gaining body fat.

- “Healthier” unsaturated fats include monounsaturated and polyunsaturated fats. Foods high in healthier fats include vegetable oils (such as olive, canola, sunflower, soy, and corn), nuts, seeds, and fish.
- “Unhealthy” fats are high in saturated or trans fats. These fats lead to heart disease and stroke. Examples of unhealthy fats are hot dogs, poultry skin, bacon, sausage, high-fat



luncheon meats (such as salami and bologna), whole milk, butter, most fried foods and fast foods, and desserts and sweets made with lard, butter or tropical oils. Limit these fats to no more than about 5% of your total daily calories. High intake of unhealthy fats can lead to cardiovascular disease and can result to heart attacks or strokes.

- When deciding between fat sources, refer to the nutrition label (next page). Usually, the lesser saturated and trans-fat content, the better, and the more monounsaturated and polyunsaturated fats, the better.

Vitamins and Minerals

Vitamins and minerals are essential to your health. Overall, natural sources offer the healthiest vitamins and minerals. A quality multivitamin supplement may be helpful, so talk to your health professional about whether a supplement is right for you.



- **Calcium:** It is the most abundant mineral in the body. Calcium is important for bone mass, and bone loss is common after SCI. This loss puts you at risk for developing osteoporosis as you age, especially if you are a woman. Proper calcium intake can help minimize that risk. Good sources of calcium include low-fat dairy foods like milk, cheese, yogurt, and non-dairy foods like seafood, leafy greens, legumes, dried fruit, and tofu.
- **Sodium:** Sodium (salt) affects blood pressure. Too much sodium can increase blood pressure and lead to health problems like heart disease and stroke. Too little sodium can lead to low blood pressure and other problems like muscle cramps, nausea, vomiting and dizziness. It is common for people to take in too much sodium by eating processed and fast foods. Instead, focus on fruits and vegetables, whole grains, and lean meats that are lower in sodium.
- **Vitamin D:** It is necessary for your body to absorb calcium for bone health. You get vitamin D in two ways. Direct sunlight is one natural source of vitamin D. However, you may not get enough vitamin D from sunlight. You can also eat fatty fish, fortified milk or milk alternatives, mushrooms, and lean meat to get vitamin D.
- **Vitamin B12, folic acid, and iron:** These help your body produce hemoglobin, which aids in getting enough oxygen in your body to maintain organ and tissue health. Good sources of B12 include lean meat, fish, poultry, and milk. Sources of folic acid include beans; peas; nuts; oranges and orange juice; and dark-green leafy vegetables, such as spinach and mustard greens. Sources of iron include lean meat, poultry, seafood, fortified cereals, white beans, lentils, and spinach.
- **Vitamin C and zinc:** These promote skin health. Vitamin C helps the body absorb iron more effectively and helps fight infections. Good sources of vitamin C include red pepper, orange juice, orange, kiwi, and broccoli. Sources of zinc include lean meat, liver, eggs, legumes, seafood, and milk.

How Do I Change My Nutrition Habits?

You do not need to change everything in your diet. Start by understanding what is in your food and choosing healthier options. The Nutrition Facts Label is a good starting point.

Nutrition Facts	
4 servings per container	
Serving size 1 cup (227g)	
Amount per serving	
Calories 280	
	% Daily Value*
Total Fat 9g	12%
Saturated Fat 4.5g	23%
Trans Fat 0g	
Cholesterol 35mg	12%
Sodium 850mg	37%
Total Carbohydrate 34g	12%
Dietary Fiber 4g	14%
Total Sugars 6g	
Includes 0g Added Sugars	0%
Protein 15g	
Vitamin D 0mcg	0%
Calcium 320mg	25%
Iron 1.6mg	8%
Potassium 510mg	10%

* The % Daily Value (DV) tells you how much a nutrient in a serving of food contributes to a daily diet. 2,000 calories a day is used for general nutrition advice.



Nutrition Facts Label

The nutrition facts label has information about the number of servings in a package, calories, fat, protein, sodium, and vitamins and minerals per serving.

- When choosing between similar foods, choose those higher in monounsaturated and polyunsaturated fats and lower in saturated and trans fats along with those with lower in sodium and sugars.
- % daily value is based on the diet of an average person who consumes 2,000 calories per day.
- More or fewer calories may be needed depending on your age, gender, weight, height, injury level, and physical activity level.

What I usually eat	Healthier options
Fried chicken or fish	Grilled or baked options with lower fat
Canned fruits in syrup	Fresh fruits or canned fruits in 100% juice
Regular bacon	Uncured, sugar-free, low sodium, or turkey bacon
Canned soup	Low-sodium versions of your favorite soup
Salt	Salt alternatives or use citrus, herbs and spices to add flavor to your meals
Chips, pretzels, or crackers	Roasted, lightly or unsalted nuts or baked and whole-grain versions of these snacks
Ice cream	Less sugar/lower fat ice cream, less sugar sorbet, frozen fruits
Whole-fat dressing	Low-fat version of the same dressing, citrus, or balsamic vinegar
Pizza	Thin crust with vegetable or grilled meat toppings
Sweet tea	Unsweetened tea or sweet tea mixed with unsweetened tea to reduce sugars
Deep fried food (fries, meat)	Baked or air-fried version to cut down fat
Spaghetti and meatballs	Whole grain pasta and turkey meatballs
Milk shake	Homemade smoothies using fruits as natural sweetener

Is a Diet Change All I Need to Do to Be Healthy?

A healthy diet will improve your health, but you can increase your health benefits by combining a healthy diet with other lifestyle changes, such as including physical activities, limiting alcohol use and smoking, as well as maintaining good mental health.

- Alcohol affects your ability to perform daily activities of living and care, lowers your body's ability to fight infections, adds calories that can lead to weight gain, interacts with your medications, and disrupts your gut health.
- Smoking increases your risk for respiratory complications (pneumonia), cardiovascular complications (blood flow), cancer, osteoporosis (bone loss), pressure injuries, pain, and erectile dysfunction.



Additional Resources

Your nutrition intake affects many secondary health conditions related to SCI. These resources can help you understand and manage those issues.



- To learn more about what a Registered Dietitian Nutritionist can do for you, visit <https://www.eatright.org>.
 - EatRight® SCI Weight Management Program—visit <https://www.uab.edu/medicine/sci/uab-scims-information/eatright-weight-management-program>.
- To learn more about physical activities, read [Adaptive Sports and Recreation | MSKTC](#) and [Exercise after Spinal Cord Injury](#).
- To learn more about bone loss, read [Bone Loss After Spinal Cord Injury](#).
- To learn more about respiratory health, read [Respiratory Health and Spinal Cord Injury](#).
- To learn more about pregnancy care, read [Pregnancy and Women with Spinal Cord Injury](#).
- To learn more about skin care, read [Skin Care and Pressure Sores in Spinal Cord Injury](#).
- To learn more about spasticity, read [Spasticity and Spinal Cord Injury](#).
- To learn more about urinary tract infection, read [Urinary Tract Infection and Spinal Cord Injury](#).
- To learn more about constipation, read [Bowel Function and Spinal Cord Injury](#).
- To learn more about cardiovascular risk, read [Aging with Spinal Cord Injury](#).

Nutritional Needs Table (next page)

The nutritional needs table on the next page guides you in promoting overall health and improving everyday problem issues with your bowel, bladder, skin, bone, and muscle.

1. Column 1 offers a list of nutrients that are key to overall health.
2. Column 2 offers checkmarks that tell you what nutrients affect infections (Immune System).
3. Column 3 offers checkmarks that tell you what nutrients affect bowel management.
4. Column 4 offers checkmarks that tell you what nutrients affect skin care and wound healing.
5. Column 5 offers checkmarks that tell you what nutrients affect muscle and bone health.
6. Column 6 provides examples of dietary sources.



Nutritional Needs Table

Infection (Immune System)	Bowel Management	Skin Care/Wound Healing	Muscle and Bone Health	Cardiovascular Health	Pulmonary Health	Diabetes Prevention
---------------------------	------------------	-------------------------	------------------------	-----------------------	------------------	---------------------

Number key:

1. Increase intake if urine is too dark or decrease intake if urine is too clear.
2. Increase intake with diarrhea or constipation.
3. Adjust gradually if needed.

Nutrients	Examples of dietary sources							
Water	✓ ¹	✓ ²	✓				Water, non-sugar-sweetened beverages	
Protein			✓	✓			✓	Lean meat, nuts, beans and legumes, fish and seafood, low-fat dairy products
Fiber		✓ ³			✓	✓		Fruits and vegetables, whole grains, legumes, nuts, seeds
Calcium				✓			✓	Dairy products and calcium-fortified dairy alternatives, leafy green vegetables, broccoli, tofu, salmon
Folic acid			✓		✓			Dark-green leafy vegetables, fortified cereals, flour
Iron			✓					Lean meat and seafood, iron-fortified cereal and instant oatmeal, nuts, beans
Zinc	✓		✓	✓		✓	✓	Oysters, low-fat roast beef and poultry, crab, lobster, beans, nuts
Magnesium	✓			✓	✓	✓	✓	Green leafy vegetables, legumes, nuts, seeds, whole grains
Potassium				✓	✓		✓	Fruits and vegetables, legumes (e.g., soybeans), and potatoes
Vitamin A	✓				✓	✓		Liver, fish oils, milk, eggs, vegetables, fruits, fortified cereals
Vitamin B6	✓		✓					Fish, beef liver and other organ meats, potatoes, non-citrus fruits, fortified cereals
Vitamin B12			✓					Lean meat, low-fat dairy products, fortified cereals, yeast
Vitamin C	✓		✓	✓		✓		Citrus, tomatoes, potatoes, bell peppers, kiwifruit, broccoli, strawberries, Brussels sprouts, cantaloupe
Vitamin D	✓			✓		✓	✓	Fatty fish, UV-treated mushrooms, fortified dairy products and cereals
Vitamin E	✓					✓		Nuts, seeds, vegetable oils, green leafy vegetables, fortified cereals
Vitamin K				✓			✓	Green leafy vegetables, canola oil



Authorship

Nutrition and Spinal Cord Injury was developed by Jia Li, PhD, Ceren Yazar-Fisher, PT, PhD, Elizabeth Pasipanodya, PhD, Ashraf Gorgey, MPT, PhD, FACSM, FACRM, Shelley Wood, MPH, RDN, and Phil Klebine, MA; in collaboration with the SCI Model Systems Knowledge Translation Center.

Source: The content in this factsheet is based on research and/or professional consensus. This content has been reviewed and approved by experts from the Spinal Cord Injury Model Systems (SCIMS) centers, funded by the National Institute on Disability, Independent Living, and Rehabilitation Research (NIDILRR). The content of the factsheet has also been reviewed by individuals with SCI and/or their family members.

Disclaimer: This information is not meant to replace the advice of a medical professional. You should consult your health care provider regarding specific nutritional needs, medical concerns or treatment. The contents of this factsheet were developed under grants from the National Institute on Disability, Independent Living, and Rehabilitation Research (NIDILRR grant numbers 90DPKT0009, 90SIMS0020, 90SIMS0006, and 90SIMS0014). NIDILRR is a Center within the Administration for Community Living (ACL), Department of Health and Human Services (HHS). The contents of this fact sheet do not necessarily represent the policy of NIDILRR, ACL, HHS, and you should not assume endorsement by the federal government.

Recommended citation: Li, J, Yazar-Fisher, C, Pasipanodya, E, Gorgey, A, Wood, S, & Klebine, P. (2023). *Nutrition and spinal cord injury* [Fact sheet]. Model Systems Knowledge Translation Center (MSKTC). <https://msktc.org/nutrition-and-spinal-cord-injury>

Copyright © 2023 Model Systems Knowledge Translation Center (MSKTC). May be reproduced and distributed freely with appropriate attribution. Prior permission must be obtained for inclusion in fee-based materials.



Opioids and Your Health

January 2021

www.msktc.org/SCI/factsheets

SCI Factsheet

This factsheet explains how opioids can affect your health after a spinal cord injury (SCI). It also describes problems to watch for if you take opioids for any reason.

Opioids are drugs naturally found in the opium poppy plant. While some opioids like morphine are made from the plant directly, others such as fentanyl and tramadol are created in a lab. Opioids are often used as medicines because they can relieve pain. However, opioids can also make people feel very relaxed or "high" which is why they are sometimes misused for non-medical reasons. Opioids are addictive. Overdoses and death are more common when people use opioids for non-medical reasons; however, as more and more people have been prescribed opioids for the treatment of severe pain, there has been an increase in overdose deaths reported in persons who are prescribed opioids for pain as well. This factsheet provides an overview of opioids and their effects on your health.



What you need to know about opioids

- Opioids have side effects that can affect your health.
- Many people get used to opioids over time and need higher doses to get the same effect.
- Even if prescribed by a doctor for pain, taking opioids can lead to an opioid use disorder, addiction, or accidental overdose.
- There are effective treatments for opioid use disorders.
- Opioid use is linked to serious risks such as accidental overdose and death.
- Risks of overdose or death go up when opioids are taken at high doses but can occur even with low doses.
- Accidental overdose can occur even if opioids are prescribed for pain.
- There are other treatments other than opioids for pain. Please see the MSKTC fact sheet on Pain after SCI at <https://msktc.org/sci/factsheets/pain>.

The Spinal Cord Injury Model System is sponsored by the National Institute of Disability, Independent Living, and Rehabilitation Research, U.S. Department of Health and Human Services' Administration for Community Living. (See <http://www.msktc.org/sci/model-system-centers> for more information).

Are opioid pain medicines right for you?

People with SCI are more likely to be prescribed an opioid than someone without an SCI. This is because four out of five people with an SCI have ongoing pain. Pain interferes with activities of daily living or work for one third of people with ongoing pain.

Compared with people without an SCI, people with an SCI have an increased risk of having many of the side effects of opioids. They are also at higher risk of having adverse health effects from opioid use.



Due to these risks, doctors recommend only using opioids to treat pain under the following circumstances:

- Severe acute pain from an injury or illness that can't be controlled with other treatments such as non-opioid pain relievers or physical therapy treatment. In this case, opioids should only be used for 1–2 weeks.
- Severe pain from cancer.
- Severe chronic pain (pain that has been present for more than 3 months) when all other non-opioid treatments have been tried and when
 - **For people not already on opioids**, there is both less pain and an improvement in the ability to perform daily activities during a trial of a low to moderate dose of opioids lasting no longer than 3 months. (See below for more dosing details.)
 - **For people on a low or moderate dose of opioids**, there is both less pain and an improvement in the ability to perform daily activities. Also, the benefits of ongoing opioid use outweigh the harms and potential risks.

What is the right opioid dosage for you?

When compared milligram (mg) to milligram, some opioids are stronger than others. To compare opioid doses between different types of opioids, opioid researchers developed a tool to equalize the many different opioid doses into one standard value. This standard value is based on the strength of morphine. It's called a morphine milligram equivalent (MME). Some opioids such as oxycodone and hydromorphone are stronger than morphine when compared on a milligram to milligram basis; these opioids have higher corresponding MME values. Other opioids such as tramadol and codeine are weaker than morphine when compared on a milligram to milligram basis; these opioids have lower corresponding MME values. This is important to identify high-risk opioid doses that can lead to accidental overdose and death.



Opioid doses should not exceed 60 MMEs per day; this is generally regarded as a moderate dose. Low doses are less than 20 MMEs per day. Doctors recommend that people taking more than 60 MMEs per day taper to a dose less than 60 MME per day. If you take opioids for chronic pain, ask your doctor how many MMEs you take each day. If you take more than 60 MMEs each day, ask your doctor about how to safely lower your dose. Do not just lower the dose on your own without guidance from your doctor.

What are the effects of opioid use?

Potential effects of taking opioids include constipation; respiratory depression and sleep apnea; decreased ability to think, confusion, drowsiness, and sedation; bad dreams or hallucinations; and decreased sex drive and other effects of low hormone levels.

Other potential effects of taking opioids include increased pain sensitivity, tolerance to opioid effects, withdrawal if you stop taking them, developing an opioid use disorder or an addiction to opioids, having a child with birth defects if you are pregnant while taking opioids, and dying from an overdose.

For each of these effects, please see the additional information below:

Constipation

Opioids can slow down the muscles in the gut and cause hard stools and constipation. Constipation can cause nausea and vomiting.



People with an SCI usually have a neurogenic bowel. This means that a nerve problem has caused the bowel to stop working normally and slow down.

Having both constipation from opioids and constipation from a neurogenic bowel can make having a bowel movement much more difficult.

Effective treatments for constipation are available. They include over-the-counter laxatives and stool softeners such as senna, polyethylene glycol, and docusate. Other options include medicines that block the effects of opioids on the gut. If you have constipation caused by opioids, ask your doctor what you can do. The factsheet developed by the Model Systems Knowledge Translation Center (MSKTC) on bowel function may also be useful. It can be found at https://msktc.org/sci/Hot-Topics/Bowel_Function.

Respiratory depression and sleep apnea

Using opioids can slow your breathing and make your breaths shallower. This is called respiratory depression. Although this may happen when you are awake or asleep, it's usually more obvious when you're asleep. Sleep apnea is a disorder in which a person has periods of shallow breathing or stops breathing. If you live alone, it may be hard to know if you have sleep apnea. Even though sleep apnea may not wake you up, it will disrupt your sleep; this may make you sleepy during the day, no matter how long you sleep at night. Both opioid use and SCI cause sleep apnea; having both raises the risk of serious health effects.

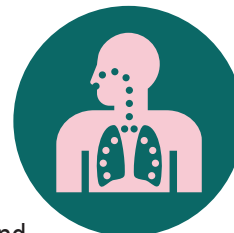

Without treatment, sleep apnea alone may raise your risk of heart attack, stroke, heart failure, and of having a car crash. The most severe problem caused by respiratory depression is death.

Sleep apnea can be treated in a number of ways. The most common and effective treatment is continuous positive airway pressure (CPAP), which requires wearing a mask that is connected to a machine to help you breathe while you sleep. If you need long-term opioid treatment, ask your doctor about being tested for sleep apnea. The MSKTC factsheet on respiratory health and spinal cord injury may also be helpful. It can be found at <https://msktc.org/sci/factsheets/respiratory>.

Decreased ability to think, confusion, drowsiness, and sedation

Using opioids can affect your ability to concentrate and remember things. It can affect your ability to understand complex information. It can also slow down your reaction time. Opioids can also make you feel drowsy or sleepy.

Stimulant medicines may be used to help you feel less drowsy when taking opioids. If you think opioids are affecting your thinking or level of alertness, ask your doctor what you can do to lessen or stop these side effects.

Bad dreams or hallucinations

Using opioids can make you have bad dreams or see things that aren't there (hallucinations). Using a lower dose or switching to a different opioid may ease these side effects. Talk to your doctor about what you can do to help with bad dreams or hallucinations if you have them.

Decreased sex drive and other effects of lower hormone levels

For men, using opioids can lower levels of a hormone called testosterone. Opioid use can also decrease sex drive, and the ability to have erections and orgasms. For women, in addition to decreasing sex drive and

orgasms, using opioids may cause irregular menstrual cycles. In both men and women, low testosterone may cause weight gain, fatigue, hot flashes, night sweats, depression, and loss of muscle mass. People with SCI often have erectile dysfunction or vaginal lubrication dysfunction. Using opioids after SCI can make these things worse.

Testosterone replacement is an effective treatment for low testosterone levels caused by opioid use. This treatment can be given either through injections into the muscle or by wearing a medicated patch. Regular exercise can help offset loss of muscle mass due to the hormonal changes you may have when taking long-term opioids for pain. Ask your doctor about the effects of lower hormone levels caused by long-term opioid use.

Birth defects

Pregnant women who take opioids are twice as likely to have a baby born with birth defects such as spina bifida and congenital heart defects. Finding other treatments for pain before you become pregnant reduces your risk of having a child with birth defects to normal.



Increased pain sensitivity

Using opioids, especially at high doses for long periods, often makes people more sensitive to pain. This increased sensitivity is not just related to the specific pain someone is experiencing but to any pain they might experience. In many cases, taking a lower dose of opioid, changing to a different opioid, or even stopping the opioid (after gradually taking a lower and lower dose) altogether may decrease any increased pain sensitivity caused by opioid use.

Opioid tolerance

Most people who take an opioid for pain will develop tolerance to the drug. Tolerance occurs when the body gets used to a drug. As a result, people take more medicine or a different medicine to get the same effect. If you keep taking the same dose of an opioid, it often won't work as well over time.

Withdrawal symptoms

Withdrawal symptoms occur when people who have been taking opioids stop taking them or cut the dose suddenly. This is especially true if you've been taking them for more than a few weeks or if you've been taking high doses. Withdrawal symptoms may include seizures, increased pain, autonomic dysreflexia symptoms due to increased pain, anxiety, cravings for the opioid, a feeling of being unwell, sweating, and yawning. The MSKTC factsheet on autonomic dysreflexia has information about the symptoms of autonomic dysreflexia. It can be found at https://msktc.org/sci/factsheets/autonomic_dysreflexia. Other symptoms of withdrawal include "goosebumps," or small bumps on the skin; excessive tears; a runny nose; an inability to sleep; nausea; vomiting; diarrhea; seizures; anxiety; opioid cravings; sweating; yawning; cramps; muscle aches; and fever.

- With short-acting opioids, withdrawal symptoms may first appear within 12 hours of the last dose and may last 7–10 days.
- With a long-acting opioid, symptoms may start within 1–2 days of the last dose, and symptoms may last a few weeks.

If you want to lower your daily dose of opioids, slowly decreasing the dose over time can help prevent or lessen withdrawal symptoms.

Opioid use disorder

Opioid use disorder is a condition in which a pattern of opioid use leads a person to have impaired mental function or distress. This disorder also affects life activities and relationships. It often includes a strong urge to use opioids and an inability to control or reduce opioid use. There is usually an increased tolerance to opioids. Withdrawal symptoms (see above) may occur when opioids are suddenly stopped. Addiction is the most severe form of the disorder.

The most effective treatment for opioid use disorder is opioid replacement therapy. With this treatment, either buprenorphine or methadone is substituted for your usual opioids. This therapy lowers your risk of accidental death from overdose, especially if used with behavioral therapy with a mental health professional. Behavioral therapy alone is less effective in preventing relapse and reducing the risk of death from accidental overdose. Abstinence, or not using opioids at all, is not usually effective in preventing relapse. If you think you may have an opioid use disorder, talk to your doctor about getting treatment.

Death from unintentional overdose

The main cause of death from opioid use is respiratory failure. Death occurs because not enough oxygen passes from the lungs to the bloodstream. The longer someone takes opioid medications and the higher the dose, the more likely they will develop respiratory failure and die. This is much more likely to occur in people who are taking high doses of opioids than in those who are taking low or moderate doses and in anyone with pulmonary disease or dysfunction.

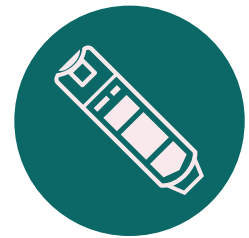

Having naloxone available and teaching those around you how to use it may save your life. The brand names are Narcan and Evzio. If you take too much opioid medication and stop breathing, naloxone may possibly reverse the overdose. If you are found unresponsive, you may have overdosed. Your pupils may be the size of a pinpoint; you may not be breathing. If this happens, those with you should give you the naloxone and call 911.

Naloxone is available over the counter in some states and by prescription in others. It can be given through a nasal spray or by injection under the skin or into a muscle. Ask your doctor how you can get naloxone and how it should be given to you if needed.

If you take opioids and benzodiazepines together, you are at increased risk of an unintentional overdose. If you take both, ask your doctor about safer options.

What are some common medicines that contain opioids?

Generic Name	Brand Name
Morphine	MS Contin, Roxinol, Arymo, Kadian
Codeine	Tylenol with codeine
Fentanyl	Duragesic, Actiq, Fentora
Hydrocodone	Vicodin, Norco, Lorcet, Lortab
Hydromorphone	Dilaudid, Exalgo, Palladone

Generic Name	Brand Name
Methadone	Methadose, Dolophine
Oxycodone	Percocet, Oxycontin, Roxycodone
Oxymorphone	Opana, Numorphone
Tramadol	Ultram, Ultracet

What are some common medicines that contain benzodiazepines?

Generic Name	Brand Name
Diazepam	Valium
Clonazepam	Klonopin
Alprazolam	Xanax

Generic Name	Brand Name
Temazepam	Restoril
Lorazepam	Ativan

If you aren't sure what medicines you're taking, contact your doctor.

Are there ways to treat pain without opioids?

Learn about other treatments for pain after SCI. Check out the MSKTC fact sheet on Pain after SCI at <https://msktc.org/sci/factsheets/pain>. Ask your doctor about other treatments.



Additional Resources

Taking Opioids Responsibly for Your Safety and the Safety of Others

(<https://www.va.gov/PAINMANAGEMENT/docs/TakingOpioidsResponsibly20121017.pdf#>)

Opioid Overdose: Information for Patients (<https://www.cdc.gov/drugoverdose/patients/index.html>)

Treating for Two: Medicine and Pregnancy: Use of Pain Medicine During Early Pregnancy May Be Related to Birth Defects (<https://www.cdc.gov/pregnancy/meds/treatingfortwo/index.html>)

Authorship

Opioids and Your Health was developed by Thomas N. Bryce, MD, Jan Schwab, MD, PhD, Philip Siddall MBBS, PhD, and Tiffany Wong, MD in collaboration with the Model Systems Knowledge Translation Center.

Source: Our health information content is based on research evidence and/or professional consensus and has been reviewed and approved by an editorial team of experts from the Spinal Cord Injury Model Systems.

Disclaimer: This information is not meant to replace the advice of a medical professional. You should consult your health care provider regarding specific medical concerns or treatment. The contents of this factsheet were developed under a grant from the National Institute on Disability, Independent Living, and Rehabilitation Research (NIDILRR grant number 90DP0082). NIDILRR is a Center within the Administration for Community Living (ACL), Department of Health and Human Services (HHS). The contents of this factsheet do not necessarily represent the policy of NIDILRR, ACL, HHS, and you should not assume endorsement by the Federal Government.

Copyright © 2020 Model Systems Knowledge Translation Center (MSKTC). May be reproduced and distributed freely with appropriate attribution. Prior permission must be obtained for inclusion in fee-based materials.



Pain after Spinal Cord Injury

May 2023

<https://msktc.org/sci/factsheets>

SCI Factsheet

This factsheet describes the types of pain that people with spinal cord injury may have. It also includes tips for how to manage pain.

Pain After SCI

Pain is a serious problem for many people with spinal cord injuries (SCIs). People with SCI may have pain in parts of the body where they have normal sensation (feeling); they may also have pain in areas that have little or no feeling. The pain is real and can have a negative impact on quality of life. A person in severe pain may have a hard time doing daily activities or taking part in enjoyable pastimes.



Most people with SCI have pain that doesn't go away or chronic pain. Chronic pain can last for months or years. The cause of the pain may not be known. But in most cases, it stems from nerve damage from the SCI or problems with muscles or joints. The pain may come and go. It is hard to eliminate chronic pain. But people with SCI can manage or lessen their pain enough so that it does not overwhelm their lives.

Chronic pain can cause or worsen problems such as depression, anxiety, and stress. This does not mean the pain is "all in your head." It means that pain and distress can make each other worse.

Even though pain after SCI can be complex and hard to treat, there are many treatments that can help. Understanding your pain, working with your doctor, and being open to a variety of treatments will help you manage your pain. It will also improve your quality of life. Many people who have chronic pain after SCI have found relief from the techniques described here.

The Model Systems Knowledge Translation Center works with Spinal Cord Injury Model System (SCIMS) centers to provide free research-based rehabilitation resources for people living with spinal cord injury (See <https://msktc.org/sci> for more information). This factsheet has been approved by experts from the SCIMS centers.

Types of Pain

Understanding what type of pain you have is key to choosing the right treatment. A person with SCI can have many different types of pain in different parts of the body; this may include areas where there is no feeling. Your doctor will ask you to describe your pain. They will want to know where it's at, how severe it is, how long you have had it, and what makes it worse or better. Your doctor also may ask you to have tests such as an X-ray or MRI (magnetic resonance imaging).

Neuropathic Pain

Neuropathic pain (nerve pain) after an SCI may be due to injury to the nerves in the spinal cord. It may also be due to injury to the nerves that exit the spinal cord, which are known as nerve roots. After SCI, the spinal cord and nerve roots can become very excitable and send signals to the brain for various sensations, such as cold,



hot, or pressure, for no reason. This can cause you to feel pain in areas of your body where you have little or no feeling. The brain may also amplify the signals it receives from the injured spinal cord or nerve roots. As a result, you may feel pain in an area with little feeling when touched by something that usually does not cause pain.

People use words such as *burning*, *stabbing*, *electric*, *numb*, or *tingling* to describe nerve pain. But nerve pain varies from person to person. It is often resistant to treatment. Because of this, a combination of treatments is most effective for nerve pain.



- **Note:** It is rare for people to develop new nerve pain due to their SCI more than one year after their injury. If new nerve pain starts years after the SCI, it may be due to a new medical problem. This may include a syrinx, a fluid-filled cavity that forms in the spinal cord. It is rare but may require surgery. Contact your doctor if you develop new nerve pain. In particular, you should reach out to your doctor if you notice any new loss of sensation, especially in areas around the level of your injury; new muscle weakness that doesn't get better with rest; or new or worsening spasticity.
- If nerve pain gets worse at any time, it might mean that another health problem is making the pain worse. Some common triggers that may make pain worse include constipation, a urinary tract infection (UTI), or depression. If these other health problems are the triggers, treating these problems may let the pain return to baseline or usual levels.

Musculoskeletal Pain

Musculoskeletal pain may be due to injury or overuse of muscles or arthritis of joints. It is a common problem for all people as they get older, including those with SCI. This type of pain often gets worse with movement and better with rest. There are three types:

- **Shoulder, arm, or hand pain.** This type of pain may be in the shoulder, elbow, or hand. It may be due to overuse of the muscles from doing an activity over and over. Examples include pushing a wheelchair, doing transfers, and doing pressure reliefs. Such pain can occur months or years after the SCI. Some people with high-level injuries may use computers or joysticks for tasks such as reading, communicating, or controlling devices in their home. They may develop pain in the hand, arm, or shoulder from overuse. This type of pain can make it hard for them to transfer safely, push a wheelchair, and do other activities of daily living, such as dressing and bathing.
- **Back and neck pain.** These types of pain are common. In people with paraplegia who have had surgery to fuse their spine, an increase in motion just above or below the fusion can lead to back pain. People with paraplegia and tetraplegia (quadriplegia) may also have back pain, especially if they can walk but still have weakness. People who use joysticks that they operate with their mouths or with head control switches may develop neck pain.
- **Muscle spasm pain.** This type of pain happens when muscles are tense and can't relax. This often happens with muscle weakness, imbalance, or overuse. This type of pain may be related to spasticity that is due to an SCI. Muscle spasms often occur in specific muscles or regions of the body. Although spasms cause many symptoms, they often feel like stiffness in muscles.



Visceral Pain

Visceral pain occurs in the organs of the body such as the stomach. People may describe this type of pain as cramping or dull and aching. It may cause nausea and vomiting. Constipation, a kidney stone, an ulcer, a gall stone, or appendicitis may cause this type of pain. People with SCI may not have the typical symptoms that come with these health problems. That is why it is important to see a doctor who has experience caring for patients with SCI to get the correct diagnosis and treatment.



People may feel visceral pain in an area that is not near the source of the problem. This is known as *referred* pain. One common example is shoulder pain that results from gallbladder disease.

Managing Pain After SCI

Because pain may have many different causes, there is no single way to treat it. You and your doctor may need to try a combination of medicines, therapies, and other treatments. These may include:

Physical Treatments and Interventions for Pain

- **Activity modification for musculoskeletal pain.** You can make some changes to decrease this type of pain. For example, you can make changes to your wheelchair or start using a sliding board. You can also change how you push your wheelchair and how you do transfers. You can also change the way you do pressure relief maneuvers. Exercises that strengthen and balance your joints can also help reduce this type of pain. For more information, see the MSKTC factsheet **Pain after Spinal Cord Injury: Activity Modification for Musculoskeletal Pain.**
- **Physical therapy.** This type of therapy is for musculoskeletal pain. Stretching and range of motion exercises may help relieve pain due to muscle tension. Exercises that strengthen weak muscles can restore balance in painful joints and reduce pain. Hands-on techniques that mobilize the soft tissues and joints can help restore movement and reduce pain.
- **Therapeutic massage.** This type of massage treats musculoskeletal pain due to muscle tightness and imbalance.
- **Acupuncture.** This treatment is for musculoskeletal pain. A provider inserts tiny needles into the skin at specific points on the body. Some believe this method works by stimulating the body's pain control system or by blocking the flow of pain.
- **Transcutaneous electrical nerve stimulation (TENS).** TENS can treat musculoskeletal pain. With this treatment, electrodes on the surface of the skin send low levels of electrical current into your body. The current blocks signals from areas with nerve damage that causes pain.
- **Transcranial electrical stimulation.** This can treat nerve pain. With this treatment, electrodes on the scalp deliver electrical stimulation to the parts of the brain that may help to reduce pain.



Psychological Treatments for Pain

People can learn to use psychological techniques to help them manage their pain better so it doesn't take over their lives. Psychological treatments can be helpful for both musculoskeletal pain and nerve pain. Psychologists trained in pain management can help with techniques shown to be effective in reducing the intensity and impact of pain. Things you do yourself to manage your pain are known as self-management techniques. These treatments include the following:



- **Breathing exercises.** Slow and control your breathing by breathing in for 3 seconds and breathing out for 7 seconds. This can help you manage those times when your pain is worse.
- **Relaxation techniques and biofeedback.** These techniques teach you how to reduce pain from muscle tension. They also help with “mental tension” due to pain.
- **Visual imagery.** With these techniques, you will view a series of images to help change your perceptions and behaviors related to pain. You may listen to recordings that teach you how to think about different images; or you may use a virtual reality headset.
- **Mindfulness.** Mindfulness involves focusing on the present moment or the present experience. This technique teaches you how to separate an event (like pain) from the emotions associated with it (like sadness or stress) and be less distracted by it. It may help you to cope better with pain. You can practice mindfulness in many ways. Examples include meditating, focusing on sensations as you move, and doing breathing exercises.
- **Self-hypnosis training.** With self-hypnosis, people achieve a state of deep physical and mental relaxation which allows them to detach from their pain. This technique can help reduce chronic pain in some people.
- **Cognitive restructuring.** Learning how to think differently about your pain and its effects can lead to changes in brain activity. This, in turn, can change the experience of pain. For example, some people focus on their pain and feel helpless about the experience. Pain may interfere less in their lives if they stop focusing on their pain and learn techniques to help them feel less helpless.
- **Psychotherapy.** Therapy can help you identify goals and increase the joy and meaning in your life. This, in turn, can help reduce pain. Therapy can also help if you have a lot of anxiety associated with pain.



Medicines

There are many different medicines to treat pain. Most of the medicines listed below have shown some success in reducing pain, but none completely eliminate pain consistently. All may have side effects, some of which can be serious. Talk to your doctor about all side effects. Sometimes a combination of medicines works better than a single medicine.

- **NSAIDs.** NSAIDs, or nonsteroidal anti-inflammatory drugs, include aspirin; ibuprofen, such as Motrin® and Advil®; and naproxen. People take them for musculoskeletal pain. Side effects may include an upset stomach or bleeding problems. Some NSAIDs are topical treatments. An example is ketorolac (Voltaren Gel®). You can apply them directly to the skin in areas where you have pain. Topical NSAIDs have fewer side effects than those taken by mouth.
- **Injectable Steroids.** Doctors inject these medicines into joints and in the area near tendons. They treat musculoskeletal pain caused by inflammation. An example is triamcinolone (Kenalog®).
- **Antiseizure medicines.** These medicines treat nerve pain. Side effects may include dizziness, sleepiness, and swelling in the leg. Examples include gabapentin (Neurontin®), pregabalin (Lyrica®), and oxcarbazepine (Trileptal®).
- **Antidepressants.** These medicines treat nerve pain and depression. One type is selective serotonin norepinephrine reuptake inhibitors (SSNRIs). These include duloxetine (Cymbalta®) and venlafaxine (Effexor®). A second type is tricyclic antidepressants. These include amitriptyline (Elavil®) and nortriptyline (Pamelor®). SSNRIs may cause nausea. Side effects for tricyclic antidepressants are dry mouth, sleepiness, and constipation.



- **Opioids.** These medicines are for severe musculoskeletal pain right after an injury. Examples include morphine and oxycodone. These medicines are habit forming. Because of this, doctors do not often recommend using them long term. They have many side effects and risks. These include constipation, confusion, slowed breathing, and death due to overdose. Sometimes other treatments, such as seizure medicines and antidepressants, can't control nerve pain. In that case, your doctor may consider trying low-dose opioids with close medical follow-up.
- **Muscle relaxers and medicines for spasticity.** These medicines treat musculoskeletal pain and pain due to spasms. They include diazepam (Valium®), baclofen (Lioresal®) and tizanidine (Zanaflex®), all of which can be taken by mouth. In addition, baclofen can be delivered directly to the spinal cord through an implanted pump (see "Intrathecal or baclofen pumps" below). All of these drugs can cause sleepiness, confusion, and other side effects.
- **Neurotoxin injections.** Doctors use these medicines to treat localized pain from the spasms caused by spasticity. Examples include botulinum toxins (Botox® and Dysport®) and alcohols such as phenol.
- **Topical local anesthetics.** These medicines treat pain that occurs when skin is lightly touched. This is known as allodynia. An example is lidocaine or Lidoderm®.
- **Cannabis.** Research looking at cannabis use after SCI is in the early stages. Studies to date have not shown that cannabis products are effective for treating pain. We need more research to find out if cannabis is a safe and effective treatment after SCI. Smoking cannabis is not recommended due to the risks that come with inhaling smoke.



Surgical Treatments

Intrathecal or baclofen pumps can treat pain due to muscle spasms with baclofen. A pump that contains baclofen is surgically placed under the skin in the abdomen. The pump delivers the medicine directly to the surface of the spinal cord.

Prevention and Self-Care

There are some steps you can take to help prevent pain after SCI. They include:

- **Get treatment for health problems.** Your overall health can have a big impact on pain. Infections, bowel problems, skin problems, sleep problems, and spasticity can make pain worse or harder to treat. Keeping yourself as healthy as possible can help reduce pain.
- **Try to exercise as much as you can.** Regular exercise can reduce pain and improve mood and health. It can also be fun and distract you from your pain. Your health care provider can help you choose physical activities that are safe and appropriate for you. See the "Pain after Spinal Cord Injury: Activity Modification for Musculoskeletal Pain" factsheet.
- **Maintain a healthy weight.** Being overweight is hard on your shoulders, wrists, hips and knees and can lead to musculoskeletal joint pain. Achieving a healthy weight can help reduce musculoskeletal joint pain.
- **Get treatment for depression.** Depression can make pain worse. Getting treatment for depression can help you cope with chronic pain and improve your quality of life. The best treatment is counseling and medicine. Activity and exercise can also improve mood and reduce depression.



- **Reduce stress.** Stress can make pain worse or make it harder to cope with. You can learn to manage stress through counseling. You can also learn techniques to help you reduce stress and tension. These include relaxation training, biofeedback, and hypnosis. Exercise also helps to reduce stress.
- **Distract yourself.** Distraction is one of the best methods for coping with chronic pain. Taking part in fun and meaningful activities can help reduce pain; it can also help you feel more in control of your life, especially when pain is at its worst. When you are bored and inactive, you tend to focus more on your pain; this can make your pain feel worse.
- **Keep a record.** Everyone's pain is different. Keep a record of what makes you feel better and what makes your pain worse. Understanding what affects your pain will help you and your doctor to find effective ways to reduce your pain.
- **Get a wheelchair seating evaluation.** Poor posture and improper seating can cause serious pain. Ask a physical therapist (PT) or occupational therapist (OT) who specializes in wheelchair seating to assess your seating. If you use a manual wheelchair, you should get a high-strength chair. The chair should be made of the lightest material available. This is usually aluminum or titanium. You should be able to customize the chair fully. Talk to a PT or OT about the proper technique for propelling a wheelchair. (For more information, see the **"Pain after Spinal Cord Injury: Activity Modification for Musculoskeletal Pain"** factsheet.)
- **Do not use alcohol to ease your pain.** Using alcohol as a pain medicine can lead to alcohol abuse and other serious problems. There are some medicines you should not mix with alcohol. Ask your doctor about drinking alcohol, and always read the labels on your prescriptions.



Finding Help

If you have pain, it is important to get treatment for it. The best source of help would be a doctor and a psychologist who are familiar with SCI and pain management, working together.

If you do not have access to such experts, the next best option is to seek help from a multidisciplinary pain clinic. These clinics have both doctors and psychologists available. Work closely with a health care provider with whom you are comfortable and who understands your condition.

Chronic pain is not hopeless. Try not to become discouraged if one treatment doesn't work. Be open to trying a variety of different techniques. Complete relief from pain may not be possible but living better in spite of pain is a realistic goal.



Resources

- Spinal Cord Injury Research Evidence (SCIRE) Community: <https://community.scireproject.com/topics/browse-by-area/pain/>
- Pain Management Network: <https://aci.health.nsw.gov.au/chronic-pain/spinal-cord-injury-pain>
- CareCure Community moderated SCI forums, including a pain forum: <http://sci.rutgers.edu/forum/>



Authorship

Pain After Spinal Cord Injury was originally developed by J. Scott Richards, PhD, Trevor Dyson-Hudson, MD, Thomas N. Bryce, MD, and Anthony Chiodo, MD, in collaboration with Model Systems Knowledge Translation Center (MSKTC). *Pain After Spinal Cord Injury* was revised in 2023 by Thomas N. Bryce, MD, Lisa Haubert, DPT, Jeanne M. Zanca, PhD, J. Scott Richards, PhD, and Jeffrey Berliner, DO, in collaboration with the MSKTC.

Portions of this document were adapted from materials developed by the University of Alabama at Birmingham Spinal Cord Injury Model System, University of Michigan Model SCI Care System, Northwest Regional Spinal Cord Injury System, and Craig Hospital.

Source: The content in this factsheet is based on research and/or professional consensus. This content has been reviewed and approved by experts from the Spinal Cord Injury Model Systems (SCIMS) centers, funded by the National Institute on Disability, Independent Living, and Rehabilitation Research (NIDILRR).

Disclaimer: This information is not meant to replace the advice of a medical professional. You should consult your health care provider about specific medical concerns or treatment. The contents of this factsheet were developed under a grant (number H133A110004) from the U.S. Department of Education (ED), National Institute on Disability and Rehabilitation Research (NIDRR). It was updated under a grant (number 90DPKT0009) from the NIDILRR. NIDILRR is a Center within the Administration for Community Living (ACL), U.S. Department of Health and Human Services (HHS). The contents of this factsheet do not necessarily represent the policy of NIDILRR, ACL, HHS, or ED and you should not assume endorsement by the federal government.

Recommended citation: Bryce, T. N., Haubert, L., Zanca, J. M., Richards, J. S., & Berliner, J. (2023). *Pain after Spinal Cord Injury*. Model Systems Knowledge Translation Center. <https://msktc.org/sci/factsheets/pain-after-spinal-cord-injury>.

Copyright © 2023 Model Systems Knowledge Translation Center (MSKTC). May be reproduced and distributed freely with appropriate attribution. Prior permission must be obtained for inclusion in fee-based materials.



Pain after Spinal Cord Injury: Activity Modification for Musculoskeletal Pain

May 2023

<https://msktc.org/sci/factsheets>

SCI Factsheet

This factsheet includes tips on how to adjust your activity to help with pain after SCI.

Musculoskeletal pain may be due to injury or overuse of muscles or arthritis of joints. It is a common problem for all people as they get older, including those with SCI. However, you can adjust your activity in different ways to help reduce or prevent musculoskeletal pain. These activity modifications include:

Exercise

- Most people can benefit from a fitness program that includes resistance training using weights or elastic bands for the muscles that stabilize the shoulder. Such exercise will help prevent shoulder pain and help to treat pain from overuse of these muscles. Strong muscles are much less likely to get hurt. Talk with your doctor or therapist about starting a resistance training program.
- For aerobic exercise, you can use equipment that works the upper body. This may include a stationary bike powered by the arms or a hand-cranked sports wheelchair. You can box with a speed bag. You can also use an activity monitor as you gradually increase your manual wheelchair pushing throughout the day for exercise.
- Make sure your back and shoulder muscles are strong enough to support wheeling and transferring. It is important that your muscles on both your left and right sides are as equal in strength as possible. Ask your physical or occupational therapist to evaluate you. They can prescribe strengthening exercises if you need them.
- See the MSKTC factsheet on Exercise after Spinal Cord Injury (see the Reference Section below) for more information including specific recommendations on exercise.



The Model Systems Knowledge Translation Center works with Spinal Cord Injury Model System (SCIMS) centers to provide free research-based rehabilitation resources for people living with spinal cord injury (See <https://msktc.org/sci> for more information). This factsheet has been approved by experts from the SCIMS centers.

Using a Wheelchair

- Constant pushing of wheel rims can cause musculoskeletal pain. Think about getting a power or power-assist wheelchair or power-assist add-on for your wheelchair if you
 - have major pain in the upper limb (shoulder, elbow, or hand),
 - have tetraplegia (or quadriplegia),
 - have a prior injury to an upper limb,
 - are overweight,
 - are older, or
 - live in a challenging environment such as on a steep hill or near rough terrain.



- If you use a manual wheelchair, make sure it is the lightest model you can afford or that your insurer will pay for. Such models are made from aluminum, titanium, or carbon fiber. Lighter models give you less weight to push around. You can often customize these chairs to make it easier for you to propel them.
- If you use a manual wheelchair, reduce the number of strokes you use as you travel. Rather than quick, short pushes, use long, smooth strokes.
- If you use a manual wheelchair, make sure it is in good shape. Also make sure it is set up in a way that lets you get around with little effort. Ask your therapist to check whether your seat is in the right position relative to your rear axle. Also ask them to check that the chair and cushion together give you good stability.
- Ask a physical therapist (PT) or occupational therapist (OT) who specializes in wheelchair seating to evaluate your wheelchair seating, your posture, and your pushing technique. Do so at least once every 2 years. Your needs, habits, or activities may change over time.
- Choose air filled tires and keep your tires well inflated to lessen rolling resistance.
- Wheel your chair over concrete and linoleum rather than through sand, grass, or carpet, when possible. The reduced resistance to your wheels will lessen the load on your arms.
- See the Preservation of upper limb function following spinal cord injury: A clinical practice guideline for health-care professionals and MSKTC factsheet The Manual Wheelchair: What the Spinal Cord Injury Consumer Needs to Know (see the Reference Section below) for more information.



Shoulder Health

- Limit arm/hand tasks, especially tasks that involve lifting any load higher than your shoulder. Let someone else get that book off a high shelf for you.
- If you can, avoid doing tasks over and over that require you to bring your hand higher than your shoulder. You may need to reorganize your house. Talk with your occupational therapist about ways to do so.
- Avoid lifting heavy loads. If you can't get someone else to do the heavy lifting, hold the load close to your chest rather than at the end of an outstretched arm.
- Avoid doing push-up pressure reliefs or weight shifts; they can harm your shoulder joint. Instead, do side-to-side or forward-lean pressure reliefs. Work with a therapist to learn the proper technique for these methods. See the MSKTC factsheet How to Do Pressure Reliefs (Weight Shifts) (see the Reference Section below) for more information.



Transfers

- How you transfer makes a difference. Work with a therapist to learn transfer techniques that can minimize pain.
- The heaviest thing you will lift is yourself. Reduce the number of transfers you do each day. Do them in a way that limits your risk of injury and avoids pain.
- Transferring from a high point to a lower one is not as hard on your wrists, elbows, and shoulders as transferring from a low point to a higher one. It is better to make two level transfers rather than one downhill transfer followed by one uphill transfer.
- Use a transfer board and other assistive devices (such as lifts) when doing a transfer.
- When doing a transfer, use a handgrip if one is present rather than putting your hand on a flat surface to avoid bearing weight through a bent wrist. If a handgrip is not available, make a fist and push through your knuckles, keeping your wrist as straight (neutral) as possible.



- When doing a transfer, keep your hands as close to your body as possible. Your arms should be straight up and down, and your weight should hang between them.
- Alternate which one of your arms is the lead arm when doing a transfer. The lead and trailing arms use different muscles during a transfer. Alternating the arms keeps your muscles balanced.
- Maintain a healthy weight. Being overweight is hard on your shoulders, arms, and wrists when you do transfers or push your wheelchair.
- See the MSKTC factsheets on Transfers (see the Reference Section below) for more information.

References

- Paralyzed Veterans of America Consortium for Spinal Cord Medicine. (2005). Preservation of upper limb function following spinal cord injury: A clinical practice guideline for health-care professionals. *Journal of Spinal Cord Medicine*, 28(5), 433–470.
- <https://msktc.org/sci/factsheets/exercise-after-spinal-cord-injury>
- <https://msktc.org/sci/factsheets/how-do-pressure-reliefs-weight-shifts>
- <https://msktc.org/sci/factsheets/manual-wheelchair-what-spinal-cord-injury-consumer-needs-know>
- <https://msktc.org/sci/factsheets/safe-transfer-technique>
- <https://msktc.org/sci/infographics/safe-and-independent-manual-wheelchair-transfers>
- <https://msktc.org/sci/infographics/safe-and-independent-power-wheelchair-transfers>
- <https://msktc.org/sci/online-course/safe-wheelchair-transfer-training>



Authorship

Pain After Spinal Cord Injury: Activity Modification for Musculoskeletal Pain was originally developed by J. Scott Richards, PhD, Trevor Dyson-Hudson, MD, Thomas N. Bryce, MD, and Anthony Chiodo, MD, in collaboration with Model Systems Knowledge Translation Center (MSKTC). It was revised in 2023 by Thomas N. Bryce, MD, Lisa Haubert, DPT, Jeanne M. Zanca, PhD, J. Scott Richards, PhD, and Jeffrey Berliner, DO, in collaboration with the MSKTC.

Portions of this document were adapted from materials developed by the University of Alabama at Birmingham Spinal Cord Injury Model System, University of Michigan Model SCI Care System, Northwest Regional Spinal Cord Injury System, and Craig Hospital.

Source: The content in this factsheet is based on research and/or professional consensus. This content has been reviewed and approved by experts from the Spinal Cord Injury Model Systems (SCIMS) centers, funded by the National Institute on Disability, Independent Living, and Rehabilitation Research (NIDILRR).

Disclaimer: This information is not meant to replace the advice of a medical professional. You should consult your health care provider about specific medical concerns or treatment. The contents of this factsheet were developed under a grant (number H133A110004) from the U.S. Department of Education (ED), National Institute on Disability and Rehabilitation Research (NIDRR). It was updated under a grant (number 90DPKT0009) from the NIDILRR. NIDILRR is a Center within the Administration for Community Living (ACL), U.S. Department of Health and Human Services (HHS). The contents of this factsheet do not necessarily represent the policy of NIDILRR, ACL, HHS, or ED and you should not assume endorsement by the federal government.

Recommended citation: Bryce, T. N., Haubert, L., Zanca, J. M., Richards, J. S., & Berliner, J. (2023). *Pain after Spinal Cord Injury: Activity Modification for Musculoskeletal Pain*. Model Systems Knowledge Translation Center <https://msktc.org/sci/factsheets/pain-after-spinal-cord-injury-activity-modification-musculoskeletal-pain>.

Copyright © 2023 Model Systems Knowledge Translation Center (MSKTC). May be reproduced and distributed freely with appropriate attribution. Prior permission must be obtained for inclusion in fee-based materials.



Personal Care Attendants and Spinal Cord Injury

August 2020

www.msctc.org/sci/factsheets

SCI Factsheet

This fact sheet offers suggestions on finding, interviewing, funding, and managing a personal care attendant.

What is a personal care attendant?

A personal care attendant, or PCA, is someone paid to help you with some or all of your self-care and other activities that you need for daily living after spinal cord injury (SCI).

- “Personal Assistant” and “Personal Assistant Service” are other terms that refer to similar personal care services.

Do I need a PCA?

You may benefit from a PCA if you need help with daily needs. A few ways a PCA might help you include:

- Meeting basic daily care needs.
- Making the best use of your time and energy to get through a full day of activities. For many people with higher levels of SCI, a PCA can make it easier to work or go to school.
- Helping to minimize pain or fatigue that you have when doing daily activities without help.
- Adapting to any decline in your abilities to do daily activities as you age.

What help does a PCA provide?

- Self-care. This often includes help with bathing, grooming, dressing, feeding, and bladder and bowel management. It may also include help with other tasks, like keeping your lungs clear of secretions.
- Mobility. This may include help with transfers, pressure relief movements, using a wheelchair, and driving.
- Set-up. This may include help with setting up assistive devices or other items around you, such as a computer, so that you can do activities by yourself.
- Light housework. This may include help with tasks like preparing food, washing dishes, doing laundry, and cleaning.

Is it better to rely on care from a PCA or a family member?

Each person’s situation is different. It is common to get help from family members. You may also prefer to have family help with ongoing daily needs because it works best for your situation or you simply feel more comfortable getting help from someone in your family.

- Some states pay a family member if you prefer a family member to a PCA.

Getting help from family for some or all of your daily needs can have benefits, but there may also be downsides. It is important to consider your needs as well as the needs of your family members when making a plan for your care.

The Spinal Cord Injury Model System Program is sponsored by the National Institute on Disability, Independent Living, and Rehabilitation Research, Administration for Community Living, U.S. Department of Health and Human Services. (See <http://www.msctc.org/sci/model-system-centers> for more information).



If a family member is providing your daily care, it is a good idea for you and your family member to talk with a psychologist, counselor, or social worker for guidance. Here are some topics you might discuss:

- Managing stress.
- Keeping family roles separate from caregiver roles.
- Reducing the burden on your family member, such as arranging time off from caregiving duties.

Some of the benefits of relying on a PCA rather than a family member include:

- It may help to avoid blurring the roles of caregiver and family member.
- It may help reduce stress on the relationship, especially if the caregiver is a partner or spouse.
- It may give you and your family member more independence. This may give you both more opportunities to live active, productive lives.
- It may help prevent a partner or spouse from becoming resentful, depressed, or upset if they are having difficulty meeting your needs.

How do I find a PCA?

- Contact your state Department of Rehabilitation Services. Many states offer programs that can help you find a PCA. Some states will also help to pay for a PCA.
- Contact your local Center for Independent Living (CIL). Each state has at least one CIL. Your local CIL offers many services, and CILs can often provide you with information and referrals related to any personal care services in your area.
- If you have private insurance or workers' compensation insurance, contact customer service to find out if your coverage includes PCA services. Your insurance provider may have a service to help find a PCA.
- Use social media and the web. Social media posts let friends and family know you are looking for a PCA. Someone in your social network may be interested, or they may know someone. Also, some websites let you place ads for help.
 - Be careful when you are online. Avoid giving out personal information until after you are comfortable with the person receiving it. You might create a separate email account or web-based voicemail box so that you can connect with people without sharing your personal information.
- Post a flyer in places where people in the personal assistance field may see it. For instance, you might put a flyer on a hospital or skilled nursing facility bulletin board. You might post a flyer at a local college that offers nursing, occupational therapy, or physical therapy courses.
- Put a classified ad in your local newspaper. If you place an ad, do it on weekends because that is your best chance to reach the most people.
- Contact a local agency or business that offers personal assistance services. You can search online using terms like "personal assistant," "personal care," "caregiver," or "home health services."
 - Always check reviews and take other steps to find out if the agency or business is trustworthy.
 - Some agencies limit the types of services offered. This may include limits on "medical" services, such as bowel and bladder management.



What is the first step in hiring a PCA?

The first step is to know your needs so that you can clearly explain them to people who are interested in the job. Make a list of all activities that you expect your PCA to help you do. List the time it usually takes to do each activity along with the total time it usually takes to complete all activities.

What do I do when someone is interested?

Talk to the person on the phone. Give the person a brief overview of the type of help you need. Then, schedule an interview if both of you are still interested.

What do I need to know about interviewing?

Have a plan

Prepare a list of questions to ask before you set up any interviews. Think of questions that will help you find the best match to meet your personal needs. Ask each person the same questions so you can judge everyone on equal terms. Here are only a few examples:

- What work experience do you have?
- Do you have references?
- Are you able to lift, push or pull things?
- Do you cook and do housework?
- Do you have a driver's license and reliable transportation?

Hints for interviewing

- You may prefer to conduct your first interview at home, but you can also do it over the phone or in a public location where you can talk privately.
- Clearly explain in detail every task that you need your PCA to do. Consider providing a written list as a visual aid during the interview.
- Explain your schedule and the importance of staying on schedule.
 - You may need a PCA in the morning, in the evening, or both. If both, make sure you talk about what tasks you do at specific times. You may need to decide if you want different PCAs for morning and evening or if you prefer a PCA who can work split shifts.
- Outline the education and training you will provide.
- Explain any rules you want them to follow. This might include not allowing smoking or limiting personal calls and texting. Also, explain what they should do if they are running late or cannot come to work.
- Describe the work environment. Make sure the person knows if you have pets or if you need the room to be a certain temperature.
- Talk about vacation and time off.
- Explain how you manage situations and payment when you need unscheduled services outside normal times.
- Invite the person to ask questions. Some tasks can be very personal. Answering questions can help them understand what is needed and feel more at ease with doing these tasks.
- Get to know each other. Questions and answers are only one part of an interview. Interviews are also a good way to find out if you feel comfortable with each other and get along well.



What is the first step in hiring a PCA?

The first step is to know your needs so that you can clearly explain them to people who are interested in the job. Make a list of all activities that you expect your PCA to help you do. List the time it usually takes to do each activity along with the total time it usually takes to complete all activities.

What do I do when someone is interested?

Talk to the person on the phone. Give the person a brief overview of the type of help you need. Then, schedule an interview if both of you are still interested.

What do I need to know about interviewing?

Have a plan

Prepare a list of questions to ask before you set up any interviews. Think of questions that will help you find the best match to meet your personal needs. Ask each person the same questions so you can judge everyone on equal terms. Here are only a few examples:

- What work experience do you have?
- Do you have references?
- Are you able to lift, push or pull things?
- Do you cook and do housework?
- Do you have a driver's license and reliable transportation?

Hints for interviewing

- You may prefer to conduct your first interview at home, but you can also do it over the phone or in a public location where you can talk privately.
- Clearly explain in detail every task that you need your PCA to do. Consider providing a written list as a visual aid during the interview.
- Explain your schedule and the importance of staying on schedule.
 - You may need a PCA in the morning, in the evening, or both. If both, make sure you talk about what tasks you do at specific times. You may need to decide if you want different PCAs for morning and evening or if you prefer a PCA who can work split shifts.
- Outline the education and training you will provide.
- Explain any rules you want them to follow. This might include not allowing smoking or limiting personal calls and texting. Also, explain what they should do if they are running late or cannot come to work.
- Describe the work environment. Make sure the person knows if you have pets or if you need the room to be a certain temperature.
- Talk about vacation and time off.
- Explain how you manage situations and payment when you need unscheduled services outside normal times.
- Invite the person to ask questions. Some tasks can be very personal. Answering questions can help them understand what is needed and feel more at ease with doing these tasks.
- Get to know each other. Questions and answers are only one part of an interview. Interviews are also a good way to find out if you feel comfortable with each other and get along well.



Making your choice

Choose the person who best fits your needs. If you are having a hard time deciding, make a checklist of your needs and then list the person that you think will best fit each need. You also want to think about the qualities of a “good” employee in any job.

- Do you think the person provided good references?
- Do you think the person is dependable and will be on time?
- Do you think the person is trustworthy and honest?
- Do you think the person can follow instructions?
- Do you think the person is friendly and someone you want to spend time with?

Do a background check

It is important to do a background check to find out if the person has a criminal history before making a job offer. The simplest way is to pay a service to do a background check. You can find many background check agencies online. You might also ask your local law enforcement for advice on how to best do a background check.

What education and training do I need to provide?

Most PCA education and training is done through hands-on work with you, even if you find a PCA with a lot of experience. This means it is up to you to work with your PCA through each task to provide the education and training needed to meet your daily needs.

- The Model Systems Knowledge Translation Center offers educational factsheets and other resources on many SCI topics. You might use them to help educate and train your PCA to meet your needs.

How do I pay for a PCA?

PCAs are usually paid by the hour. The cost per hour varies depending on the cost of living in your area.

Few people can pay out-of-pocket for PCA services, so you might brainstorm options to help offset or supplement your PCA’s pay. For example, a trusted PCA might be offered room and board or use of a vehicle in exchange for PCA services.

- Make sure you plan your budget carefully if you intend to pay out-of-pocket for some or all of the cost of a PCA.
- Talk with an accountant about tax-related questions about out-of-pocket costs.

Suggestions for getting help to pay for PCA

- Some states help pay for PCAs through medical assistance programs or with funds from the state’s Department of Rehabilitation Services.
- Some Area Agencies on Aging help pay for PCAs. Check with your local agency to find out what resources are available.
- In some cases, private insurance and workers’ compensation insurance will pay for a PCA. Most insurance cards include a customer service number that you can call to ask about PCA coverage.
- Contact a local social worker to find out if any options are available in your area.



What can I do to help keep a PCA?

It can be hard to keep a good PCA even under the best conditions, but you can make sure that your PCA is working in a pleasant environment. Here are a few suggestions.

- Develop a professional, pleasant relationship. Humor can help create a more relaxed work environment.
- Be polite and show appreciation. Say “thank you” and “please.” Pay raises or small bonuses are always welcome.
- When making requests for a task to be done a certain way, explain the reasons for that request. For example, you may need an object placed in a specific location so you can reach it when your PCA is away, or you may ask for strict handwashing to prevent you from getting infections that will send you to the hospital. Sharing the reasons for your requests can prevent you from being thought of as “picky” and provides an opportunity to show how much you value your PCA’s efforts. This may increase the likelihood of your requests being fulfilled.
- Do as much for yourself as you can. This shows your PCA that you are partners in your care.
- Be assertive without being rude. Although you are in charge of your personal care, treat your PCA like a person and not like a servant.
- Avoid major changes in your routine that disrupt the work schedule or waste time.
- Respect your PCA’s views, opinions, and personal life. Avoid talking about “hot topics” that may cause conflict such as religion and politics.
- Be honest about the hours worked and pay on time.
- Do not ask for special favors or expect your PCA to work for free.
- Avoid overworking your PCA. When possible, use more than one PCA. If you rely on one PCA, find ways to give your PCA time off.
- Be flexible and understanding. Do not be too strict. Understand that mistakes happen. Also, keep in mind that sometimes people cannot avoid being late or sick.

What do I do if I experience abuse?

No form of abuse is acceptable. This includes you abusing others or others abusing you.

Anyone can be an abuser. It might be a health care provider, a friend, or a family member. Here are a few types of abuse experienced by some people with SCI.

- Verbal or emotional abuse includes non-physical behaviors. This may include insults, threats, or excessive yelling or screaming as a way to control you.
- Physical abuse is any intentional use of physical touch to cause fear, pain, injury, or trauma. This may include shoving, hitting, or strangling.
- Sexual abuse is any unwanted or improper sexual advances or activity. This may include unwanted sexual touch or sexual assault (rape).
- Abandonment is being intentionally left alone without making sure that your basic needs are met. This may include being left in the bed with no way to get out and with no access to food, drink, or the bathroom.



- Financial abuse is when there is money stolen or someone takes control over another person's money for his or her own personal benefit.
- Neglect is withholding necessary services to maintain your health and wellbeing. This may include being denied access to proper food choices, hygiene care, necessary assistive devices, medication, or healthcare.

It is very important to have a plan in place to act quickly if you experience abuse. Here are some potential action steps to take if you are experiencing any form of abuse:

1. Call 9-1-1 anytime you have an emergency or feel in danger of harm.
2. To report abuse and get advice on actions to take, contact local entities like your local Adult Protective Services, Social Security office, Agency on Aging, Department of Social Services, or law enforcement.
 - You can also get support and advice from the National Domestic Violence Hotline (1-800-799-7233).
3. Tell a family member or someone else you trust. You might also set up a "safe word" that secretly tells the person you trust that you need help.
4. You might set up smart home devices like cameras, locks, and smart speakers to help prevent crime and offer you added home security when needed.
 - A touch pad combination lock with changeable codes may be another option in place of smart locks.

Additional Resources

Links to online resources can change, but you can search online for these recommended resources on finding and managing a PCA.

- How to Successfully Hire and Manage a Personal Care Assistant for People with Spinal Cord Injury – published by Shepherd Center.
- Managing Personal Assistants: A Consumer Guide – published by the Paralyzed Veterans of America.
- A Step-by-Step Guide to Training and Managing Personal Assistants: Consumer Guide – published by the Research and Training Center on Independent Living (University of Kansas)
- Personal Care Assistants: How to Find, Hire & Keep - published by Craig Hospital
- Personal Care Assistance: How Much Help Should I Hire? - published by Craig Hospital

Authorship

Personal Care Attendants and Spinal Cord Injury was developed by Phil Klebine, MA, Casey Azuero, PhD, MPH, Kelli Arthur, MSW, LICSW, and Jeanne Zanca, PhD, MPT, in collaboration with the Model Systems Knowledge Translation Center.

Source: The content in this factsheet is based on research evidence and/or professional consensus and has been reviewed and approved by an editorial team of experts from the Spinal Cord Injury Model Systems (SCIMS), funded by the National Institute on Disability, Independent Living, and Rehabilitation Research (NIDILRR).

Disclaimer: This information is not meant to replace the advice of a medical professional. You should consult your health care provider regarding specific medical concerns or treatment. The contents of this factsheet were developed under a grant from the National Institute on Disability, Independent Living, and Rehabilitation Research (NIDILRR grant number 90DP0082). NIDILRR is a Center within the Administration for Community Living (ACL), Department of Health and Human Services (HHS). The contents of this factsheet do not necessarily represent the policy of NIDILRR, ACL, or HHS, and you should not assume endorsement by the federal government.

Copyright © 2020 Model Systems Knowledge Translation Center (MSKTC). May be reproduced and distributed freely with appropriate attribution. Prior permission must be obtained for inclusion in fee-based materials.



Pregnancy and Women with Spinal Cord Injury

May 2015

www.msctc.org/sci/factsheets

SCI Fact Sheet

This fact sheet helps women prepare for pregnancy, labor and delivery after a spinal cord injury. It also gives tips on how you can work with your health care team to keep you and your baby healthy.

Are you thinking about getting pregnant?

Having a spinal cord injury (SCI) does not affect your ability to naturally become pregnant, carry, and deliver a baby, so your decision to have children is made in much the same way as anyone else. You consider the demands and challenges of parenting and how you might manage them. Here are other facts to consider when deciding whether or not you want to have children.

- Women with all levels of injury have had children after injury. You should also be able to if you choose.
- The positive aspects of parenting usually outweigh the difficulties.
- www.lookingglass.org and www.disabledparents.net are good online resources for women with SCI who are pregnant or want to get pregnant.

What do I do if I am pregnant or want to get pregnant?

Here is a checklist of things to do help you plan for a healthy pregnancy.

- ✓ **Get a complete GYN exam.** This will give you the opportunity to get pre-conception counseling, Pap smear testing, assessment of immunizations, family history, as well as screening for genetic testing.
- ✓ **Talk to a rehabilitation doctor who knows about women's health after SCI.** This doctor, sometimes known as a physiatrist (pronounced fizz-ee-a-trist), can talk with you about your injury and explain what it means for your pregnancy, labor, and delivery. A physiatrist can also help you find an obstetrician (pronounced ob-ste-trish-in) or other medical specialists you may need during your pregnancy.
- ✓ **Get your medicines checked.** Many prescription and over-the-counter medicines are not to be taken if you are pregnant or want to get pregnant. When you go to the obstetrician, take *all* of your medicines with you. You may need to adjust your medicines to keep your baby healthy.
- ✓ **Get a urology check-up.** The growing baby will put pressure on your bladder. Getting a complete check-up of your urinary tract (kidneys, bladder, ureters) before you get pregnant is important. You and your obstetrician will use the test results to plan and prepare as your body changes during pregnancy.
 - **NOTE:** Tell your doctor if you are pregnant or think you might be pregnant. Some tests, such as x-rays, can harm your baby.

The Spinal Cord Injury Model System is sponsored by the National Institute of Disability and Rehabilitation Research, U.S. Department of Health and Human Services' Administration for Community Living. Opinions expressed in this fact sheet are not necessarily those of the granting agency.

For more information, contact your nearest SCI Model System. For a list of SCI Model Systems go to <http://www.msctc.org/sci/model-system-centers>

What happens during pregnancy?

Your injury does not impact your baby. Your baby will develop as all babies do. This means you need to follow the advice of your obstetrician to take care of your baby. You may also have the same common discomforts of pregnancy that other women have.

- Headaches
- Body aches and pains
- Numbness or tingling
- Fatigue
- Nausea and vomiting
- Dizziness
- Need to urinate often
- Heartburn and indigestion
- Swelling in the feet and ankles
- Hemorrhoids
- Shortness of breath
- Bleeding gums
- Congestion or nose bleeds
- Constipation



However, your risk for secondary conditions related to your SCI may increase as you progress during pregnancy. This risk does not mean that you should not get pregnant. It simply means that you need to work with your obstetrician to take steps to prevent secondary conditions if you can and manage problems that do develop.

- You and your obstetrician may need to call on other specialists during your pregnancy. Some specialist might include a urologist, respiratory therapist, physical therapist, and occupational therapist.
- If you have had posture changes due to a curved spine, broken pelvis, or dislocated hip, there may be less room for your baby to grow to full term.

It is impossible to predict when or if secondary conditions will develop during your pregnancy. Some may occur early on in pregnancy and go away in time. Others may continue to be a problem throughout pregnancy and delivery. However, below is a breakdown of what you might expect with each trimester.

First trimester: Week 1 through 13 is the start of many changes with your body

- **Autonomic dysreflexia (AD).** Headache and nausea are common during pregnancy, but a pounding headache and nausea may also be signs of AD. You are at risk for AD at any time if your injury level is T6 or above. You and your obstetrician should have a plan in place to manage AD if it develops.
- **Urinary Tract Infection (UTI).** You are at risk for a UTI at any time. Your obstetrician may prescribe an antibiotic to prevent an infection during your pregnancy. The UTI must be treated right away if you get one because the infection can trigger early labor as your pregnancy progresses.
- **Bowel Management.** Hormone and iron supplements are usually prescribed by your obstetrician. These medications may impact your bowel program in one of two ways.
 - Constipation - If you are constipated, you should ask your obstetrician about drinking more water, eating foods that are higher in insoluble fiber, or taking a stool softener or laxative.
 - Diarrhea - If you have diarrhea, you should ask your obstetrician about drinking more water, eating food that are higher in soluble fiber, not taking a stool softener or laxative (if effective, you may need to adjust your dose until your stool is of proper consistency), and doing your bowel program more often if you are having accidents.
 - Diarrhea may even be caused by an impaction (blockage) of stool. This may be the case if you have recently had hardened, stone-like stool or little results from your last bowel movement.

Second trimester: Week 14 through 26 is a time of weight gain because your baby is growing quickly

- **Daily activities.** Weight gain makes it hard to do some things like you did before you got pregnant. For example, transfers or pushing your wheelchair may be harder. You may get tired more quickly. You might talk with a physical or occupational therapist to find new ways to get everyday tasks done. Here are a few suggestions.
 - Make fewer transfers, use a sliding board to transfer, or get help from others.
 - Rent or buy a power wheelchair.
- **Bladder management.** A growing baby puts pressure on your bladder. Your bladder cannot hold as much urine as usual and may spasm.
 - Women who use intermittent catheterization will likely need to catheterize more often or switch to an indwelling catheter (Foley) during pregnancy.
- **Skin care.** Pressure ulcers are always a concern, but your risk for getting a pressure ulcer increases during pregnancy. Weight gain can change your posture and center of gravity to make it harder to lift your body to transfer without scraping your skin. Weight gain can also put more pressure on your bony areas when you are sitting or lying down. You might talk with a physical or occupational therapist to find new ways to get everyday tasks done. Here are a few suggestions.
 - Check your skin more often. Your obstetrician can also include skin inspections as part of your prenatal exams.
 - Do pressure relief much more often.
 - See the fact sheet, "Skin Care and Pressure Sores in Spinal Cord Injury" at <http://www.msctc.org/sci/factsheets/Skincare>.
- **Muscle spasms.** There is a chance you may have changes in muscles spasms. They may get worse if you normally have them, or you may develop muscle spasms if you normally do not have them.

- See the fact sheet, “Spasticity and Spinal Cord Injury”

Third trimester: Week 27 through 40 is when you and your baby continue to get bigger

- **Breathing.** Your growing baby pushes on your diaphragm. This can make it harder for you to breathe, take deep breaths and cough. You might talk with a respiratory therapist to find ways to improve your breathing. Here are a few suggestions.
 - Your obstetrician may suggest breathing exercises. If your injury is high on the spine, your obstetrician may need to test how well your lungs are working.
- **Blood flow.** Pressure from the growing baby can slow the flow of blood to your legs and feet, causing them to swell.
 - Talk to your obstetrician about medicine to help keep clots from forming if you have had blood clots in the past.
 - Talk to a physical or occupational therapist to see if range-of-motion exercises or changes in positioning can improve blood flow.
 - Prop your feet up as much as possible.
 - Wear compression support hose.
 - Get extra rest.

What happens during labor and delivery?

Women with SCI need to plan for labor and delivery in the same way as other women.

- Attend childbirth classes
- Get your nursery ready for the baby
- Know what to do when labor starts
- Get a car seat and know how to install it
- Pack your labor bag for the hospital
- Line up help for after the birth
- Stock up on diapers, wipes and other baby essentials
- Stock your fridge and pantry with groceries

Women with SCI may also have many of the common signs of labor.

- Water breaks or mucus leakage
- Feelings of fear and worry
- Diarrhea
- Unusual pain or backache
- Strong, regular contractions
- Tightening in your abdomen
- Breathing easier
- Pressure in the pelvis

You and your obstetrician need to plan for your delivery early in your pregnancy.

- You still need to pay close attention to issues with AD, UTI, bowel management, bladder management, skin care, muscle spasms, and blood flow.
- Take a tour of the labor, delivery, and patient rooms to make sure everything is fully accessible and meets your needs. Talk to hospital staff about any needs you will have.

Labor

A full-term pregnancy is 39 or 40 weeks, but it is best to start watching for signs of labor at about 28 weeks. At that point, your obstetrician might check your cervix weekly.

- Women with paraplegia can learn how to check for labor by feeling the uterus.
- Women with tetraplegia can talk with the obstetrician about a contraction monitor that you can use at home.
- Women with a T10 level of injury or above may not feel labor pain.
- Women with injuries below T10 may feel the uterus contracting.
- Feelings of early contractions may come and go away as labor continues.
- There may be changes in breathing or spasticity.

- Although AD is more common for people with a T6 level of injury and above, AD can occur in women with any level of injury during labor.
 - The best way to prevent AD during labor is to use a continuous epidural anesthesia. This provides a long-lasting numbness during labor.

Delivery

There is no need to have a Cesarean section (or C-section) simply because you have an SCI. In fact, most women can deliver vaginally no matter what their level of injury. Talk with your obstetrician about the type of delivery that is best for you if there are concerns.

- In some cases, a doctor may use a vacuum cup or forceps to help deliver the baby.

After Delivery

Congratulations on your new baby! Here are a few new things to think about now.

- **Dizziness.** You may feel faint or dizzy when you sit up after delivery. Sit up slowly, wear elastic hose, or use an abdominal binder.
- **Breast feeding.** You may decide to breastfeed your baby. Most women with SCI can breastfeed, but you need to watch for problem issues.
 - You may notice more bladder spasticity as you breastfeed.
 - You may produce less milk if you have a loss of feeling in your nipples. This is because nipple contact is the trigger for breasts to produce milk.
- **Heat lamps.** Some women have an episiotomy (pronounced eh-pee-zee-ah-toe-me) during delivery to widen the opening of the vagina. Doctors often suggest the use of a heat lamp to help heal the skin near the episiotomy. Women with SCI should **not** use a heat lamp on that area because they won't be able to feel burning.

Authorship

Pregnancy and Women with Spinal Cord Injury was developed by Amie B. McLain, M.D., Taylor Massengill, B.A., and Phil Klebine, M.A., in collaboration with the SCI Model Systems Knowledge Translation Center.

Disclaimer: This information is not meant to replace the advice of a medical professional. You should consult your health care provider regarding specific medical concerns or treatment. The contents of this fact sheet were developed under a grant from the Department of Education, NIDRR grant number H133A110004. However, those contents do not necessarily represent the policy of the Department of Education, and you should not assume endorsement by the Federal Government.

Copyright © 2015 Model Systems Knowledge Translation Center (MSKTC). May be reproduced and distributed freely with appropriate attribution

Respiratory Health and Spinal Cord Injury

August 2015

www.msktc.org/sci/factsheets

SCI Fact Sheet

This fact sheet offers basic information about how the respiratory system changes after spinal cord injury, how those changes may impact health, and how you can better manage your health.

What does the respiratory system do?

Your respiratory system (or pulmonary system) is responsible for breathing. This system enables you to inhale oxygen into your blood and exhale carbon dioxide. Your body needs the oxygen to survive, and carbon dioxide must be removed to avoid the build-up of acid in your body.

How does the respiratory system work?

You normally breathe without thinking about it, but your brain is carefully coordinating this activity. Your brain sends signals down your spinal cord to the phrenic nerves which start at the 3rd, 4th, and 5th cervical spinal levels to contract the diaphragm.

- You can learn more about spinal nerve function in the fact sheet, "Understanding Spinal Cord Injury, Part 1 – The Body Before and After Injury."

Your diaphragm is the dome-shaped muscle located under each lung (at the bottom of your chest) and is the primary muscle used for inhaling. The diaphragm moves down as it contracts.

Your lungs, rib cage and abdomen (belly) expand as air is drawn into (inhaling) your lungs through your nose and mouth. Air travels through the main airway (the trachea) and smaller airways (a series of tubes) that lead to the air sacs. Air sacs in your lungs transfer oxygen from the air to your blood. Your diaphragm moves up to where it started as it relaxes after inhalation. Your lungs, rib cage and abdomen (belly) get smaller as the muscles of inhalation relax, pushing carbon dioxide out (exhaling) through your nose and mouth.

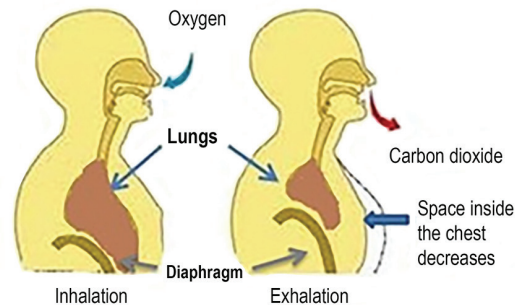

You normally need more muscle strength, or force, to help with breathing when you exercise or cough. To provide this added assistance, particularly to help with exhaling forcefully during a cough, your brain sends signals down your spinal cord and out through the nerves coming from the thoracic portion of the spinal cord to direct your abdominal muscles (over your belly) and intercostal muscles (between the ribs).

- Coughing is important because you produce small amounts of mucus in your lungs every day. Coughing helps to remove the mucus and prevent mucus build-up that can block the airways leading to the air sacs in your lungs that absorb the oxygen from the air. When you cough, the muscles responsible for most of the force are the abdominal muscles.

How does spinal cord injury impact the respiratory system?

Signals sent from your brain can no longer pass beyond the damage to the spinal cord, so your brain can no longer control the muscles that you would normally use for inhaling and exhaling. The extent of your muscle control loss depends on your level of injury and if there is complete or incomplete spinal cord damage.

If you have a complete **high cervical injury** that involves the spinal cord at or above the cervical 3rd, 4th, and 5th spinal nerves, you may have a loss of or weakness in diaphragm function depending on the extent of damage. You may even need a tracheostomy (an opening through the neck into the

The Spinal Cord Injury Model System is sponsored by the National Institute of Disability, Independent Living, and Rehabilitation Research, U.S. Department of Health and Human Services' Administration for Community Living. Opinions expressed in this fact sheet are not necessarily those of the granting agency. (See <http://www.msktc.org/sci/model-system-centers> for more information).



trachea, the main airway to help a person breathe) or ventilator (a machine that helps a person breathe by pushing air into the lungs). With a complete **lower cervical injury** that does not involve the cervical 3rd, 4th, and 5th spinal nerves, diaphragm function remains and usually a ventilator is not needed. In high and low complete cervical injury, you also will have a loss of control of your abdominal muscles (over your belly) and intercostal muscles (between the ribs). In **incomplete cervical injuries**, the degree of diaphragm weakness or loss of other muscle control depends on the extent of damage. If you have a **thoracic level of injury** (see image), you can lose some or all control of your abdominal muscles (over your belly) and intercostal muscles (between the ribs). The amount of loss depends on the location and extent of spinal cord damage. If you have only **lumbar** or **sacral injury levels** then your abdominal and intercostal muscles are not affected.

If you require a ventilator to breathe due to loss of diaphragm function, a pacing system to stimulate the diaphragm may be an option.

How does loss of muscle function affect my health?

If you have a loss of respiratory muscle control, the muscles that are still functioning have to work harder to get oxygen into your blood and to get rid of the carbon dioxide. You may also have trouble coughing with enough force to get rid of mucus in your lungs. This puts you at an increased risk for respiratory health problems.

- Both a higher injury level and whether a person has complete or incomplete injury contribute to the risk of respiratory problems.
- Persons with a higher and more complete injury (for example, complete cervical) are at higher risk for respiratory problems than persons with a lower and incomplete injury.

What health problems are common?

Bronchitis is an infection in the tubes that lead to the air sacs in the lungs, and **pneumonia** is an infection in the air sacs. These infections are very serious health problems because extra mucus is produced. Mucus will build up if the ability to cough is reduced due to muscle weakness or paralysis. The buildup of mucus can result in **atelectasis** ((at-uh-LEK-tuh-sis), which is a collapse of all or a portion of the lung.

Although people with cervical or thoracic injury are at highest risk for having complications, such as atelectasis with these infections, those with the highest risk are those who:

- smoke
- have chronic obstructive pulmonary disease
- have a tracheostomy
- use a ventilator

Obstructive sleep apnea (OSA) is another common problem. OSA occurs when a loss of muscle tone during sleep in the tongue, soft palate or other soft tissues of the throat allows the airway to collapse and obstructs the flow of air when you try to breathe in. This typically causes a drop in blood oxygen level and a rise in blood carbon dioxide level. The brain responds with a brief arousal to “jump-start” breathing. This disruption of sleep repeats throughout the night, but most people are not aware of it, because it does not cause them to fully wake up. Even though it may not wake you up, the sleep disruption can make you sleepy during the day, no matter how long you sleep at night. OSA is also associated with a number of medical problems such as:

- depression
- diabetes
- heart attacks, heart failure, and irregular heartbeat
- high blood pressure
- stroke
- death

Anyone can have OSA, but the risk is greater for people who:

- snore
- are male (the risk of OSA is also higher in post-menopausal than in pre-menopausal women)
- are overweight or obese

- drink alcohol
- take muscle relaxant medication
- have a small jaw, enlarged tonsils, or difficulty breathing through the nose

What can I do for my respiratory health?

Prevention - Your first defense is to do whatever you can to prevent respiratory health problems. Here is a checklist.

- ✓ Do not smoke and stay away from secondhand smoke! Exposure to tobacco smoke is the worst thing you can do for your health. Smoking causes chronic obstructive pulmonary disease (COPD), and lung cancer, and exposure to cigarette smoke diminishes your health in many, many ways. COPD can cause the body to produce extra mucus and also causes a reduction in lung function in addition to the reduction in lung function attributable to the muscle weakness and paralysis that accompanies spinal cord injury. Plus, exposure to smoke can make worse many health problems you develop.
- ✓ Avoid the buildup of secretions in the lungs. If you have difficulty coughing and clearing secretions, a cough assist machine can be helpful in keeping your lungs clear. If you have a tracheostomy with or without a ventilator, you can also use a suction tube to keep your lungs clear. An attendant or family member can also be trained to manually assist with coughing.
- ✓ Stay hydrated. Drink plenty of water, especially if you have an infection, unless your doctor tells you something different.
- ✓ Keep a healthy weight! People who are overweight or obese typically have more problems with their lungs. They also tend to get obstructive sleep apnea. Ask your health care providers to recommend a diet if you are overweight and an exercise program to help maintain fitness. There is evidence from non-SCI populations that maintaining a high level of activity and taking part in rehabilitation programs that typically include both an aerobic and strength training component prevent future health problems. Persons with SCI who take part in an exercise program or in a sport also report a higher quality of life.
- ✓ Stay away from people who may have a cold or flu.
- ✓ Get a flu shot every year. This shot will help keep you from getting the flu but *does not* cause the flu.
- ✓ Get a pneumonia shot. Pneumonia and other pulmonary infections are among the most common causes of death following SCI, but the shot can help keep you from getting a common type of bacterial pneumonia. In persons age 65 or older, revaccination with the same shot you received before 65 is suggested. Furthermore, an additional pneumonia vaccine has been developed for persons age 65 or older that is directed at other types of this common bacteria. You should ask your health care provider about the timing of shots based on current guidelines from the US Centers for Disease Control and Prevention.
- ✓ Watch – Even with your best efforts to prevent respiratory health problems, they can still develop. The sooner you can identify any problems, the better your chance of treating them and getting better.

Signs and symptoms of a lung infection (bronchitis and pneumonia) are not always easy to identify. Mild signs and symptoms might first seem like those of a cold or flu, but they can last longer and get worse over time. Some signs and symptoms of infection may include:

- Fever and chills
- Cough or feeling the need to cough (coughing may produce thick, sticky mucus that might be clear, white, yellowish-gray or green in color, depending on the type of illness)
- Tightness in the chest
- Shortness of breath

Signs and symptoms of obstructive sleep apnea may also be mild at first and get worse over time. In fact, you might wake and fall back asleep many times throughout the night without realizing it. However, you can watch for some common signs that suggest you might have sleep apnea:

- Other people tell you that you stop breathing at night
- Loud snoring
- Restless sleep (especially if you awaken choking or gasping for air)

- Waking up with a sore and/or dry throat
- Waking with a headache
- Daytime fatigue, sleepiness, or not feeling rested after sleeping

Visit your Healthcare Provider – You should see your healthcare provider every year for a check-up to check for the health problems common to someone your age and with your type of injury. Persons with lung disease, such as COPD or asthma may need to see a provider more often.

- ALWAYS go see your provider if you have signs of a respiratory infection. It is important to be aggressive and avoid waiting until a mild problem becomes a much larger health problem.
- ALWAYS go see your provider if you think you have sleep apnea. Sleep apnea is a serious condition. Your provider can set you up to get a sleep study and find a treatment option that works for you.
- Ask your provider if you should get a lung function test to see how well your lungs function. This is especially important if you have ever smoked, have COPD, or have asthma. If you have problems breathing, you may need medication that opens the airways to help the lungs work, helps you breathe easier, and makes it easier to do your day-to-day activities.

Authorship

Respiratory Health and Spinal Cord Injury was developed by Eric Garshick, MD, MOH, Phil Klebine, MA, Daniel J. Gottlieb, MD, MPH, and Anthony Chiodo, MD in collaboration with the Model Systems Knowledge Translation Center. Dr. Garshick and Dr. Gottlieb are members of the Pulmonary, Allergy, Sleep, and Critical Care Medicine Section, VA Boston Healthcare System, Department of Veterans Affairs, Boston, MA.

Source: Our health information content is based on research evidence and/or professional consensus and has been reviewed and approved by an editorial team of experts from the Spinal Cord Injury Model Systems.

Disclaimer: This information is not meant to replace the advice of a medical professional. You should consult your health care provider regarding specific medical concerns or treatment. The contents of this fact sheet were developed under a grant from the National Institute on Disability, Independent Living, and Rehabilitation Research (NIDILRR grant number 90DP0012). The contents of this fact sheet do not necessarily represent the policy of Department of Health and Human Services, and you should not assume endorsement by the Federal Government.

Copyright © 2015 Model Systems Knowledge Translation Center (MSKTC). May be reproduced and distributed freely with appropriate attribution



Sexuality & Sexual Functioning After Spinal Cord Injury

December 2015

www.msktc.org/sci/factsheets

SCI Fact Sheet

It is natural to have questions about relationships, sex, and having children after spinal cord injury. This fact sheet will help you better understand your body and answer some common questions after injury.

What is sexuality?

Your sexuality is what guides your natural desire to bond with others through love, affection, and intimacy. Here are a few ways you might express your sexuality.

- **Emotional connections**—feeling close to someone
- **Physical contact**—acts of touching such as holding hands, hugging, kissing, cuddling, and sexual activity.
- **Sexual identity**—how you think and feel about yourself and your desires for the opposite sex, same sex, or both.
- **Gender identity**—the gender you feel you are “inside” (your body may or may not match the gender you feel you are).

How does spinal cord injury impact sexuality?

Loss of muscle movement, sense of touch, and sexual reflexes often occurs after spinal cord injury (SCI). How this loss effects arousal, orgasm, and fertility depends on your level of injury and whether your injury is complete or incomplete.

- To learn more on the nervous system and about complete and incomplete injuries, please see [“Understanding Spinal Cord Injury: Part 1—The Body Before and After Injury”](http://www.msktc.org/lib/docs/Factsheets/SCI_Understand_Spin_Crd_Inj_Prt1.pdf) at http://www.msktc.org/lib/docs/Factsheets/SCI_Understand_Spin_Crd_Inj_Prt1.pdf.

You may not have a strong desire for sex when first injured, but your desire will likely increase over time as you learn to manage self-care and understand your body after injury. If not, talk to your doctor. It is possible your medications are interfering with sexual desire. Changing medications may help.

SCI may also impact how you think and feel about yourself. Some people may not feel desirable after SCI. However, loss of movement or sensation does not change the fact that you are a desirable sexual being. You are more likely to feel desirable and want to fully express your sexuality if you understand your body and feel comfortable with yourself and your personal identity. This fact sheet will help you.

Is dating different after injury?

Here are a few ways dating is usually the same as before your injury.

- You increase your opportunities to meet people by making yourself available to meet them. This might be online dating or getting out and meeting people.
- You have to ask for a date to know if he or she will go out on a date with you.
- It is just as important after injury as it was before your injury to practice safe sex to prevent pregnancy and contracting sexually transmitted infections/diseases.

Here are a few ways dating may be different.

- You will probably be asked about your injury and how you manage daily activities. Be ready to respond in a way that is comfortable for you.
- You may need to balance your dating schedule with a caregiver’s schedule.
- You may be living with a family member or someone else after your injury. If so, you may need to talk with them about setting up guidelines for bringing a date home, privacy, and personal space.

The contents of this fact sheet are based on research evidence and/or professional consensus and has been reviewed and approved by an editorial team of experts from [the Spinal Cord Injury Model Systems, which is sponsored by the National Institute on Disability, Independent Living, and Rehabilitation Research](http://www.msktc.org/sci/model-system-centers) (See <http://www.msktc.org/sci/model-system-centers> for more information).



Understanding Sexual Arousal

What is sexual arousal?

Sexual arousal is the body's response to your desire for sex. This includes an increase in heart rate, blood pressure, and breathing rate, and can include an increase in blood flow to the genitals to ready your body for sex.

- Women have an increase in vaginal lubrication to ready the vagina for easier, safer penetration.
- Men get an erection.

People without SCI are usually aroused through two pathways.

- **Reflex pathway**—Arousal that occurs in response to sensual touching.
- **Psychogenic pathway**—Arousal that occurs from psychological sexual sensations such as sexual thoughts, sights, smells, or sounds that turn you on sexually.

Sexual arousal after injury

One or both of your pathways for arousal may be blocked.

- Most people with SCI can be aroused by sensual touching. Try stimulating your body in sexual ways to find out if you become aroused. Does masturbation feel good? Does oral sex? You might also enjoy touching in areas like your neck, ears, nipples, and inner thighs.
- Some people with SCI, mainly those with an incomplete injury, may be aroused by psychological sexual sensations.
 - The more sensation you have in the area between your belly button and front pant pocket areas (upper outer thigh), the more likely you are to be aroused in your genitals by sexual thoughts, sights, smells, or sounds.

What can I do if I cannot get aroused after injury?

Talk to your doctor. Changing your medications may help with the problem. Often times, spasticity medications, pain medications, or antidepressants are contributing factors. If not, here are other actions that might help address the problem.

- Women—having your partner perform oral sex may help increase vaginal lubrication enough for penetration. Using a water-based lubricant is another option.
- Men—most men can get an erection with sensual touching after you take a medication like sildenafil, tadalafil or vardenafil. If cannot, talk to your health professional about other options, which might include a constricting ring, vacuum suction device, injection of medications into the penis, or a surgically implanted penile prosthesis.

Understanding Orgasm and SCI

What is orgasm?

An orgasm is a reflex response of the nervous system that feels good and relaxes you.

Orgasm after injury

Most people with SCI can still have orgasms. Here are some important facts to know.

- Stimulation to the genitals is usually a good way to achieve orgasm.
- Sensual touching in the area where your sensation changes (at your injury level) may help to achieve orgasm.
- Achieving an orgasm generally takes longer and may feel “different” than it did before your injury.
- Women—using a vibrator is helpful for achieving an orgasm.
- Men—often have orgasms where the semen goes back into the bladder instead of coming out through the penis (also known as retrograde ejaculation).
- Orgasms are often followed by a decrease in spasticity.

What can I do if I cannot have an orgasm after injury?

Remember, sexual activity can be great fun with or without orgasm, but here are some potential options.

- It is important that you and your partner not give up too soon. Sometimes it just takes time and practice.



- Try masturbating with or without a vibrator.
 - If your injury is at or above T6, you should be careful and watch out for headaches and other signs and symptom of Autonomic Dysreflexia (AD). If that happens, stop activity, check your blood pressure, and ask your doctor to review your medications to see if they can be adjusted. For more information about AD, please read “Autonomic Dysreflexia” (Coming Soon).
- Talk to your doctor about using medical devices.
 - Men—a high amplitude vibrator held against the head of the penis may stimulate ejaculation.
 - Women—a gentle suction device can help increase the ability of the clitoris to respond so you can achieve orgasm.

Understanding Fertility and SCI

What is fertility?

Women become pregnant when sperm, which is in semen, fertilizes an egg.

Can I have children after injury?

Yes! You decide to have children in much the same way as anyone else. You consider the demands and challenges of parenting and how you might manage them. Here are other facts to consider when deciding whether or not you want to have children.

- Men and women of all levels of injury have had children after their injury. You can too if you choose.
- The positive aspects of parenting usually outweigh the difficulties.
- <http://www.lookingglass.org/> and <http://www.disabledparents.net/> are good online resources for people with SCI who are or want to be parents.
- You need to practice safe sex if you want to prevent pregnancy
 - Condoms are considered the best choice for both men and women with SCI.
 - Women—talk to your doctor if you are interested in birth control options other than condoms.
 - Intrauterine devices and diaphragms are generally not ideal if you have problems with sensation and insertion.
 - The pill is not usually recommended because it increases your risk for developing a blood clot (deep vein thrombosis).

Do women have problems getting pregnant after injury?

There is usually a brief pause in your period when you are first injured. You can naturally become pregnant, carry, and deliver a baby once your period returns. Contact your doctor if your period does not return with a few months after injury.

You are at higher risk for common secondary complications of SCI during pregnancy, but you can prevent problems or manage problems if they develop. It is best that you have an obstetrician who understands, or is willing to learn, the facts about pregnancy, labor and delivery for women with SCI.

- For more information on pregnancy, labor and delivery, please read “[Pregnancy and Women with Spinal Cord Injury](http://www.msktc.org/sci/factsheets/Pregnancy)” at <http://www.msktc.org/sci/factsheets/Pregnancy>.

Do men have problems getting their partner pregnant after injury?

Some men with SCI can get their partners pregnant through sexual intercourse, but many men cannot.

- May be unable to ejaculate into the vagina during intercourse.
- Sperm may be unable to swim to fertilize the egg (also known as poor sperm motility).

Urologists who are experienced in SCI can offer treatment options.

- In-Home Insemination—if a high amplitude vibrator can stimulate ejaculation, the semen can be collected in a clean cup. The semen can be drawn from the cup into a syringe. The syringe can be inserted into your partner’s vagina, and the semen is slowly injected.
 - Retrograde ejaculation may be treated with medications.
 - Vibratory stimulation may cause Autonomic Dysreflexia if your injury level is T6 or above.
- Medically assisted procedures—doctors may use methods such as electroejaculation, intrauterine insemination, or in vitro fertilization.

How can I help my partner adjust to changes with my body after injury?

Here are some tips for both you *and* your partner.

- Understand your body. This fact sheet is only a starting point to begin to understand how your body might change after injury. Your body is unique, so your issues are unique, too. It can take time to understand how your body works and manage problem issues.
- Take the time to figure out what each of you finds pleasing and exciting. What you did before your injury may work for you. If not, you and your partner can be creative and open to exploring new ways to find sexual satisfaction.
- Have fun. Using humor and being playful are keys to having a more interesting, enjoyable and mutually pleasurable experience.
- Keep an open mind along with an honest and open line of communication. Below are some helpful suggestions:
 - **Know what you want to communicate.** This involves self-awareness and possibly self-exploration to get a clear sense of what you want or need sexually.
 - **Communicate your needs to each other.** Talking about sex can be difficult, so you will want to communicate in a way that makes both you and your partner feel comfortable. Some couples find it helpful to write down their needs. The goal is to talk about any issues or concerns and work together to solve problems and resolve concerns.
 - **Listen to each other.** Healthy communication requires give and take. Listen and be open to your partner's response, just as you would like your partner to do for you. Listening to your partner can help resolve issues in a way that satisfies both partners. This includes paying attention to body language.
 - **Be flexible.** Couples commonly need time to get comfortable with each other. You will likely experience a few setbacks. For example, there may be issues with bowel, bladder, and spasticity. However, you and your partner should be able to manage issues as you continue to communicate, listen, and remain flexible.

How do I keep the romance alive if my partner is also my caregiver?

Do everything you can to keep the role of the caregiver separate from that of a romantic partner. This will better allow you to enjoy each other when you are feeling romantic. Here are some tips.

- Be as independent as possible. Learn to do as much as you can with your self-care and other daily living activities. This will limit the amount of help you need from a caregiver.
- Have set times when caregiving tasks are needed and set other times, like a date night, when there is romance without caregiving. Keeping these roles separate will help you to avoid confusing and blurring the two roles.
- Hire a personal care attendant (PCA) to take on some caregiving tasks if you can. You may qualify for programs that can help if you cannot pay for one. Some agencies that you might contact are your state's Vocational Rehabilitation Services, your local Independent Living Center, or the Department of Veteran's Affairs if you are a veteran.

Who can I talk to if I have problems or questions?

Most problems have a solution, and professionals who know about sexuality *and* issues of SCI are your best option to find solutions. They can provide you with accurate information, treat you with respect, and ensure confidentiality answering your questions.

- Talk to a doctor or nurse about medical needs.
- An occupational therapist or physical therapist can be helpful in suggesting equipment needs.
- An experienced counselor, psychologist, social worker, or sex therapist can usually help individuals and couples work through relationship problems and identify other helpful resources.

Authorship

Sexuality & Sexual Functioning After Spinal Cord Injury was developed by Marcalee Alexander, M.D., Trisha Hicks, MSW, LSW, M.Ed., Mindy Aisen, M.D., and Phil Klebine, M.A., in collaboration with the SCI Model Systems Knowledge Translation Center.

Disclaimer: This information is not meant to replace the advice of a medical professional. You should consult your health care provider regarding specific medical concerns or treatment. The contents of this fact sheet were developed under a grant from the National Institute on Disability, Independent Living, and Rehabilitation Research (NIDILRR grant number 90DP0012). NIDILRR is a Center within the Administration for Community Living (ACL), Department of Health and Human Services (HHS). The contents of this fact sheet do not necessarily represent the policy of NIDILRR, ACL, HHS, and you should not assume endorsement by the Federal Government.

Copyright © 2015 Model Systems Knowledge Translation Center (MSKTC). May be reproduced and distributed freely with appropriate attribution



Surgical Alternatives for Bladder Management Following SCI

January 2015

www.msktc.org/sci/factsheets

SCI Fact Sheet

This fact sheet tells you about two types of surgery that use your intestine to manage bladder problems caused by your injury. Surgery is used only when other bladder management strategies have not worked.

What you need to know

- Your ability to control urine release may be limited because of injury. You may not be able to stop urine from flowing out of your body, or you may not be able to release urine from your body.
- The inability to control the release of urine is called “urinary incontinence” (pronounced in-KAHN-ten-ens).
- The inability to release urine is called “urinary retention.”
- Surgery can sometimes be used to help manage these problems if nonsurgical bladder management approaches do not work. Surgeries that use a part of your intestines will be discussed.
- All surgery comes with risks of bleeding, serious infection, and other side effects.
- More than one surgery may be needed to manage your bladder function.
- Surgery using the intestine to enlarge the bladder or as a substitute for the bladder is very rarely used in adults with SCI. It is more commonly used in children with spina bifida who have a very damaged bladder or in adults who have their bladders removed because of bladder cancer.
- Because surgery using the intestine is used so rarely in adults with SCI, we do not have enough information to discuss risks, benefits, alternatives, and the specific impact on lifestyle in adults with SCI. Therefore, it is very important that you speak with a surgeon who is very experienced in this type of surgery and a rehab doctor to discuss how surgery may help in your specific case.
- To learn about the problems caused by your injury and the strategies used to help you manage bladder problems (see **MSKTC factsheet entitled Bladder Management Options Following Spinal Cord Injury** <http://www.msktc.org/sci/factsheets/bladderhealth>)

Understanding your urinary tract

Waste from your body is removed from your blood stream by your kidneys and becomes urine. Normally, urine passes down the ureters into your bladder (a small pouch that holds your urine located in the lower middle part of your abdomen below your beltline). A sphincter (pronounced SFINK-ter) made of muscle circles the opening of your bladder, where urine flows out of your bladder. The sphincter acts like a valve that opens and closes to control when the urine comes out of your body. When you urinate, your bladder squeezes and your sphincter relaxes. Urine passes from the bladder through the urethra (pronounced yur-EETH-rah) and out of your body. In women, the urethral opening is right above the vagina. In men, the urethral opening is at the tip of the penis. Surgery may involve any of these parts of your urinary tract as well as your intestines or your stomach.

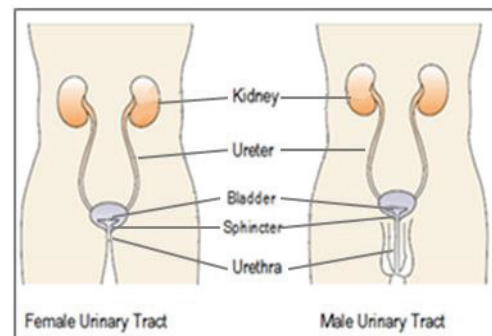

The Spinal Cord Injury Model System is sponsored by the National Institute of Disability, Independent Living, and Rehabilitation Research, U.S. Department of Health and Human Services' Administration for Community Living. Opinions expressed in this fact sheet are not necessarily those of the granting agency. (See <http://www.msktc.org/sci/model-system-centers> for more information).

Why do I need surgery that uses part of my intestine?

Sometimes, your injury or other health issues may limit your ability to use traditional bladder management methods, or the traditional methods are not working as well as they should. The goal of surgery, like other bladder management strategies, is to enable you to remove urine from your body and keep your kidneys healthy and maintain a life style that is best for you. Some of the reasons you might need surgery are:

- You would like to perform intermittent catheterization but this is not practical because you have a very small overactive bladder (a bladder that squeezes with only a small amount of urine in the bladder) despite medications.
- Your bladder has lost its ability to stretch and therefore develops a high pressure when it fills up with urine, causing back pressure and damage to your kidneys despite medications.
- You have a problem that cannot be treated with medications, such as an over-stretched or damaged urethra, which is causing constant urinary leakage.

Will surgery cure my bladder problems?

Surgery cannot make your bladder work normally, but it can:

- Help you be able to use a bladder management strategy such as intermittent catheterization.
- Create new ways for you to release urine from your body.

What are some surgical procedures that use part of my intestine?

There are a number of surgical procedures and variations involving the use of your intestine to help with your bladder problems. The type of surgical procedure that may help you depends on the problem you are having with your bladder and what type of bladder management you would like to have. Below are two common types of surgical procedures.

Bladder Augmentation Surgery

Bladder augmentation (pronounced awg-men-TAY-shun) surgery is for people who are having kidney damage because they have a small bladder with forceful squeezing that causes back pressure to the kidneys. It is also helpful for people who want to perform intermittent catheterization but have a small, overactive bladder despite medications. You should not have this surgery if you are unable or unwilling to perform intermittent catheterization or if you have problems with your bowels such as inflammatory bowel disease. The surgery increases your bladder size so that it has less forceful squeezes (more relaxed), enabling it to hold more urine at one time. It does not improve the way your bladder functions. Having a larger, more relaxed bladder makes it easier for urine to drain from your kidneys into your bladder and more practical to perform intermittent catheterization (for a description of intermittent catheterization, see MSKTC factsheet entitled **Bladder Management Options Following Spinal Cord Injury** <http://www.msktc.org/sci/factsheets/bladderhealth>).

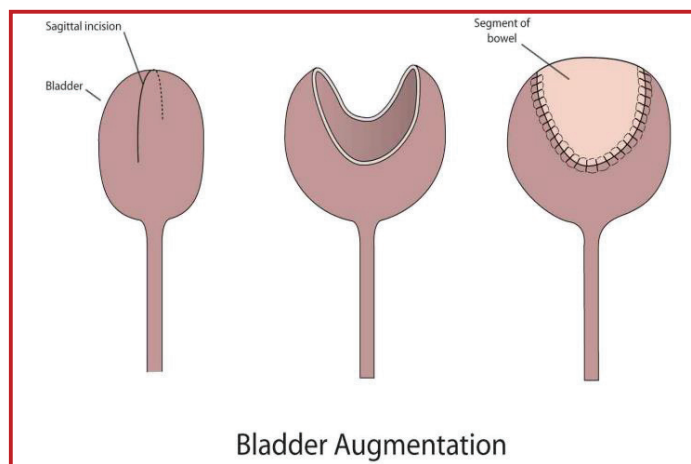

During the surgery:

A surgeon removes a small part of your intestine and then sews the piece onto your bladder, much like sewing the top of a clamshell (intestine) onto the bottom of a clamshell (bladder) to make the bladder larger. If you have a weak sphincter, you may start to leak urine from your urethra. In this case you may need treatment of your sphincter to make it stronger. You and your doctor may consider additional surgical treatment to tighten your sphincter or use a urinary diversion as discussed below.

Urinary Diversion

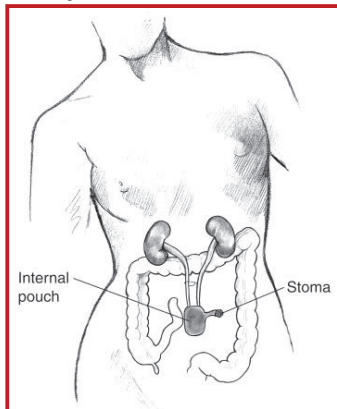

Urinary diversion redirects the urine flow from your bladder to a pouch of intestine that has been made to hold your urine. This surgery is for people who have a very small, damaged bladder that cannot be improved with a bladder augmentation; a bladder that has to be removed for some reason such as cancer; or a very damaged urethra that makes it difficult to pass a catheter into your bladder. In this surgery:

- A surgeon creates an artificial bladder using parts of your stomach or intestine.
- The surgeon then sews your ureters into the new pouch.
- Another piece of intestine is used to make a tube from the pouch to an opening on your abdomen (this opening is called a “stoma” (pronounced STOH-mah).
- Sometimes the pouch can be sewn directly onto your urethra, so you can drain your bladder through your urethra rather than a bag or catheter.

There are two other types of surgery:

Incontinent Urinary Diversion

This form of urinary diversion is called “incontinent” because there is nothing holding the urine in the new bladder. Urine drains out of the opening in your abdomen (stoma) as soon as it is made. A bag outside of your body is attached to the stoma to collect this urine. You can empty the bag whenever it is full.

Continent Urinary Diversion

This form of urinary diversion is called “continent” because the stoma is made with a small fold that keeps the urine from draining out on its own. The urine is held in the new bladder and removed by passing a catheter down through the stoma into the new bladder.

What are the risks of surgery?

All surgery comes with risks. “Risk” means that these problems **could** happen; it does not mean that they **will** happen. Talk with your surgeon or doctor about your overall health and what may be a higher risk for you. There are two types of risks, short-term risks that occur right after surgery and long-term risks (late complications) that can occur later on. Long-term complications take time to develop and may occur several weeks, months, or even years after your surgery.

Some of the more common possible short-term surgical risks include:

- You could have an allergic reaction to or other problems with the anesthesia (pronounced an-es-THEE-zha), the medicine used to put you to sleep during surgery.
- You could develop pneumonia after surgery.
- The wound where the surgery is performed could become infected.
- Your intestines could take a long time to “wake up” after surgery, causing discomfort, vomiting, and constipation.
- You could develop a deep venous thrombosis or pulmonary embolism.
- You could have a urine leak or blockage or other problem from the intestine where you had your surgery, which could require another operation

Some of the more common possible late risks/complications from bladder augmentation or urinary diversion surgery include:

- Increased risk of kidney or bladder stones.
- A tear/rupture of your new intestine pouch due to over-stretching (rare).
- Loose stools or diarrhea, depending on the part and amount of your intestine that is removed.
- Increased risk of cancer at the area around the bladder and intestine (rare).
- Bowel obstruction (blockage) caused by part of your intestine getting caught in some of the scar tissue from your surgery. This is often a surgical emergency requiring surgery to correct the blockage to prevent your intestine from rupturing and causing you to become extremely sick.
- Mucus in the urine because the piece of intestine attached to the bladder may create a lot of mucus. Sometimes this can clog the catheter you are using to drain your bladder or make it difficult to know for sure if you might have a bladder infection.
- There are also specific metabolic changes and other possible complications, depending on which part of your intestine (or your stomach) is used. Your surgeon will be able to tell you more about these possible risks.

Some of the more common possible late complications from urinary diversions (only) include:

- Scar tissue around the tube from the kidney, which squeezes the tube partially shut.
- Narrowing of the skin around the stoma can make it difficult for urine to drain out of the intestinal pouch or pass a catheter down into the intestine pouch to drain the urine.
- Parastomal hernia. The piece of intestine that goes from the pouch up to the skin starts to push up and around the opening of the skin (stoma).

For more details on bladder management including surgical management see: Bladder management for adults with spinal cord injury: a clinical practice guideline for health-care providers. Consortium for Spinal Cord Medicine. J Spinal Cord Med. 2006;29(5):527-73.

Ask your doctor about your level of risk for any of these complications, and what can be done if any of them occur.

Authorship

Surgical Alternatives for Bladder Management After SCI was developed by Todd A. Linsenmeyer, M.D., and Steven Kirshblum, M.D., in collaboration with the Model Systems Knowledge Translation Center.

Source: Our health information content is based on research evidence and/or professional consensus and has been reviewed and approved by an editorial team of experts from the Spinal Cord Injury Model Systems.

Disclaimer: This information is not meant to replace the advice of a medical professional. You should consult your health care provider regarding specific medical concerns or treatment. The contents of this fact sheet were developed under a grant from the National Institute on Disability, Independent Living, and Rehabilitation Research (NIDILRR grant number 90DP0012). The contents of this fact sheet do not necessarily represent the policy of Department of Health and Human Services, and you should not assume endorsement by the Federal Government.

Copyright © 2015 Model Systems Knowledge Translation Center (MSKTC). May be reproduced and distributed freely with appropriate attribution. Prior permission must be obtained for inclusion in fee-based materials.



Surgical and Reconstructive Treatment of Pressure Injuries

January 2020

www.msktc.org/sci/factsheets

SCI Factsheet

This fact sheet offers a basic understanding about surgical and reconstructive treatment of pressure injuries. This information is not meant to replace the advice of a medical professional. You should consult your health care provider regarding specific medical concerns or treatment.

The Spinal Cord Injury Model System is sponsored by the National Institute of Disability, Independent Living, and Rehabilitation Research, U.S. Department of Health and Human Services' Administration for Community Living. (See <http://www.msktc.org/sci/model-system-centers> for more information).

What is a pressure injury?

Pressure injury is a newer term for what people might know as a pressure sore, pressure ulcer, decubitus ulcer, bedsore or skin breakdown. The term changed because not all stages of injuries caused by pressure are actually open "sores" or "ulcers." However, the meaning is similar. A pressure injury is an area of the skin or underlying tissue (muscle, bone) that is damaged when prolonged pressure cuts off blood flow to the area for too long.

- To learn more about skin care, visit <https://msktc.org/sci/factsheets/skincare>.

What Is Surgical and Reconstructive Treatment?

Stage 3 and 4 pressure injuries are wounds that most often need surgical and reconstructive treatment to promote healing.

- Stage 3 is a wound that extends from the first layer of the skin (epidermis), through the second layer (dermis), and into the fatty tissue below (subcutaneous tissue).
- Stage 4 is a wound that extends past the fatty tissue and into the muscle tissue. It can also extend to the bone.

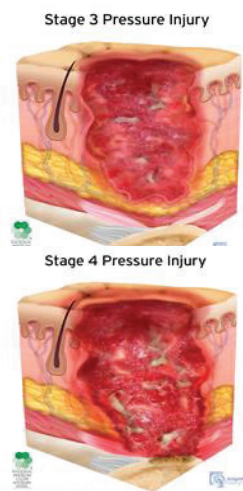

Surgical Treatment

During surgery, the wound is cleaned (debrided) to remove any dead or infected tissue, which sometimes includes removing some bone. This process creates a larger wound, but the remaining tissue is healthy and more likely to heal.

Reconstructive Treatment

Reconstructive treatment is most often done in one of two ways using a section of healthy skin and tissue known as a "flap."

1. A flap of healthy skin and tissue near the wound is partly detached and pulled over the wound. This allows part of the flap to stay attached to the blood vessels connected to healthy skin and tissue. That blood supply helps nourish the skin and tissue pulled over the wound.



2. A flap of healthy skin and tissue is completely detached (sometimes called harvested) from the back, buttocks, or thigh and moved to cover the wound.
 - There are rare times when amputating a leg may need to be considered if a lot of skin and tissue needs to be taken from the leg to cover a large wound elsewhere on the body.

Where on the Body Is the Treatment Usually Needed?

- Ischium (pronounced ish·e·um) – This is the bony area above the back side of the thigh and beneath the buttocks. A pressure injury can develop here when you sit too long without shifting your weight.
- Sacrum (pronounced sac·rum) – This is the bone in the center of your lower back just above your buttocks. A pressure injury can develop here when you lie on your back too long without turning or stay in a reclined position too long without sitting up.
- Trochanter (pronounced tro·can·ter) – This is the boney area on the side of your hip. A pressure injury can develop here when you lie on your side too long without turning.

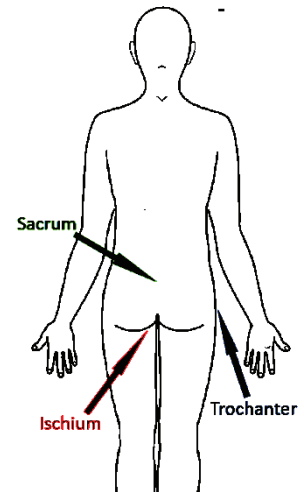

What Are the Benefits of This Treatment?

It can take several months of bedrest for a severe wound to heal on its own. All pressure must be off the area while in bed, which can be very hard to do on an ongoing basis. If pressure is put on the area while in bed, it can delay healing or make the wound worse. Plus, there is an increased risk of infection with any open wound. The longer the wound is open, the longer the higher risk continues. If an infection develops, there is a risk that it can spread and become life-threatening.

The obvious benefit of this treatment is that the wound can heal much quicker than it would without the treatment. Your doctor can explain all your benefits, but here are a few of the benefits:

- Much less time needed for bedrest
- Lowered risk for infection
- Improved quality of life
- Increased independence to enjoy meaningful activities
- Lowered healthcare costs

What Are the Risks of this Treatment?

Problems can happen during any surgery, even with the best treatment. Your surgeon will talk with you to explain what problems might happen. It is up to you to decide whether the benefits of the surgery outweigh the possible risk for problems. Here are a few examples of the more potential serious problems you will talk about with your doctor:

- The wound comes back
- The wound either does not close properly or breaks open along the row of stitches holding the flap edges together

- Harmful bacteria get into the body through an opening in the skin and leads to an infection
- The skin and tissue used for the flap dies
- Bleeding occurs under the flap that may need emergency treatment to drain

Am I a Good Candidate for This Treatment?

Each person is different, and each injury is different. So talk to your medical team to find out if this treatment is a good option for you. In general, it is important to talk about some of the key factors that can give you the best chance for wound healing after surgery. Here are a few of the factors you will talk about with your doctor:

- Your support system – you are responsible for your own health, but your best chance for success is if you have good support from people who are close to you.
- Proper equipment – using proper equipment is critical to promote healing after treatment, effective long-term care, and prevention of potential setbacks.
- Healthy diet – water, folic acid, iron, zinc, and Vitamins B6, B12, and C are a few key parts of a healthy diet that are helpful in skin care and wound healing. It is best to talk with a dietitian to work out a diet that suits your personal needs and tastes.
- Managing health conditions – a primary care doctor or specialist is needed to manage medical concerns like blood pressure, diabetes, incontinence, and other conditions you have.
- Tobacco and nicotine products – skin is damaged and wound healing is hindered by products like cigarettes, cigars, smokeless tobacco, or any electronic nicotine delivery system like e-cigarettes and e-vaporizers.
- Alcohol or drug use – use damages skin and hinders wound healing.

What Can I Do to Give My Wound the Best Chance to Heal?

You should *always* follow the advice of your medical team to have the best outcomes. It is also important to prepare as best as you can for what is ahead.

Preparing yourself

You have to prepare yourself mentally to be ready for recovery. It can take weeks to recover from surgical and reconstructive treatment. This means prolonged bedrest and time to rebuild strength and stamina once you begin the transition from bedrest to sitting up again. It also means your social life will be limited during that time.

- It is human nature to rush through recovery, but you can help prevent setbacks by being patient with the healing process. It might be helpful to think of recovery as a short-term sacrifice for a long-term gain.
- You can plan ahead to find ways that you can fill your time and engage your mind. You might play video games, enjoy a book (hard-copy or audio book), listen to music or podcasts, or binge watch movies and TV.
- You may also need to make some personal changes to give yourself the chances for recovery. For example, you may need to change your diet, manage health conditions, and *stop* using any tobacco and nicotine product.
 - Tobacco and nicotine products are especially bad because using them narrows the blood vessels to your skin. This means that your skin cannot get as much oxygen and nutrients because of impaired blood flow, so the wound and the flap will not heal properly.

Preparing for Surgery

You and your surgeon will discuss ways to help avoid problems that can happen during the surgery. Here are some common topics you will likely discuss before surgery:

- A wound care history is needed to know how long the wound has been present, if there are other wounds, and what treatments have been done already.
- A health evaluation is needed to get blood work, x-rays, and a review of your diet and current secondary medical conditions.
- Muscle spasms (spasticity) are a common after SCI. They must be well controlled to keep spasm movements from damaging the flap.
- Any current infection is treated.
- A medical test may be done to check for a urinary tract infection.
- Redness at the wound edge, a foul odor, and pus are signs of an infection.

Preparing to Go Home After Surgery

Your discharge recovery plan will be made before surgery. Your care plan will focus on doing everything possible to promote healing and prevent problems.

- You will need to be taught wound care, or your family will need to be taught if they are going to help manage your care. Normally, not much wound care is needed other than cleaning, keeping the area dry, and managing any wound drains.
- Home health care or a stay in a skilled nursing facility may be set up if needed.
- Follow-ups with your doctor as needed.
- You must have the proper equipment to promote healing and help prevent future skin problems.
 - A pressure-reducing mattress (such as a low air loss mattress or an air fluidized bed). You will lie on this air or fluid bed to reduce pressure on the healing wound.
 - A pressure-reducing seat cushion. Pressure mapping should be done for wheelchair users to ensure that the best cushion is used. Pressure mapping uses a thin, sensor mat on the wheelchair seat. A computer screen displays how well your weight is spread across the seat surface. Spreading weight out help reduce pressure points that are more likely to damage the skin.
- Continue to do regular pressure reliefs (sometimes called weight shifting, pressure redistribution, and pressure reduction) exactly as recommended by your treatment team. You need to take great care when doing pressure reliefs to avoid bumping, shearing, and other stresses to the wound.
- It is vital that you give the area time to heal before putting pressure back on it. You can easily re-injure the area if you put pressure on it too soon.
 - Sitting protocol – You will slowly begin the transition from bed rest to sitting in your wheelchair once the wound has had time to heal. It's common to sit for short lengths of time, maybe 15 minutes, for only a few times per day at first. The time you spend sitting will gradually increase as the wound continues to heal.

- Harmful bacteria get into the body through an opening in the skin and leads to an infection
- The skin and tissue used for the flap dies
- Bleeding occurs under the flap that may need emergency treatment to drain

Am I a Good Candidate for This Treatment?

Each person is different, and each injury is different. So talk to your medical team to find out if this treatment is a good option for you. In general, it is important to talk about some of the key factors that can give you the best chance for wound healing after surgery. Here are a few of the factors you will talk about with your doctor:

- Your support system – you are responsible for your own health, but your best chance for success is if you have good support from people who are close to you.
- Proper equipment – using proper equipment is critical to promote healing after treatment, effective long-term care, and prevention of potential setbacks.
- Healthy diet – water, folic acid, iron, zinc, and Vitamins B6, B12, and C are a few key parts of a healthy diet that are helpful in skin care and wound healing. It is best to talk with a dietitian to work out a diet that suits your personal needs and tastes.
- Managing health conditions – a primary care doctor or specialist is needed to manage medical concerns like blood pressure, diabetes, incontinence, and other conditions you have.
- Tobacco and nicotine products – skin is damaged and wound healing is hindered by products like cigarettes, cigars, smokeless tobacco, or any electronic nicotine delivery system like e-cigarettes and e-vaporizers.
- Alcohol or drug use – use damages skin and hinders wound healing.

What Can I Do to Give My Wound the Best Chance to Heal?

You should *always* follow the advice of your medical team to have the best outcomes. It is also important to prepare as best as you can for what is ahead.

Preparing yourself

You have to prepare yourself mentally to be ready for recovery. It can take weeks to recover from surgical and reconstructive treatment. This means prolonged bedrest and time to rebuild strength and stamina once you begin the transition from bedrest to sitting up again. It also means your social life will be limited during that time.

- It is human nature to rush through recovery, but you can help prevent setbacks by being patient with the healing process. It might be helpful to think of recovery as a short-term sacrifice for a long-term gain.
- You can plan ahead to find ways that you can fill your time and engage your mind. You might play video games, enjoy a book (hard-copy or audio book), listen to music or podcasts, or binge watch movies and TV.
- You may also need to make some personal changes to give yourself the chances for recovery. For example, you may need to change your diet, manage health conditions, and *stop* using any tobacco and nicotine product.
 - Tobacco and nicotine products are especially bad because using them narrows the blood vessels to your skin. This means that your skin cannot get as much oxygen and nutrients because of impaired blood flow, so the wound and the flap will not heal properly.

Preparing for Surgery

You and your surgeon will discuss ways to help avoid problems that can happen during the surgery. Here are some common topics you will likely discuss before surgery:

- A wound care history is needed to know how long the wound has been present, if there are other wounds, and what treatments have been done already.
- A health evaluation is needed to get blood work, x-rays, and a review of your diet and current secondary medical conditions.
- Muscle spasms (spasticity) are a common after SCI. They must be well controlled to keep spasm movements from damaging the flap.
- Any current infection is treated.
- A medical test may be done to check for a urinary tract infection.
- Redness at the wound edge, a foul odor, and pus are signs of an infection.

Preparing to Go Home After Surgery

Your discharge recovery plan will be made before surgery. Your care plan will focus on doing everything possible to promote healing and prevent problems.

- You will need to be taught wound care, or your family will need to be taught if they are going to help manage your care. Normally, not much wound care is needed other than cleaning, keeping the area dry, and managing any wound drains.
- Home health care or a stay in a skilled nursing facility may be set up if needed.
- Follow-ups with your doctor as needed.
- You must have the proper equipment to promote healing and help prevent future skin problems.
 - A pressure-reducing mattress (such as a low air loss mattress or an air fluidized bed). You will lie on this air or fluid bed to reduce pressure on the healing wound.
 - A pressure-reducing seat cushion. Pressure mapping should be done for wheelchair users to ensure that the best cushion is used. Pressure mapping uses a thin, sensor mat on the wheelchair seat. A computer screen displays how well your weight is spread across the seat surface. Spreading weight out help reduce pressure points that are more likely to damage the skin.
- Continue to do regular pressure reliefs (sometimes called weight shifting, pressure redistribution, and pressure reduction) exactly as recommended by your treatment team. You need to take great care when doing pressure reliefs to avoid bumping, shearing, and other stresses to the wound.
- It is vital that you give the area time to heal before putting pressure back on it. You can easily re-injure the area if you put pressure on it too soon.
 - Sitting protocol – You will slowly begin the transition from bed rest to sitting in your wheelchair once the wound has had time to heal. It's common to sit for short lengths of time, maybe 15 minutes, for only a few times per day at first. The time you spend sitting will gradually increase as the wound continues to heal.

What If I Have More Than One Pressure Injury?

You and your surgeon will decide whether more than one surgery is needed if you have more than one severe wound.

What Do I Do If I Have Questions?

- Ask your doctor to explain anything you do not understand.
 - This treatment cannot restore normal sensation in areas that have lost sensation because of the SCI.
 - Ask for information that explains in detail all the possible risks and benefits of the treatment.
- You can learn more by reading the factsheet, “Skin Care and Pressure Sores in Spinal Cord Injury” at <https://msktc.org/sci/factsheets/skincare>.

References

Terminology on pressure injuries and stages of pressure injuries is based on education and clinical resources provided by the National Pressure Ulcer Advisory Panel (<http://www.npuap.org>). The panel serves as the authoritative voice for improved patient outcomes in pressure injury prevention and treatment through public policy, education, and research.

Authorship

Surgical and Reconstructive Treatment of Pressure Injuries was developed by Jorge de la Torre, M.D., F.A.C.S., M.S.H.A.; Cheryl Lane, DNP, ANP & FNP, CWCN, CRRN; and Phil Klebine, M.A in collaboration with the Model Systems Knowledge Translation Center.

Source: The content in this factsheet is based on research evidence and/or professional consensus and has been reviewed and approved by an editorial team of experts from the Spinal Cord Injury Model Systems (SCIMS), funded by the National Institute on Disability, Independent Living, and Rehabilitation Research (NIDILRR).

Disclaimer: This information is not meant to replace the advice of a medical professional. You should consult your health care provider regarding specific medical concerns or treatment. The contents of this factsheet were developed under a grant from the National Institute on Disability, Independent Living, and Rehabilitation Research (NIDILRR grant number 90DP0082). NIDILRR is a Center within the Administration for Community Living (ACL), Department of Health and Human Services (HHS). The contents of this factsheet do not necessarily represent the policy of NIDILRR, ACL, HHS, and you should not assume endorsement by the Federal Government.

Copyright © 2020 Model Systems Knowledge Translation Center (MSKTC). May be reproduced and distributed freely with appropriate attribution. Prior permission must be obtained for inclusion in fee-based materials.



Understanding Spinal Cord Injury: Part 1— The Body Before and After Injury

May 2022

<https://msktc.org/sci/factsheets>

SCI Factsheet

This factsheet is intended to be a starting point for understanding the normal functions of the spinal cord and how those functions might change after spinal cord injury (SCI). The impact of injury is different for everyone, so it is impossible to answer every question of interest. However, this factsheet will answer a few common questions.

*The end of the spinal cord is the conus medullaris. Below the conus medullaris, the spinal nerve roots look like a horse's tail, which is why these nerves are called the cauda equina, the Latin term for "horse's tail."

The Spinal Cord Injury Model System Program is sponsored by the National Institute on Disability, Independent Living, and Rehabilitation Research, Administration for Community Living, U.S. Department of Health and Human Services. (See <https://msktc.org/sci/model-system-centers> for more information).

What is the spine?

The spine (also known as the "backbone") is the connected column of bones running from your head to your lower back. A single bone is called a "vertebra" (pronounced VER-teh-rah), and multiple bones are called "vertebrae" (pronounced VER-teh-bray). The figure shows the spine and vertebrae.

The figure also shows the five sections of the spine. Each section is made up of a group of vertebrae.

- At the top of the spine, at your neck, is the cervical (C) section. There are 7 vertebrae in this section. Each vertebra is numbered top to bottom from C1 to C7.
- Below the cervical section is the thoracic (T) section. There are 12 vertebrae here. Each is numbered from T1 to T12.
- The lumbar (L) section follows. There are 5 vertebrae here. Each is numbered from L1 to L5.
- The next section is the Sacral (S) section. This is also called the "sacrum." Here the 5 vertebrae are fused together as one bone.
- At the bottom of the spine, 3 to 5 vertebrae are fused together as one bone segment in the coccygeal (Cx) section. This is also called the "tailbone."

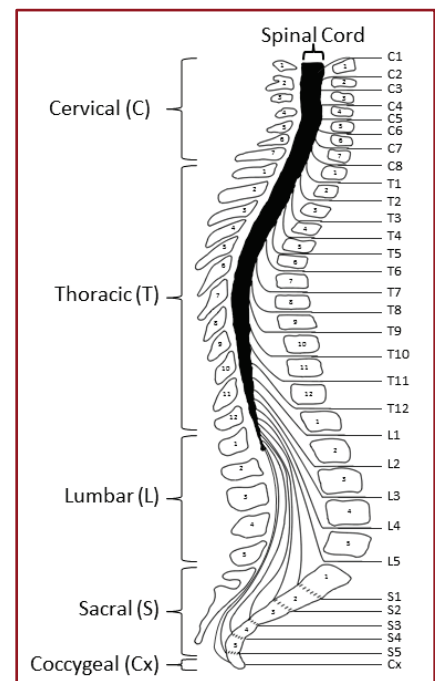

What is the spinal cord?

The spine surrounds and protects the spinal cord, which is a fragile, dense bundle of nerves running from the base of your brain down through the open space in the vertebrae (also known as the spinal canal). The spinal cord ends near the L1 vertebra, but spinal nerve "roots" continue to run from the end of the spinal cord to the lower spinal canal.*

What does the spinal cord do?

Your brain and spinal cord are part of your body's nervous system. The brain is the command center for your body. The spinal cord is the nerve pathway that allows your brain and body to communicate.



Spinal nerves are another part of this message system. There are 31 pairs of spinal nerves branching from the left and right sides of the spinal cord. These nerve pairs are numbered to match the number of the vertebra nearest to where they leave the spine. For example, the T2 spinal nerves exit the spinal column below the T2 vertebra. When all the nerve pairs exit the spinal column, they begin to branch off into the many nerves that spread like a spider web to all parts of your body. Your medical condition is stable such that you can take part in at least 3 hours of therapy, 5 days per week (or 15 hours of therapy over 7 days).



When your nervous system is working properly, it carries vital messages to and from your brain and body. The nervous system is a complex process, but the flow of messages basically control three important functions:

1. *Motor function* is your ability to control the movement of your muscles.
2. *Sensory function* is the sensation of touch, your ability to “feel” things.
3. *Autonomic function* refers to the reflex actions that your brain controls without you having to think about it. Your blood pressure is one example.

What is a spinal cord injury?

A spinal cord injury (SCI) is damage to the spinal cord or the spinal nerve roots within the spinal canal and resulting in temporary or permanent loss of movement and/or feeling.

What are common causes of spinal cord injury?

According to the National SCI Statistical Center, motor vehicle crashes are the most common cause of SCI. Accidental falls are the next most common cause of SCI, followed by acts of violence (mostly gunshot wounds).



What is “level of injury?”

This refers to your neurological level of injury. It is the lowest point on your body where you have normal movement and feeling after SCI. Medical professionals find this point using the International Standards for Neurological Classification of SCI. The exam has two parts.

- Muscle strength tests are used to find the lowest point on your body where you have normal movement.
- “Pin-prick” and “light-touch” skin tests are used to find the lowest point on your body where you have normal feeling.

What is the difference between “complete” and “incomplete” injury?

When medical professionals find your level of injury, they also use the ASIA Impairment Scale (AIS) to grade the severity of your injury. The difference between complete and incomplete is whether or not you have any feeling in your anal area or you can tighten your anus.

- Complete injury—You do not have feeling in your anal area and cannot tighten your anus. This is graded as AIS A. Although your injury level is the lowest point where you have “normal” movement and feeling, you may or may not still have some feeling or movement below your injury level. It may extend one level or as much as a few levels below your injury level. This is your Zone of Partial Preservation.
- Incomplete injury—You have feeling in your anal area or can tighten your anus. Your grade depends on how much feeling or movement you have below your injury level. AIS B means you have feeling but not muscle movement below your injury level. AIS C means you have weak muscle movement below your injury level. AIS D means you have strong muscle movement below your injury level.



Why do I need to know the difference between complete and incomplete?

There is no sure way to tell if function will return after injury, but your potential for recovery is based on whether the severity of your injury is complete or incomplete [see "Understanding of Spinal Cord Injury: Part 2—Recovery and Rehabilitation"].

What is paralysis?

"Paralysis" is a word used to describe a loss in the ability to control muscle movement, but it often includes the loss of other functions, too. The degree of paralysis is greater for higher levels of injury compared to lower levels of injury. Examples:

- A person with a complete C4 level of injury is paralyzed from the shoulders down.
- A person with a complete T12 level of injury is paralyzed from the waist down.

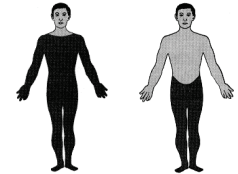

What is tetraplegia?

"Tetraplegia" (pronounced tet-ra-plē-jah), also known as "Quadriplegia" (pronounced kwä-drē-plē-jah) is paralysis caused by a cervical injury. It includes some degree of paralysis in both the upper body (shoulders, arms, hands, and fingers) and lower body (chest, legs, feet, and toes).

What is paraplegia?

"Paraplegia" (pronounced para-plē-jah) describes paralysis that results from a thoracic, lumbar, or sacral injury. It includes some degree of paralysis in the lower body (chest, legs, feet, and toes).



More in the "Understanding Spinal Cord Injury" series: Part 2—Recovery and Rehabilitation

Authorship

"*Understanding Spinal Cord Injury: Part 1—The Body Before and After Injury*" was developed and updated by Phil Klebine, M.A., in collaboration with the Model Systems Knowledge Translation Center.

Source: The content in this factsheet is based on research and/or professional consensus. This content has been reviewed and approved by experts from the Spinal Cord Injury Model Systems (SCIMS) centers, funded by the National Institute on Disability, Independent Living, and Rehabilitation Research (NIDILRR).

Disclaimer: This information is not meant to replace the advice of a medical professional. You should consult your health care provider about specific medical concerns or treatment. The contents of this factsheet were developed under a grant (number H133A110004) from the U.S. Department of Education (ED), National Institute on Disability and Rehabilitation Research (NIDRR). It was updated under a grant (number 90DPKT0009) from the National Institute on Disability, Independent Living, and Rehabilitation Research (NIDILRR). NIDILRR is a Center within the Administration for Community Living (ACL), Department of Health and Human Services (HHS). The contents of this factsheet do not necessarily represent the policy of NIDILRR, ACL, HHS, or ED and you should not assume endorsement by the federal government.

Recommended Citation: Klebine, P. (2022). *Understanding spinal cord injury: Part 1—The body before and after injury*. Model Systems Knowledge Translation Center (MSKTC). https://msktc.org/sci/factsheets/Understanding_SCI_Part_1

Copyright © 2022 Model Systems Knowledge Translation Center (MSKTC). May be reproduced and distributed freely with appropriate attribution. Prior permission must be obtained for inclusion in fee-based materials.



Understanding Spinal Cord Injury, Part 2—Recovery and Rehabilitation

January 2020

www.msctc.org/sci/factsheets

SCI Factsheet

This fact sheet is the second in a two-part series in understanding spinal cord injury and answers some of the common questions people have during the early period after injury. Part one, *The Body Before and After Injury*, explains terms and information that are discussed in this fact sheet, including severity, level of injury, and changes in function.

The Spinal Cord Injury Model System Program is sponsored by the National Institute on Disability, Independent Living, and Rehabilitation Research, Administration for Community Living, U.S. Department of Health and Human Services. (See <http://www.msctc.org/sci/model-system-centers> for more information).

Can paralysis caused by spinal cord injury be reversed?

Everyone wants to know if there is a “cure” for spinal cord injury (SCI). There continues to be significant progress made toward this goal, but, despite any claim that there is a cure, there is currently no cure or proven way to completely reverse paralysis caused by SCI.

Will I gain any improvements?

There is almost always hope for at least some improvement after SCI. Here are the three areas for potential improvement after SCI.

1. The severity of your injury may improve. At the time of your injury, your injury is graded as either complete or incomplete. One example of improvement is that you may be first classified as AIS C and improve to AIS D.
2. The level of your injury may improve. At the time of your injury, you are diagnosed with a neurological level of injury. One example of improvement is that you may be first classified with a C4 level of injury and improve to a C5 level.
3. Your functional abilities may improve. These are the activities that you are capable of doing with the movement that you have. This also includes what you can do with the help of home modifications, medical equipment, adaptive devices, assistive devices, and assistive technologies. One example of improvement is that you may not first have the strength or movement needed to push a wheelchair but gain the needed strength and movement over time.

How much improvement will I gain?

There is no guarantee and no way to know how much, or if any, improvements you will have. You have to wait to see what happens in the months after your injury. However, here are a few basic rules of thumb on improvement.

- Many people with complete injuries regain 1 to 2 levels of injury. The improved muscle movement can result in improved functional abilities.
- People with incomplete injuries are more likely than people with complete injuries to regain muscle movement.
- Your chances for regaining muscle movement are better as long as you are seeing gains in muscle movement or feeling.
- Your chances for regaining control of muscle movement get lower the longer you go without seeing any gains in muscle movement or feeling.



What is Rehabilitation?

The way your brain and body work together changes after SCI. You may lose your ability to control muscle movement and your ability to “feel” things. Your brain may no longer be able to guide your ability to control your bowel, bladder, and other body functions. Simply put, you probably cannot do some daily living activities in the same way as you did before your injury.

Rehabilitation (rehab) is a medical specialty that helps you find different ways to do the daily living activities. Rehab offers skilled professionals who work as a team to help you achieve the best possible health, functional abilities, and quality of life after SCI.

Key Members of Your Rehab Team

- Physiatrists (pronounced fiz-EYE-ah-trists) are rehab doctors who lead your treatment team and manage your medical care. Physiatrists (pronounced fiz-EYE-ah-trists) are rehab doctors who lead your treatment team and manage your medical care.
- Psychologists develop and apply treatment strategies in counseling to help you through your adjustment to life after injury.
- Nurses usually carry out the care plan set by your healthcare team, and they often provide the essential education you need on how to manage issues like bowel and bladder care. They also help reinforce what you learn in therapy.
- Physical therapists use a wide variety of techniques to help you regain the strength and stamina to maximize your physical abilities.
- Occupational therapists use a wide variety of techniques to help you increase and maintain your independence in carrying out your daily living activities.
- Recreational therapists use activity-based approaches to improve or maintain physical, cognitive, social, emotional and spiritual functioning to ease the return to everyday life.
- Speech-language pathologists (speech therapists) treat the problems related to communication and swallowing.
- Social workers link you and your family to information and resources that help ease your transition from in-patient rehabilitation to home and community living.

What is my role in rehab?

You will work with your rehab team to set personal goals. These goals will be based on a realistic expectation of what you should be able to do with the muscle movement you have after injury. These goals can change if you regain additional movement over time.

To reach your goals, you have to work as hard as you can to get stronger and learn the skills you need to manage daily activities and be as independent as possible. Some common goals include using a wheelchair, transferring to and from a wheelchair, driving a car, bathing, eating, and dressing.

Also, learn as much as you can about how to take care of yourself. Learn how to manage your daily concerns, such as bladder and bowel. Learn how to best prevent health problems like pressure injuries, urinary tract infections, and pneumonia. Learn what you should do if you develop pain, autonomic dysreflexia, depression, or other medical problems.

- Learning how to take care of yourself also includes learning to direct others to assist with care when needed.



What advice can be offered from other people with SCI about rehab?

People who have been injured and gone through rehab understand what you and your family are experiencing. They have been where you are now, and they can offer some valuable suggestions to help guide you during rehab. They offer the following advice.

- Trust your rehab team. Think of rehab team as a source of knowledge in your care and put trust in their advice. They can be key partners who work with you to help you set and reach your goals. They can also advise you on how to best avoid many of the common setbacks people experience during rehab. One example is that your rehab team will advise you on how often to do a weight shift (also known as pressure relief). This is important because most pressure injuries can be prevented but can severely limit your ability to participate in rehab and other activities if you get one.
- Remember that *who* you are does not change after injury. You have the love and support of your family, friends, and others in your community. They can be a valuable support network in helping you reach your goals.
- Approach rehab with a balanced mindset. Everyone hopes they will regain all of their lost movement and feeling. However, the reality is that people are more likely to regain some, but not all, movement and feeling. This makes it very important that you participate in rehab to learn the skills necessary to have the healthiest and happiest life after SCI. Attending education classes will help you learn about SCI and how to take care of yourself. If you do regain everything, you have lost nothing in the process of learning those skills. If you do not regain everything, you will have the valuable knowledge and skills you need for everyday living.
- Be patient. SCI is a life-changing event. It takes time to rebuild your life after injury, and your body will need time to heal from the trauma of your injury. You will need time to regain the strength and stamina to reach your goals. However, you can do it in time.
- You will have bad days. It is only natural to feel sad, angry, or afraid at times. There may be times when it is hard to imagine how you can ever be happy after injury. However, most people do find happiness over time as they begin to realize they can live an active, healthy life.
- Take advantage of peer support. Your rehab team can likely arrange for you to talk with others who have SCI. They have been where you are and learned how to manage day-to-day activities. They can be a valuable source of information. There are also some online support networks. Here are a couple of recommended sites that have a focus in peer support.
 - www.spinalcord.org provides information and resources to meet the needs of people with SCI and their families and friends.
 - www.facingdisability.com is designed to provide Internet-based information and support for people with SCI and their families. The website has more than 1,000 videos of family members answering real-life questions about how they cope with SCI.
- Ask questions. You will probably have many questions. If you have questions, ask your rehab team. Most questions can be answered, but there may be some questions that cannot be answered. When it comes to regaining movement after injury, for example, sometimes it just takes time to see what happens.



What are my functional goals?

The chart on the following pages outlines the minimum goals that are reasonable for someone with a complete injury at the given levels of injury. This means the goals are expected if there is little to no muscle movement below that level. You may set additional goals if you have muscle movement below that level or you can do more with new and advancing adaptive and assistive technologies.

- You will work with your rehab team to set your own personal functional goals and find ways to reach your goals.
- New and advancing adaptive and assistive technologies continue to greatly enhance functional abilities, especially for those with more limited muscle movement. It can be in your best interest to stay informed on new and advancing adaptive and assistive technologies to continue to enhance your functional abilities.

Reading the Functional Goals Chart

- Find your level of injury in the “Level of Injury” column.
- The “Expected Muscle Control” column shows the minimum muscle movement you are expected to have at that level of injury. This is if you have little to no muscle movement below that level.
- The “Functional Goals” column outlines which activities are expected to be done with that level of injury and little to no movement below that level. You may be able to set additional goals if you gain better muscle control or can do more with new and advancing adaptive and assistive technologies.
- The “What is Needed” column offers suggestions for medical equipment, adaptive devices, assistive devices, and assistive technologies that might be helpful in achieving those goals.
 - Search the internet to find any items listed in the chart.
 - Some suggestions include items that may not be covered by insurance and must be paid using out-of-pocket expenses.



Level of Injury	Expected Muscle Control	Functional Goals	What is Needed
C2-C4	C2-C3 – Limited movement of head and neck. C4 – Added shoulder shrugs.	<p>Breathing <u>C2-C3</u> Depends on ventilator. <u>C4</u> May initially need a ventilator, but most adjust to breathing without a ventilator.</p>	<p><u>C2-C3</u></p> <ul style="list-style-type: none"> Suction equipment to clear secretions. Two ventilators with a generator and battery on hand as a backup in the event of power loss. <p><u>C4</u></p> <ul style="list-style-type: none"> Cough assist device
		<p>Communication <u>C2-C3</u> Talking is sometimes difficult, very limited, or impossible. If the ability to talk is impaired, typing and communication can be accomplished independently with setup assistance of synthesized speech device, smartphones, tablets, and computers. <u>C4</u> Talking is normal.</p>	<p><u>Impaired Voice</u></p> <ul style="list-style-type: none"> Synthesized speech device Sip and puff switch activated attendant call chime. Computer with camera and eye-gaze or motion-tracking technology. Mouth stick for physical touch typing. A stylus on mouth stick can be used for smartphone, tablet, and computer touchscreen use. <p><u>Non-Impaired Voice</u></p> <ul style="list-style-type: none"> Microphone with voice recognition software Mouth stick for physical touch typing. A stylus on mouth stick can be used for smartphone, tablet, and computer touchscreens.
		<p>Daily tasks With setup assistance, advancing technologies with smart devices paired with smartphones, tablets, or computers can allow independent environmental control when in bed or sitting in a wheelchair. This includes, but is not limited to, independent control of a TV, cable or satellite box, audio and multimedia systems, thermostat, electric door opener, door locks, cameras, and power on/off devices such as lights and appliances. Full assistance is needed for all self-care, including eating, daily skin checks, bathing and bowel and bladder management.</p>	<p><u>Bathing</u></p> <ul style="list-style-type: none"> Padded shower commode chair, may have tilt-in-space option. <p><u>Eating and Drinking</u></p> <ul style="list-style-type: none"> Extra-long, flexible drinking straw or hands free drinking system. <p><u>Environmental Control</u></p> <ul style="list-style-type: none"> Smartphone and tablet with voice recognition, a mouth stick with a stylus, and/or smart phone accessibility features. Bed and wheelchair phone mounts. Bluetooth earpiece with speech recognition for placing and answering calls. Computer access with speech recognition software/microphone, adapted mouse options controlled with head movement or a joystick. Wheelchair trays, height adjustable workstations. Bluetooth and Infrared assistive technologies built into power wheelchair controls. Cloud-based smart speaker for voice control if voice (speech devices can function as voice) Connected smart devices using WIFI network, smart hubs, smart plugs and switches, and other smart home devices.

Level of Injury	Expected Muscle Control	Functional Goals	What is Needed
C2-C4	C2-C3 – Limited movement of head and neck. C4 – Added shoulder shrugs.	<p>Mobility Can operate a power wheelchair using a head control, sip and puff, or chin control. Can use a power seating system for independent pressure relief while sitting.</p> <p>Full assistance is needed for transfers and pressure relief turning in bed, but a power rotation bed can be used for turning in bed.</p>	<ul style="list-style-type: none"> • Power or manual lift for transfers • Although an electric or semi-electric hospital bed is most common, a power rotation bed • Power wheelchair with power tilt and recline seating system • Skin protection and positioning cushion
C5	Added ability to bend elbows and turn palms face up.	<p>Breathing Full to partial cough assist is needed to clear secretions.</p> <p>Daily Tasks After setup assistance, can expect to be fully independent with eating and brushing teeth. After setup assistance, may also be full to partially independent with some upper body dressing, some bathing, some grooming, and some make-up application.</p> <p>With setup assistance and when in a wheelchair, can usually have independent environmental control of smartphone, tablet, computer, TV, cable or satellite box, audio and multimedia systems, thermostat, electric door opener, door lock, cameras, and lowered light switches. and appliances, and other connected devices. With setup assistance, smart home technologies can be used for independent environmental control when in bed.</p> <p>Full assistance is needed for daily skin checks, bowel, and bladder management. After setup assistance, a manual or power leg bag emptier can be setup for independent emptying while in wheelchair.</p>	<ul style="list-style-type: none"> • Cough-assist device recommended, but a manual cough assist can be used <p><u>Leg bag (if used)</u></p> <ul style="list-style-type: none"> • Manual or power leg bag emptier <p><u>Eating and Drinking</u></p> <ul style="list-style-type: none"> • Extra-long, flexible drinking straw • Assistive cuff for attachment of utensils • Cup with handle • High rim plate, scoop plate or plate guard <p><u>Grooming</u></p> <ul style="list-style-type: none"> • Assistive cuff for attachment of tooth brush, comb/brush, razor, makeup applicators <p><u>Bathing</u></p> <ul style="list-style-type: none"> • Wash mitt • Assistive cuff with long handle loofah or sponge • Padded shower commode chair, may have tilt-space option <p><u>Environmental Control</u></p> <ul style="list-style-type: none"> • Smartphone and tablet with voice recognition, a stylus in a cuff, and/or smart phone accessibility features. • Bed and wheelchair phone mounts. • Computer access with speech recognition software/microphone, trackball or wheelchair joystick mouse options. • Wheelchair trays, height adjustable workstations. • A stylus can be used with an assistive cuff for physical touchscreen use of smartphone, tablet, and computer. • Cloud-based smart speaker for voice control. • Connected smart devices using WIFI network, smart hubs, smart plugs and switches, and other smart home devices.

Level of Injury	Expected Muscle Control	Functional Goals	What is Needed
C5	Added ability to bend elbows and turn palms face up.	<p>Mobility Some to full assistance is needed for transfers and pressure relief turning in bed.</p> <p>A power wheelchair with hand controls will likely be used for daily activities, but some may have the strength to push a manual wheelchair for short distances over level surfaces. Full independence with pressure relief with power tilt and recline seating system, and some may also do front and side-to-side leans for pressure relief in power wheelchair.</p> <p>Some may be able to drive using specialized, adaptive driving controls on a modified, wheelchair accessible van</p>	<p><u>Bed</u></p> <ul style="list-style-type: none"> • Bed ladder, thigh straps, and bed rails • May first use an electric or semi-electric hospital bed, but many transition into a more traditional bed. An adjustable, well-padded, air mattress is suggested. <p><u>Wheelchair</u></p> <ul style="list-style-type: none"> • Power or manual lift for transfers • Power wheelchair with power tilt and recline seating system • Skin protection and positioning cushion <p><u>Driving</u></p> <ul style="list-style-type: none"> • A driving evaluation is required to determine driving controls • Accessible van with ramp or lift and wheelchair lock down system • Chest strap
C6	Added ability to turn palms up and down and extend wrists.	<p>Breathing Full to partial cough assist is needed to clear secretions.</p> <p>Daily Tasks After setup assistance, can expect to be fully independent with feeding, grooming, and upper body bathing and dressing. Can do some light meal preparation tasks. Will need assistance for lower body bathing and dressing.</p> <p>Full assistance is usually needed for daily skin checks, bowel, and bladder management. However, some can gain greater independence over time using assistive devices with management of bowel and bladder. If needed, a leg bag emptier can be setup for independent emptying while sitting in the wheelchair.</p>	<ul style="list-style-type: none"> • Cough-assist device recommended, but a manual cough assist can be used <p><u>Eating and Drinking</u></p> <ul style="list-style-type: none"> • Assistive cuff for attachment of utensils <p><u>Grooming</u></p> <ul style="list-style-type: none"> • Assistive cuff for attachment of tooth brush, comb/brush, razor, makeup applicators <p><u>Dressing</u></p> <ul style="list-style-type: none"> • Assistive cuff with dressing stick • Buttoning aid hook • Zipper pull grip • Leg lifter or leg and thigh lifter <p><u>Bathing</u></p> <ul style="list-style-type: none"> • Wash mitt • Assistive cuff with long handle loofah or sponge • Padded tub bench if transferring into tub • Padded shower commode chair if using a roll-in shower <p><u>Bowel Management</u></p> <ul style="list-style-type: none"> • Drop-arm padded bedside commode • Digital bowel stimulator and suppository inserter <p><u>Bladder Management</u></p> <ul style="list-style-type: none"> • Catheter inserter • Thigh spreader • Adaptive mirror

Level of Injury	Expected Muscle Control	Functional Goals	What is Needed
C6	Added ability to turn palms up and down and extend wrists.	<p>Mobility Can be independent with turning in bed and with transfers over level surfaces. Most will need assistance for uphill transfers.</p> <p>Some may use an ultra-lightweight manual wheelchair for primary mobility, and some will use a power wheelchair for primary mobility for easier mobility over uneven terrain.</p> <p>Manual wheelchair users can do independent front and side-to-side leans for pressure relief. Power wheelchair users can also do pressure relief with power tilt and recline seating system.</p> <p>Independent with driving using adaptive driving controls. Most will use a modified, wheelchair accessible van.</p>	<p><u>Transfers</u></p> <ul style="list-style-type: none"> • Transfer board, thigh straps <p><u>Bed</u></p> <ul style="list-style-type: none"> • Bed ladder, thigh straps, and bed rails used for bed mobility • May first use an electric or semi-electric hospital bed, but many transition out of it and into a more traditional bed. An adjustable, well-padded, air mattress is suggested. <p><u>Manual Wheelchair</u></p> <ul style="list-style-type: none"> • Ultralight manual wheelchair • Wheelchair gloves • Pegs or rubber tubing on push rims • Power-assist device • Skin protection and positioning cushion <p><u>Power Wheelchair</u></p> <ul style="list-style-type: none"> • Power wheelchair with power tilt and recline seating system • Skin protection and positioning cushion <p><u>Driving</u></p> <ul style="list-style-type: none"> • A driving evaluation is required to determine driving controls • Accessible van with ramp or lift and wheelchair lock down system • Torso stability belt
C7	Added ability to straighten elbows.	<p>Breathing Full to partial cough assist is needed to clear secretions.</p> <p>Daily Tasks Can expect to be fully independent with feeding, grooming, and upper body bathing and dressing, and may or may not need assistance for lower body bathing and dressing.</p> <p>With assistive devices, many can be independent with daily skin checks, bowel, and bladder management. Some may need some assistance.</p>	<ul style="list-style-type: none"> • Cough-assist device is sometimes needed, but a manual cough assist is common when needed <p><u>Eating, Drinking, Grooming, Dressing and Bathing</u></p> <ul style="list-style-type: none"> • May first use assistive cuff for attachments, but cuffs may or may not be used for long-term assists <p><u>Dressing</u></p> <ul style="list-style-type: none"> • Dressing stick • Buttoning aid hook • Zipper pull grip • Leg and thigh lifter • Sock aid and long shoe horn <p><u>Bathing</u></p> <ul style="list-style-type: none"> • Long handle loofah or sponge • Padded tub bench if transferring into tub • Padded shower commode chair if using a roll-in shower <p><u>Bowel and Bladder Management</u></p> <ul style="list-style-type: none"> • Drop-arm padded bedside commode • Digital bowel stimulator and suppository inserter • Catheter inserter • Thigh spreader • Adaptive mirror

Level of Injury	Expected Muscle Control	Functional Goals	What is Needed
C7	Added ability to straighten elbows.	<p>Mobility Can be independent with turning in bed and with transfers.</p> <p>An ultra-lightweight manual wheelchair is used for primary mobility.</p> <p>Can do independent lifts, front and side-to-side leans for pressure relief.</p> <p>Independent with driving using adaptive driving controls. Some may be independent in car loading and unloading of manual wheelchair.</p>	<p><u>Transfers</u></p> <ul style="list-style-type: none"> • Transfer board, thigh straps <p><u>Bed</u></p> <ul style="list-style-type: none"> • Bed ladder, thigh straps, and bed rails used for bed mobility • May first use an electric or semi-electric hospital bed, but many transition out of it and into a more traditional bed. An adjustable, well-padded, air mattress is suggested. <p><u>Manual Wheelchair</u></p> <ul style="list-style-type: none"> • Ultralight manual wheelchair • Wheelchair gloves • Rubber tubing on push rims • Power-assist device • Skin protection and positioning cushion <p><u>Driving</u></p> <ul style="list-style-type: none"> • A driving evaluation is recommended, and hand control driving devices are commonly used • Chest strap
C8-T1	Added ability for precise hand and finger movement.	<p>Breathing Self-assist for cough to clear secretions.</p>	
		<p>Daily Tasks Can expect to be independent with all self-care. Some assistive devices may be helpful.</p>	<p><u>Helpful Aid</u></p> <ul style="list-style-type: none"> • Long reacher/grabber <p><u>Dressing</u></p> <ul style="list-style-type: none"> • Dressing stick • Leg and thigh lifter • Sock aid and long shoe horn <p><u>Bathing</u></p> <ul style="list-style-type: none"> • Long handle loofah or sponge • Padded tub bench with cutout or padded shower commode chair <p><u>Bowel and Bladder Management</u></p> <ul style="list-style-type: none"> • Digital bowel stimulator and suppository inserter • Drop-arm padded bedside commode • Thigh spreader • Long handle mirror
		<p>Mobility: Can expect to be independent with manual wheelchair transfers, bed mobility, pressure relief, driving, and car loading and unloading of wheelchair.</p>	<p><u>Transfers</u></p> <ul style="list-style-type: none"> • Transfer board, thigh straps may be needed <p><u>Bed</u></p> <ul style="list-style-type: none"> • Bed ladder, thigh straps, and bed rails <p><u>Manual Wheelchair</u></p> <ul style="list-style-type: none"> • Ultralight manual wheelchair • Wheelchair gloves • Skin protection and positioning cushion <p><u>Driving</u></p> <ul style="list-style-type: none"> • A driving evaluation is recommended, and hand control driving devices are used • Chest strap

Level of Injury	Expected Muscle Control	Functional Goals	What is Needed
T2–L1	Added ability for trunk control with gains in chest muscle control and abdominal muscle control.	Daily Tasks Can expect to be independent with all self-care. Helpful devices may be used, but few to no assistive devices are usually needed.	<u>Helpful Aids</u> <ul style="list-style-type: none"> • Long reacher/grabber • Dressing stick • Leg and thigh lifter • Sock aid and long shoe horn • Long handle loofah or sponge <u>Bathing</u> <ul style="list-style-type: none"> • Padded tub bench with cutout or padded shower commode chair <u>Bowel Management</u> <ul style="list-style-type: none"> • Padded drop-arm bedside commode or padded shower commode chair
		Mobility Can expect to be independent with manual wheelchair transfers, pressure relief, driving, and car loading and unloading of wheelchair. Can expect to be independent with manual wheelchair on all surfaces and up and down curbs.	<u>Transfers</u> <ul style="list-style-type: none"> • Transfer board, thigh straps may be needed <u>Bed</u> <ul style="list-style-type: none"> • Bed ladder, thigh straps, and bed rails <u>Manual Wheelchair</u> <ul style="list-style-type: none"> • Ultralight manual wheelchair • Skin protection and positioning cushion <u>Driving</u> <ul style="list-style-type: none"> • A driving evaluation is recommended, and hand control driving devices are used along with vehicle seatbelt
L2–S1	Added movement in the hips and knees, ankles and toes.	Daily Tasks Fully independent with all self-care and daily activities using no assistive devices.	
		Mobility Higher levels of injury will likely use a manual wheelchair for primary mobility, but many can walk short distances using leg braces and walking devices. Lower levels of injury will likely walk using fewer to no bracing or assistive devices.	<u>Wheelchair</u> <ul style="list-style-type: none"> • Ultralight manual wheelchair if necessary with skin protection and positioning cushion <u>Walking</u> <ul style="list-style-type: none"> • Leg braces that extend to the hip, the knee, or just the ankle/foot and varying assistive devices

Authorship

“Understanding Spinal Cord Injury: Part 2—Recovery and Rehabilitation” was developed by Phil Klebine, MA; Olivia Smitherman, MOTR/L.; Laney Gernenz, PT; and Jill Baldessari, OTR/L, ATP in collaboration with the Model Systems Knowledge Translation Center.

Parts of this document were adapted from materials developed by the UAB SCI Model System, Northwest Regional SCI System, Southeastern Regional Spinal Cord Injury Care System, Rocky Mountain Regional Spinal Injury System, and Paralyzed Veterans of America Consortium for Spinal Cord Medicine.

Factsheet Update

“Understanding Spinal Cord Injury: Part 2—Recovery and Rehabilitation” was reviewed and updated by Phil Klebine, MA; Olivia Smitherman, MOTR/L.; Laney Gernenz, PT; and Jill Baldessari, OTR/L, ATP in collaboration with the Model Systems Knowledge Translation Center.

Source: The content in this factsheet is based on research evidence and/or professional consensus and has been reviewed and approved by an editorial team of experts from the Spinal Cord Injury Model Systems (SCIMS), funded by the National Institute on Disability, Independent Living, and Rehabilitation Research (NIDILRR).

Disclaimer: This information is not meant to replace the advice of a medical professional. You should consult your health care provider regarding specific medical concerns or treatment. This publication was produced by the SCI Model Systems in collaboration with the University of Washington Model Systems Knowledge Translation Center with funding from the National Institute on Disability and Rehabilitation Research in the U.S. Department of Education, grant no. H133A060070. It was updated under the American Institutes for Research Model Systems Knowledge Translation Center, with funding from the National Institute on Disability, Independent Living, and Rehabilitation Research (NIDILRR grant number 90DP0082). NIDILRR is a Center within the Administration for Community Living (ACL), Department of Health and Human Services (HHS). The contents of this factsheet do not necessarily represent the policy of NIDILRR, ACL, or HHS, and you should not assume endorsement by the federal government.

Copyright © 2020 Model Systems Knowledge Translation Center (MSKTC). May be reproduced and distributed freely with appropriate attribution. Prior permission must be obtained for inclusion in fee-based materials.



Urinary Tract Infection and Spinal Cord Injury

March 2017

www.msctc.org/sci/factsheets

SCI Fact Sheet

If you have a spinal cord injury (SCI), you have a higher risk for urinary tract infection (UTI). UTI is one of the most common medical problems after SCI. This fact sheet explains your risk for UTI, how to best prevent it, and what to do if you get it.

What is a urinary tract infection?

A urinary tract infection (UTI) is an infection in your urinary system. This system includes your kidneys, ureters, bladder, and urethra.

What causes UTI?

The most common cause of UTI starts when bacteria enter the bladder through the urethra. The bacteria may multiply in the bladder to become UTI.

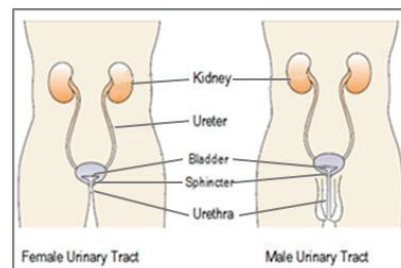

What are bacteria?

Bacteria are tiny, living organisms. Good bacteria in your body help you to digest food and protect you from bad bacteria. Bad bacteria cause infections and make you sick.

Is UTI common after spinal cord injury (SCI)?

Yes. Here are 3 of the more common reasons people with SCI develop UTIs.

1. Most people lose normal urinary function after SCI. They need a bladder management option to empty the urine from their bladder to keep their bladder and kidneys healthy. Most bladder management options make it easier for bacteria to enter the bladder through the urethra.
 - Please read "[Bladder Management Options Following Spinal Cord Injury](#)" to learn more about normal urinary function, how it changes after SCI, and bladder management options.
2. Most people lose normal bowel function after SCI, and contact with stool is common during bowel management. Stool has bacteria that can cause a UTI. UTIs are often caused when bacteria from stool gets into the bladder when the bladder is being emptied.
 - Please read "[Bowel Function after Spinal Cord Injury](#)" to learn more about normal bowel function, how it changes after SCI, and bowel management options.
3. Once in the bladder, bacteria are hard to get rid of. People with normal bladder function can usually get rid of most bacteria by fully emptying their bladder when they urinate. However, many people with SCI can't fully empty their bladder, even with good bladder management. This allows bacteria to stay in the bladder almost all of the time, making it easier for a UTI to develop.

What is my risk for UTI?

Anyone can get UTI. However, people with SCI have a higher risk than normal.

- People with SCI who use an indwelling Foley or suprapubic catheter may be at higher risk for UTI than those who use a clean intermittent catheterization technique or have an external sheath or condom catheter.
 - Talk to your health professional about lowering your risk for UTI if you average more than one UTI per year. Your health professional may suggest another method of bladder management that works better for you.
- Women may be at a higher risk for UTI than men because a woman's urethra (see diagram above) is shorter and located closer to the anus. This can make it easier for bacteria from the colon to enter the bladder through the urethra.

The contents of this fact sheet are based on research evidence and/or professional consensus and has been reviewed and approved by an editorial team of experts from the Spinal Cord Injury Model Systems, which is sponsored by the National Institute on Disability, Independent Living, and Rehabilitation Research (See www.msctc.org/sci/model-system-centers for more information).



Can I prevent UTIs?

Most people with SCI get UTIs. Even if you can't avoid UTIs, you can do a few basic practices to reduce your chances of getting them.

Prevent your bladder from getting too full

Empty your bladder when needed. Empty it completely each time. This will help to reduce your chances of developing two common problems that increase your risk for UTI.

1. Over-distended bladder—Your bladder becomes over-stretched when it holds too much urine. This damages the bladder wall and forces the urine back into the ureters and kidneys.
2. Bladder or kidney stones—Excess sediment and calcium in urine can form into stones that can restrict the flow of urine.

Get plenty of water

Your body needs the proper amount of water to stay hydrated and healthy. Here are a few of the vital health benefits from staying hydrated:

- Helps to flush out bacteria from the bladder
- Helps to maintain body temperature
- Helps to ease the flow of stool through the bowel
- Helps to keep the skin moist, supple, and healthy

Your body absorbs a small amount of water from the foods you eat. But what you drink is your body's main source of water. This is why you need to drink plenty of water. The color of your urine can help guide you in getting enough water. Ideally, your urine should be golden yellow. You probably need to drink more water if your urine is darker. Here is a color guide to help you. →



- Your diet and certain medications, including dietary supplements, can affect the color of your urine. For example, blackberries, beets, and rhubarb can turn urine darker. Vitamin B can turn urine bright yellow.
- Talk to your health professional before you change the amount of water you drink. You may need to adjust your bladder management. For example, you may need to empty your bladder more often if you increase the amount of water you drink.

Eat healthy and exercise

A healthy diet and exercise are two of the best ways for most everyone with SCI to boost their immune system. A healthy immune system helps you to fight off infections.

- Ask your health professional for advice before starting an exercise program or changing your diet.
- Consider taking vitamin and mineral supplements. Zinc; magnesium; and vitamins A, B6, B12, C, D, and E may help to boost your immune system. Ask your health professional for advice before taking any supplements.

Proper Hygiene

Staying clean is a good way to prevent the spread of bacteria. Always wash and clean properly both before and after bladder and bowel management and after accidents.

Take a cranberry pill

Many people insist that cranberries help to prevent UTIs. But research is mixed on the benefits of cranberries. If you think it helps, take a daily cranberry pill instead of drinking the juice. This way you get the benefits of cranberries without the added sugar that is found in most juices.

Watch for early signs of infection

You may notice warning signs before you start to experience symptoms of UTI.

- Gritty sediment in the urine.
- Mucus in the urine. This is often a sign of high levels of bacteria in the urine.
- Dark, cloudy or bad smelling urine.

If you notice any of these, you might be able to fend off UTI.

- Cut back on drinking liquids with alcohol, caffeine, and sugar.
- Drink more water to help wash out more of the bacteria
- If you do intermittent catheterization, do it more often. If you use an indwelling catheter, change it. Consider changing it again after the early signs of infection have gone away.

Should I take antibiotics to prevent UTI?

Not usually. Antibiotics are medicines used to kill bacteria that cause infection. When you take an antibiotic to kill bacteria, the bacteria can change or adapt in a way that it becomes “resistant” to the antibiotic being used. This means that the antibiotic can no longer kill the bacteria. It takes a stronger antibiotic to then kill the bacteria in the future. There are a limited number of antibiotics that can kill bacteria, so it’s best to use antibiotics only when needed to avoid reaching the point when the bacteria are resistant to all antibiotics.

Here are a few recommendations for using antibiotics and better avoiding antibiotic resistance.

- Do not take antibiotics that are not prescribed to you.
- Do not take antibiotics for conditions that do not require them. For example, don’t take antibiotics to treat viruses like the cold or flu.
- Do not take antibiotics simply because your urine has bacteria. It is very common for people with SCI to have bacteria in their urine, so you usually only need to take an antibiotic to treat a UTI when you begin to have signs and symptoms.
 - Antibiotics may be used to prevent infection in some situations. For example, women with SCI are often prescribed antibiotics to prevent UTI during pregnancy.

What are the signs and symptoms of UTI?

You may have UTI if you start having one or more of these signs or symptoms.

- Fever (usually at least 100°F or 38°C)
- Chills
- Nausea
- Headache
- Urine with mucus and/or sediment
- Feeling tired or sluggish
- Changes in muscle spasms
- Dark or cloudy urine and/or urine that smells bad
- Lower back pain, if you have sensation in that area
- Autonomic dysreflexia, if your injury is T6 or above

What should I do if I have signs and symptoms of UTI?

- Contact your health professional right away for advice on treatment.
- Always provide your health professional with a urine sample for testing. The test results are needed to prescribe the most effective antibiotic to treat the specific bacteria that is causing the UTI. The test also helps to make sure that the infection is not being caused by other health problems.
 - Collect the urine sample in a sterile cup using a sterile catheter. Do not collect the urine from a leg bag or night bag.
 - After you’ve collected your urine sample, give it directly to your health professional within 2 hours of being collected. If there is a delay, keep the sample cool or refrigerated.
- Take the antibiotic exactly as prescribed and over the prescribed time frame. Do not stop taking it when you begin to feel better.
- Drink plenty of water to wash out more of the bacteria. Stop drinking liquids with alcohol, caffeine, and sugar.
 - Ask your health professional if intermittent catheterization should be done more often than normal.
- Contact your health professional if you continue to have signs or symptoms of infection after you finish taking the antibiotic.

Authorship

Urinary Tract Infection and Spinal Cord Injury was developed by Phil Klebine, M.A., and Keneshia Kirksey, M.D., in collaboration with the Model Systems Knowledge Translation Center.

Source: Portions of this document were adapted from materials developed by the UAB SCI Model System and Rocky Mountain Regional Spinal Injury System.

Disclaimer: This information is not meant to replace the advice of a medical professional. You should consult your health care provider regarding specific medical concerns or treatment. The contents of this fact sheet were developed under a grant (number 90DP0012) from the National Institute on Disability, Independent Living, and Rehabilitation Research (NIDILRR). NIDILRR is a Center within the Administration for Community Living (ACL), U.S. Department of Health and Human Services (HHS). The contents of this fact sheet do not necessarily represent the policy of NIDILRR, ACL, and HHS, and you should not assume endorsement by the federal government.

Copyright ©2017 Model Systems Knowledge Translation Center (MSKTC). May be reproduced and distributed freely with appropriate attribution.







Model Systems
Knowledge Translation
Center

